

TAS5733L Evaluation Module

This user's guide describes the operation of the TAS5733L evaluation module (EVM). The EVM is connected to the PurePath™ Console Motherboard (PPCMB) and is configured using PurePath Console 3 (PPC3) software. Visit the [e2e Audio Amplifiers](#) forum for questions and other support issues.

The main contents of this document are:

- Details for properly connecting a TAS5733L evaluation module (EVM) and the details of the EVM
- Start-up procedure using PurePath Console 3 (PPC3) software with the correct plugin for the EVM
- Quick-start guide for the common modes in which the TAS5733LEVM is used

Throughout this document, the abbreviation EVM and the term evaluation module are synonymous with the TAS5733LEVM evaluation module, unless otherwise noted.

Contents

1	Overview	2
2	EVM Setup.....	3
3	Using the TAS5733LEVM with PurePath Console 3.....	4
4	Board Layout, Bill of Materials, and Schematic	14

List of Figures

1	TAS5733L Evaluation Board	2
2	Evaluation Module and PurePath Console Motherboard Connection	3
3	TAS5733L Application in PurePath Console 3.....	4
4	TAS5733L Application Home Window	5
5	TAS5733LEVM Audio Processing Windows	7
6	Equalizer Window.....	8
7	Multiband AGL – Three-Band Crossover	9
8	Full-Band AGL	11
9	TAS5733LEVM	14
10	TAS5733L Layout	14
11	Bottom Layer Thermal Flow	15
12	TAS5733LEVM Optional Features	15
13	TAS5733LEVM Top Composite	16
14	TAS5733LEVM Top Layer	16
15	TAS5733LEVM Ground Layer.....	17
16	TAS5733LEVM Power Layer	17
17	TAS5733LEVM Bottom Layer	18
18	TAS5733LEVM Bottom Composite	18
19	TAS5733LEVM Stereo Device	21
20	TAS5733LEVM Mono Device.....	22
21	TAS5733LEVM PPCMB and Power Supply Connection	23

List of Tables

1	Available Sample Rates for Each Digital Input	6
2	Available Presets for Multiband AGL.....	9
3	TAS5733LEVM Bill of Materials	19

1 Overview

The TAS5733L evaluation module showcases the latest TI digital input Class-D open-loop amplifiers. The TAS5733L is an I²S input Class-D amplifier with audio processing features.

The EVM is configured in *Two-Device 2.1* mode with one stereo device using bridge tied load for left and right channels and one mono device configured for mono applications, such as higher power full-range speakers or subwoofers. The EVM is used in conjunction with the PurePath Console Motherboard (PPCMB). The PVDD supply is input on the EVM daughter card, which passes it to the PPCMB motherboard through the J4 connector. Regulators on the PPCMB create the 3.3-V power supply, which is sent back to the DUT through the J4 connector. The EVM is controlled by PPC3 software.

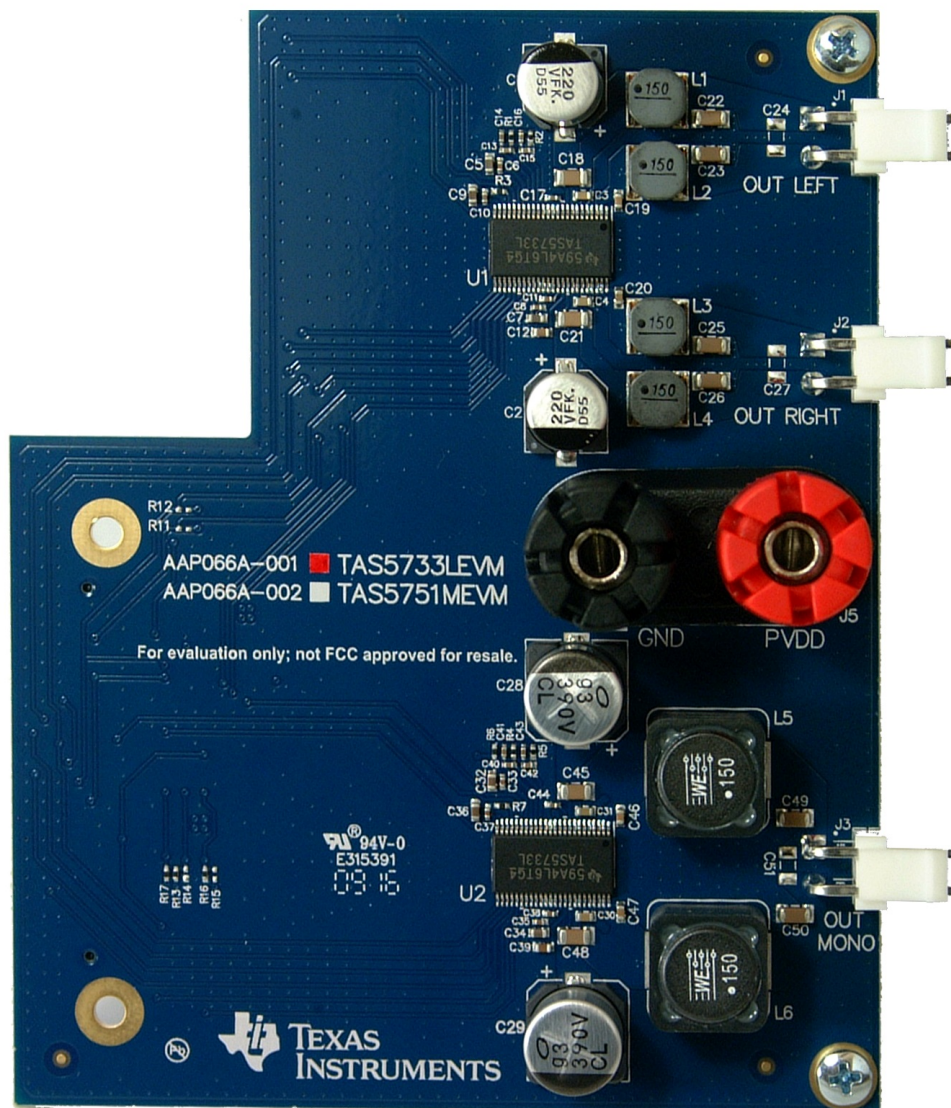

Figure 1. TAS5733L Evaluation Board

1.1 Features

This EVM supports the following features:

- Control via USB port using TI's PPC3
- Two-Device 2.1 mode, one stereo device and one mono device, both with I²S input from PPCMB
- Analog, optical, coaxial, and USB audio inputs available through PPCMB

2 EVM Setup

Figure 2 illustrates the EVM setup.

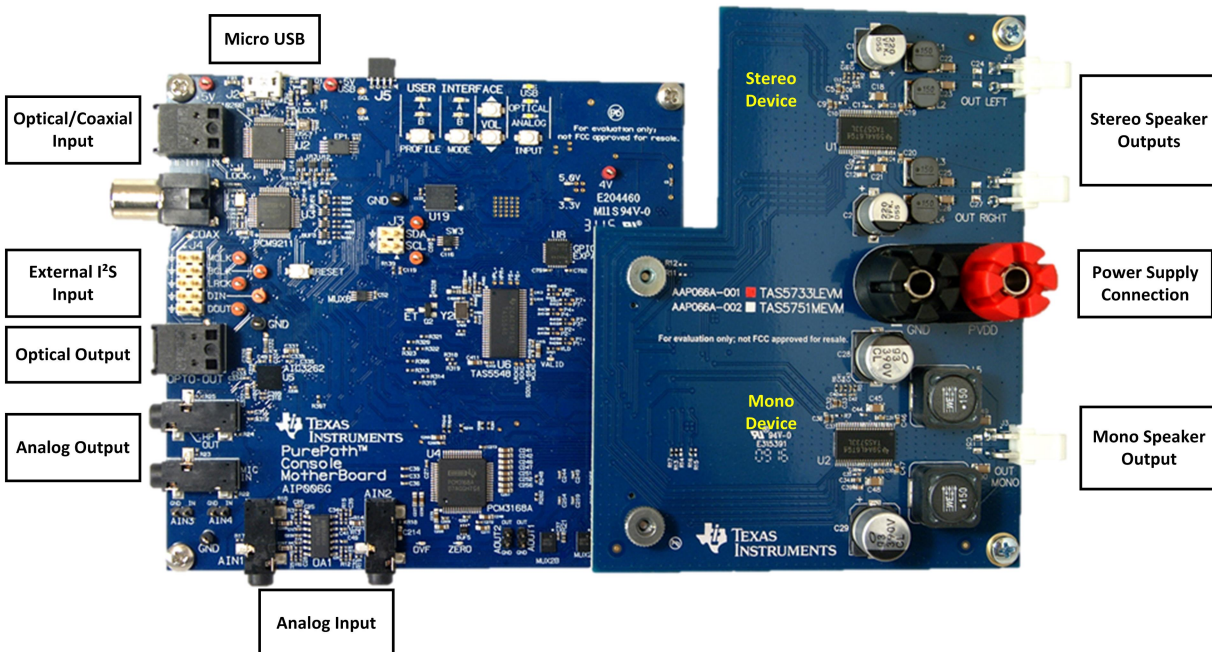

Figure 2. Evaluation Module and PurePath Console Motherboard Connection

2.1 Requirements

The following are required to operate and test this EVM:

- TAS5733LEVM board
- *PurePath Console* motherboard
- Banana cable, or bare wire lead pair for PVDD/GND connection via five-way binding posts.
- Speaker cable with JST VHR-2N connector
- 2 × 8-Ω speakers for stereo test
- 1 × 4-Ω speakers for mono test
- Power supply (8 V to 16.5 V)
- Audio Source (Analog, USB, Optical)
- Micro type-B USB cable
- *PurePath Console* 3.xx GUI running on a PC

2.2 Software Setup

PurePath Console 3.xx is required to configure the EVM. Download the software from www.ti.com/mysecuresoftware, and install it before connecting the device for the first time.

Prior authorization is required to download the software. Access <http://www.ti.com/tool/purepathconsole> and click the **Request** button to start the approval process. TAS5733L application for PurePath Console should be requested from the [TAS5733LEVM tool folder](#).

For more information about PurePath Console 3, refer to the *PPC3 User Manual* and *PPC3 Quick Reference Guide* found in www.ti.com/mysecuresoftware.

2.3 Hardware Setup

Use the following steps to setup the hardware:

- Connect the TAS5733LEVM to the PPCMB.
- Connect the power supply to the EVM board and turn on the power. The 5-V and 3.3-V LEDs will become illuminated.
- Connect the micro-USB cable from the PC to the controller board; the USB lock LED will become illuminated.
- Connect an audio source to the PPCMB, this is not necessary if the source is USB audio.
- Connect the speakers to the outputs of the EVM.

3 Using the TAS5733LEVM with PurePath Console 3

3.1 TAS5733L Application Connection

The TAS5733L application is available in PPC3 after correct installation and approval. Sign into PPC3 to gain access to the TAS5733L application installer. After installing, the TAS5733L application is available.

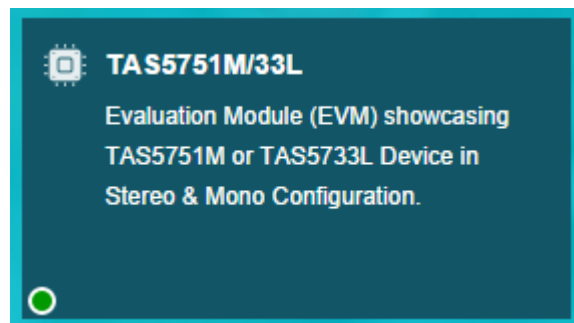

Figure 3. TAS5733L Application in PurePath Console 3

Verify that the EVM is properly connected to the application by looking in the lower left corner of the TAS5733L application. A green status circle indicates that the TAS5733LEVM is properly connected to the computer. The device programming is done automatically when opening the application. If the status circle is not green, the EVM may be connected but it is likely not correctly programmed as the TAS5733LEVM. In this case, connection to the EVM must be done manually by clicking on the **Connect** button located on the lower left corner of the window after opening the TAS5733L application.

When opening the TAS5733L application, a file window appears offering the option to load a previously saved configuration file, start a new configuration or continue the last session. After this, select TAS5733L from the highlighted drop-down menu.

3.2 TAS5733L Application Features

The *Home* window is displayed when the TAS5733L application is initialized. Several evaluation and integration options are available. TI recommends using the application walkthrough by clicking on the question mark icon available next to the page name in all pages. The application walkthrough feature provides guidance through various sections in the selected page and displays comments explaining the sections of the page. Close the application walkthrough at any time by clicking on the 'x' mark at the top right corner of the pop up. Navigate through the previous and next sections in the page by clicking on the left or right arrows.

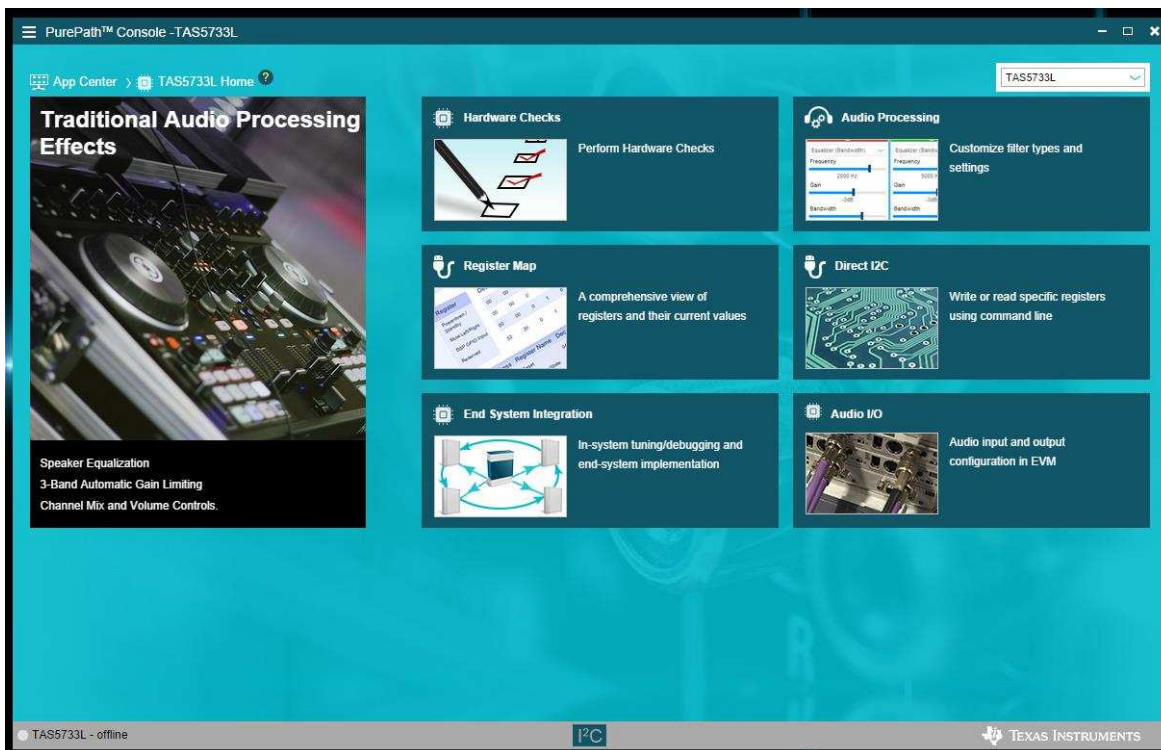
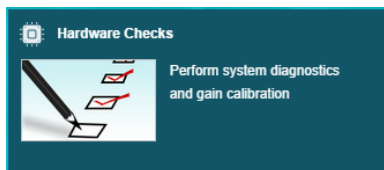

Figure 4. TAS5733L Application Home Window

3.3 Hardware Checks

The following window verifies the correct connection of the evaluation module, checking if the hardware is correctly configured to test the EVM.



Perform a system calibration before proceeding to the *Tuning and Audio Processing* window. If an attempt to enter the *Tuning and Audio Processing* window is made before performing hardware checks, PPC3 prompts with a window requesting to perform the verification of the hardware. Only new sessions require a hardware check, so this window will not appear when continuing from a previous session or loading a previously saved one.

Ensure that the PurePath Console motherboard and EVM are recognized as USB-AudioEVM, and that the sampling frequency is set to 48 kHz. Otherwise, the hardware check fails and the EVM evaluation may not be correct. This information is found under sound settings in the control panel of the host computer.

3.4 Audio I/O



This tool selects the desired audio input to test the board. USB, optical, coaxial, and line inputs are supported by the motherboard. USB audio source is selected as default but there is an option to enable or disable the audio source to the amplifier by clicking on *Speaker out*. The available sampling rates for each digital input are shown in [Table 1](#).

Table 1. Available Sample Rates for Each Digital Input

Input	Sampling rates available
USB in	48 kHz
Optical In	48 kHz / 44.1 kHz
Coax In	48 kHz / 44.1 kHz

Although PPCMB operating range is up to 192 kHz, the available sample rates are limited to the TAS5733L.

3.5 Tuning and Audio Processing

The main features of the amplifier audio processing are configured through this window. After opening the *Tuning and Audio Processing* window, the devices in the EVM are configured with default settings. USB audio is selected as the audio source by default. Configuration options include which device on the board (either stereo or mono) is being configured, the audio source for the amplifiers, as well as the audio processing features available in the device. The option to save the changes made during the audio tuning using the snapshot feature of PPC3 is also available.

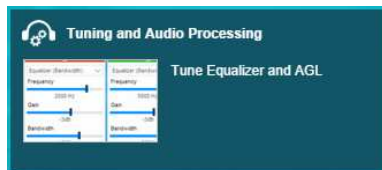

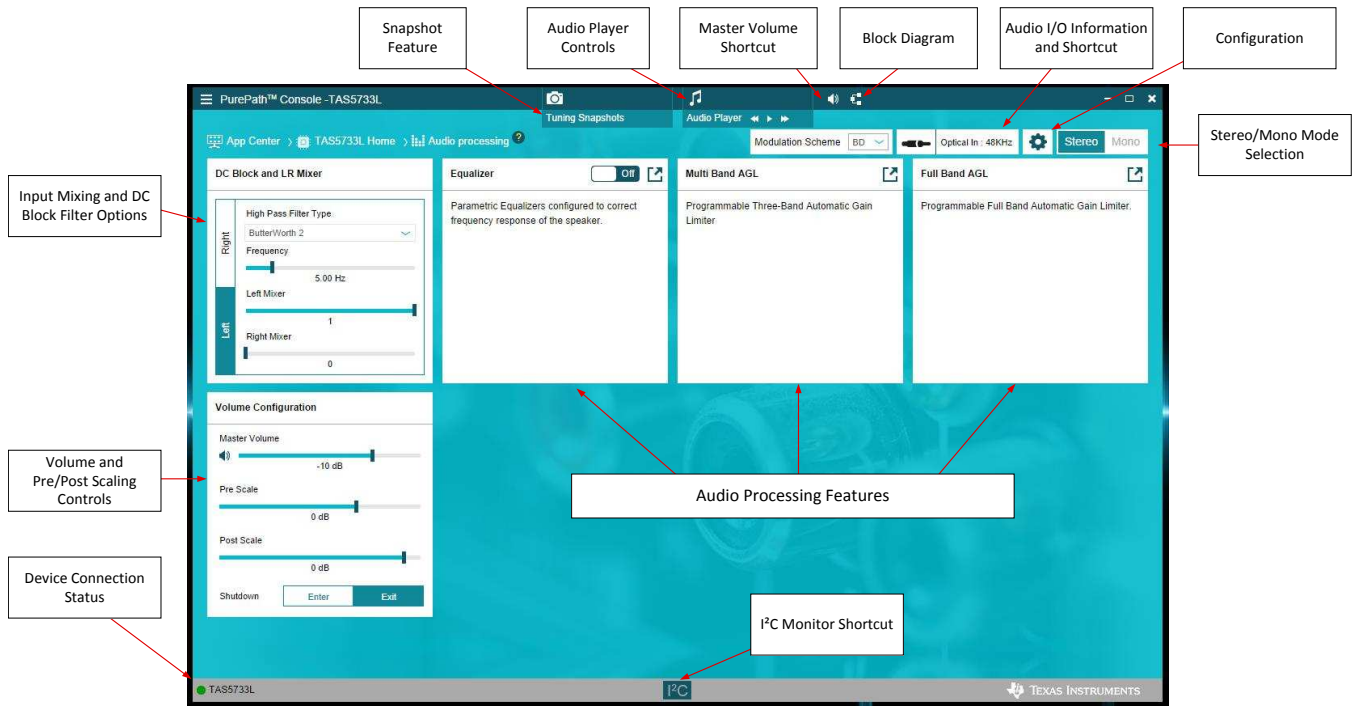

Figure 5. TAS5733LEVM Audio Processing Windows

Stereo/Mono device selection

Configure each device of the EVM individually by selecting between **Stereo** and **Mono** on the upper right section of the *Audio Processing* window. The configuration of each device is made with the same controls; the only difference is that when configuring the mono device, the channel (left or right) driving the power stage is selected. Detailed information is found in the **Configuration** section.



Configuration

Access the configuration menu by clicking in the gear icon next to the **Stereo/Mono selection** button. In Stereo mode, only the option to reset the tuning done in the GUI is offered, in mono mode, the user can select also if the left or right channel from the digital audio processor drives the power stage of the amplifier. When performing the Reset tuning function, the devices are configured with the default settings. By default, both devices are configured with a master volume gain of -10 dB, multiband AGLs are set to 0 dB while full band AGL is set to -1 dB. Stereo device equalizers are turned off, but mono device has a default-configured 120-Hz low-pass filter for use in subwoofer applications. The left channel of the mono device is driving the power stage by default.



Audio I/O shortcut

This section shows the audio source and sampling frequency that is used to generate the I²S input for the TAS5733L amplifiers. The user is redirected to the main Audio I/O window after clicking this button.



Audio Player

The Audio Player is used to play audio tracks available in the PC and perform various tuning operations. Clicking on the Audio Player launches a floating window, where audio tracks are added or played.



Tuning Snapshots

Tuning Snapshot stores all the values of the current setting. A maximum of 5 Snapshots can be stored. When clicking on Tuning Snapshots, the Tuning History Navigator is opened. Tuning History Navigator saves the history of the tuning changes with each node corresponding to a single tune setting changed from the previous node. More information about Tuning History Navigator and Tuning Snapshots is found in the PPC3 User Manual.

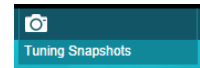

I²C Monitor

Use the *I²C Monitor* to execute direct read and write commands to the device and view the I²C transactions happening as a result of device operation performed using the PPC3 application. *I²C Monitor* has the same functionality of the Direct I²C tool available in the *Home* window of the application. Access the *I²C Monitor* by clicking the I²C Monitor icon in the bottom bar, in any of the pages.



Equalizer

The Equalizer window allows the configuration and setting of the different Biquads available in the audio processing of the device. By default, all the equalizers are turned off in the stereo device, while for the mono device, a 120-Hz low pass filter is implemented by default with EQ1.



Figure 6. Equalizer Window

Different equalizer types can be implemented and all the changes to them are reflected in the different plots. Composite plot (red) reflects the sum response of all the equalizers configured. The details of each equalizer setting (as filter type, frequency, gain, and phase) is found in the bottom of the chart section. Each equalizer is turned on or off independently and offer the option of reading or writing the BQ coefficients directly by clicking in the turn (↻) icon. The setting of the equalizers is ganged for left and right channels by default, but can be configured independently by the user when de-selecting “Ganged” box. *Phase*, *Group Delay*, *Impulse Response*, and pole/zero charts are available as well for the analysis of the equalizer response.

Multiband AGL and Full-Band AGL

The TAS5733L features three multiband AGLs, as well as a full-band AGL. The multiband AGL is used as a three-band crossover, having an independent custom configuration for low, high, and mid frequency bands.

The multiband AGL and full-band AGL also offer the option to use preset configurations based on output power, available for the use of standard power supplies and loads. These presets offer a good starting point towards the full configuration of the end system.

Table 2. Available Presets for Multiband AGL

TAS5733L Presets
15 W with 12-V PVDD, 4-Ω load
10 W with 12-V PVDD, 4-Ω load

The filters used for the multiband AGL crossover are configured according to the specific need. By default, the three-band crossover frequencies are set to 300 Hz and 3 kHz, using second-order Linkwitz-Riley filters. This filter type was chosen so the total sum of the three-band signals has a flat response without having to calculate individual cross-over frequencies for unity summation. The crossover frequencies were selected so they are separated far enough in the frequency range from each other to avoid any dip caused by the filter sum response. For the mid-band mixer, the coefficients range is different and features negative values. This is done because when using second order filters to form a band-pass filter; the phase of the signal is inverted, causing an undesired frequency response when summing all the signals. This phase inversion is corrected by using negative coefficients for the mid-band mixer.

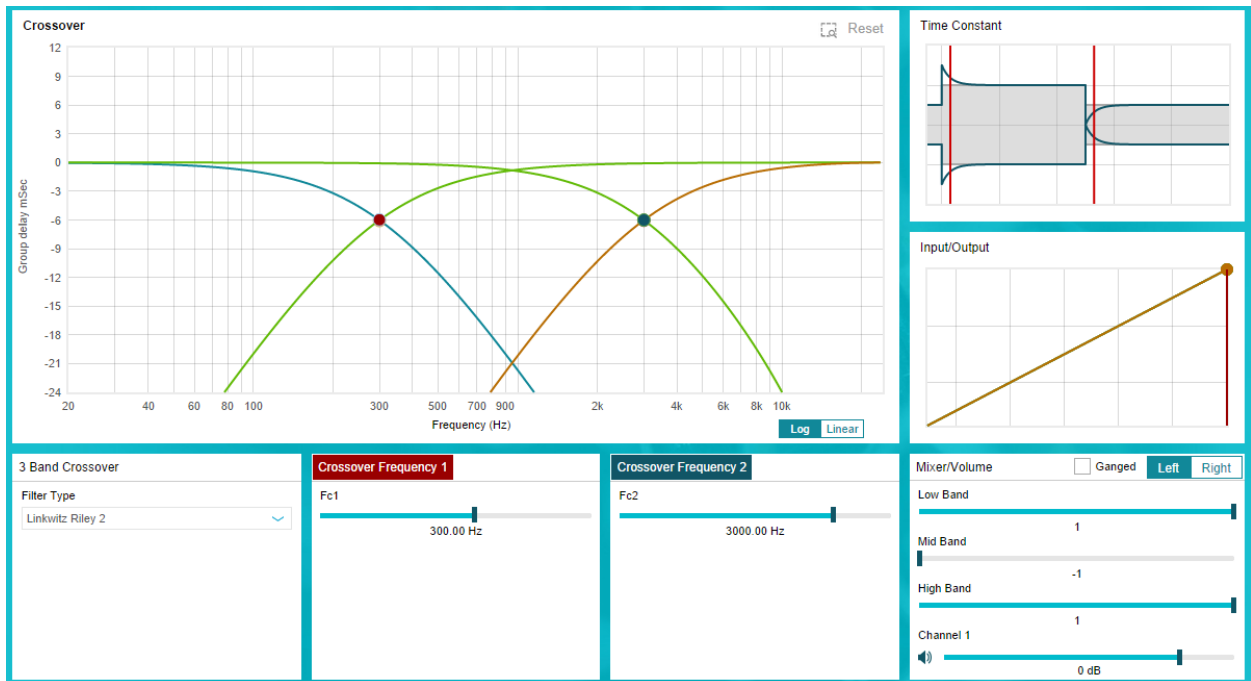
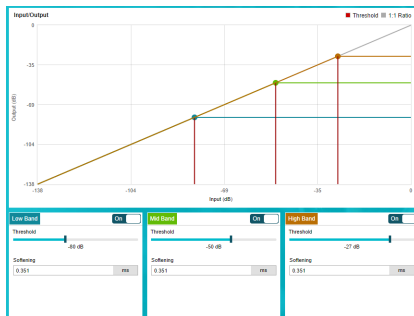
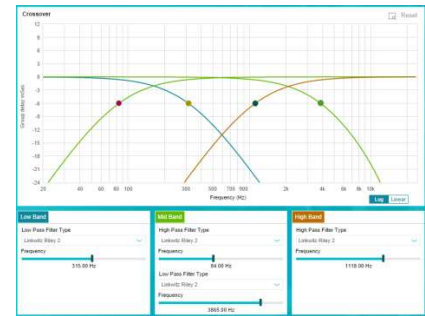

Figure 7. Multiband AGL – Three-Band Crossover

The AGL crossover configuration has two operating modes that can be selected on the top of the main plot:
 In basic mode, the crossover frequencies are ganged for left and right channels, and the filters are configured so cutoff frequencies for lowpass, bandpass, and highpass filter are matched.
 In advanced mode, the user can modify these parameters individually as well as have a different configuration for left and right channels for the stereo device.



An *Input/Output* chart is available to easily configure the threshold levels for each band. Drag and select each threshold and fine tune the desired threshold level by controlling the levels in the lower part of the window. Modify the *Softening* parameter to configure the sharpness of the compression knee of the AGL.

Attack and release parameters are available for AGL tuning:
Attack Rate: This parameter sets the rate of the attack over the output signal when it is greater than the desired threshold level. This parameter acts fast enough to avoid apparent clipping before engaging.
Release Rate: When the threshold is raised, this parameter reflects the release rate of the compressed signal.



All the multiband AGL functions are also featured in the full-band AGL window. By default, -1 dB is configured for full-band AGL and the attack and release rates are set to 10 V/ms.

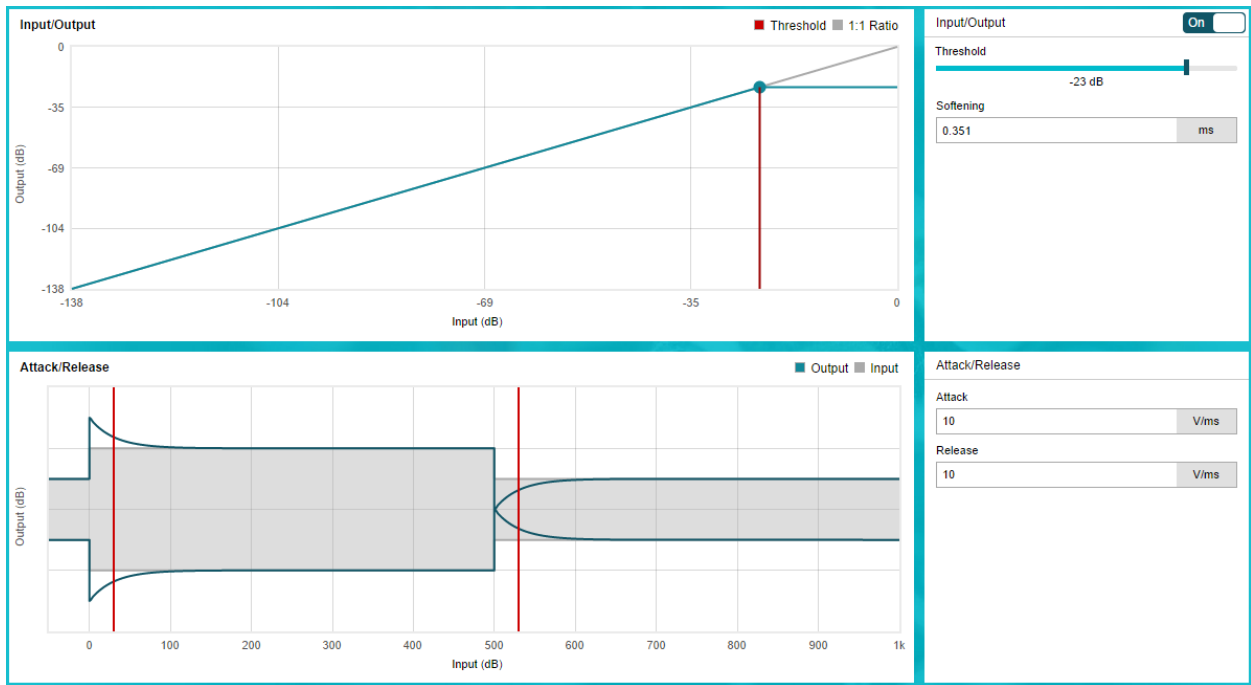

Figure 8. Full-Band AGL

3.6 Register Map

This window is used to monitor and change the main registers of the amplifier.



The readings appearing on the registers are related to the selected device, that is, stereo or mono. Manual changes to the register values is accomplished by double-clicking in the desired bit to change. Clicking on *Read All Registers* allows monitoring of the register status of the amplifier. The *Fields* section shows the register name and a brief description of each bit that affects the selected register.

3.7 Direct I²C

This tool manually reads and writes the registers of the amplifier. The *Direct I²C* window is also used to monitor the changes made to the device registers using a logging functionality. The stereo device I²C address of the EVM is 0x56, the mono device I²C address is 0x54.





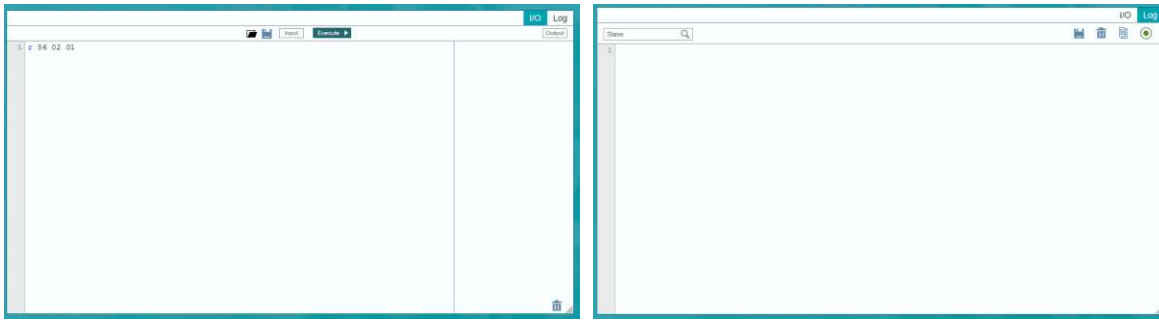



Direct I²C has two main tabs, I/O and Log, present in the top right corner of the window.



The **I/O** tab in the *I²C Monitor* has two sub sections. The Input section has the provision to enter the read or write commands scripts. Clicking the Execute button executes the commands written in the Input section. The status of the execution is displayed in the *Output* section.

The **Log** tab in the *I²C Monitor* displays the I²C command history, if the record option is enabled. The log tab has different options:

-  **Search:** search for a particular command
-  **Save to a file:** saves the log as a .config file to the PC
-  **Delete Output:** clears the log history
-  **Copy to a Clipboard:** copies the log text to the clipboard
-  **Start Recording:** starts recording the I²C transactions and displays them in the log window
-  **Stop Recording:** stops recording I²C transactions

3.8 End System Integration

The *End System Integration* feature offers a powerful tool to generate a configuration file for use with general processors and a method to debug the device in the end system.

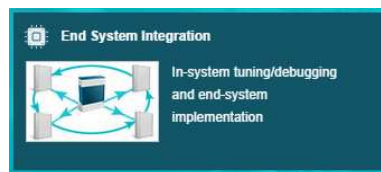

The *End System Integration* window has three main options for the customer (1) *Dump Current State into a Header file*, (2) *In-System Debugging*, and (3) *In-System Tuning*.

What would you like to do?

- Dump Current State into a Header File**
Choose this option to download the code to a header file. This generated file will contain the register addresses and the corresponding values that have to be written to the device during boot up.
- In-System Debugging**
Choose this option to read or write register values in the end system. Only Register Map and Direct I2C screens will be available.
- In-System Tuning**
Choose this option to make fine adjustments in the end system.



Dump Current State into a Header File

This feature allows generation of a configuration file for the evaluated device according to the features evaluated and configured with PPC3. Different options are available for file generation, including the format (.h, .cfg, .mtk), sample rate, device address, and so forth. The generated file is saved in the PC or can be sent to the output window that appears in the window. Take into account that the register configuration is generated from the device that is selected (Mono or Stereo).

Summary

Choose the settings with which to create header/cfg file.

Sample Rate: End System I2C Address:

Destination: Dump File:

Format: Burst:

Output

Use the tuning snapshots feature to save several different operation modes for the device in the end-system. In order to achieve this, first select the desired snapshot, then go to the *End System Integration* window and generate the configuration file.

In-System Debugging

This tool helps debug the device when integrated in the end-system. This is possible by connecting the I²C signals of the end-system device to the SCL, SDA, and GND test points of PPCMB. Limited features of the TAS5733L application are available in this mode. Disconnect from *System Debug Mode* by clicking on the *Disconnect* button on the lower left corner of the window.

In-System Debugging

Choose this option to read or write register values in the end system. Only Register Map and Direct I2C screens will be available.

Stereo Device I2C Address: Mono Device I2C Address:

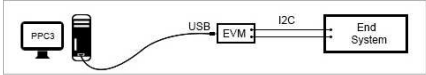

Connect the End System I2C bus to the SDA, SCL and GND test points on the motherboard.
NOTE: Revision F or newer of PUREPATH-CMBEVM allows USB power and removing the Target EVM from the motherboard

In-System Tuning

Once the device is integrated in the end application, make fine tuning adjustments to the audio processing with *In-System Tuning*. As with *In-System Debugging*, this is done by connecting I²C signals from PPCMB to the end-system amplifier. Audio processing features are available in this mode, allowing the option to fine tune the AGL, equalizers, and mixing block in the end system.

In-System Tuning

Choose this option to make fine adjustments in the end system.

Sample Rate:

Stereo Device I2C Address: Mono Device I2C Address:



Connect the End System I2C bus to the SDA, SCL and GND test points on the motherboard.
NOTE: Revision F or newer of PUREPATH-CMBEVM allows USB power and removing the Target EVM from the motherboard

4 Board Layout, Bill of Materials, and Schematic

This section includes recommendations, the EVM board layouts, bill of materials, and schematics.

The evaluation module has the stereo device populated in the upper section of the board, while the mono device is located on the lower part of the board. The connector for the power supply is located between both amplifiers. The connector that interconnects the evaluation module with the PPCMB is located in the left side of the board on the bottom face. The EVM features three connectors at the right side of the board used for the connection of the speakers and loads that are used together with the EVM. These connectors correspond to left and right channel of the stereo device and the single output of the mono device. The board has two standoffs located on each corner of the right side, allowing structural stability when connected to the controller board.

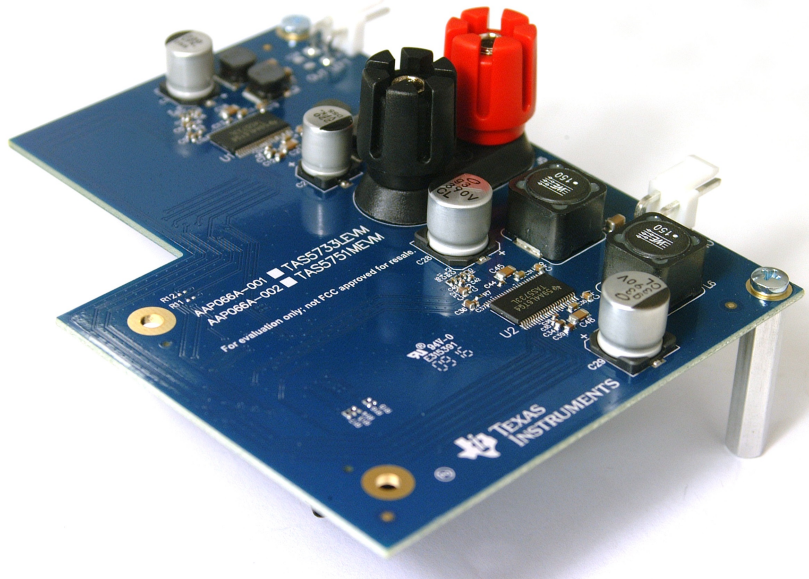

Figure 9. TAS5733LEVM

All the basic components required by the amplifier are located in the top of the board. The output filters are located on the right side of each amplifier, keeping the distance between the inductor and capacitor as short as possible. Each amplifier has a 0.1- μ F decoupling capacitor populated close to the device as well as bulk capacitors close to each PVDD pin connection. The design has wide open areas at the top and bottom part of the amplifier to increase the thermal dissipation of the amplifier.

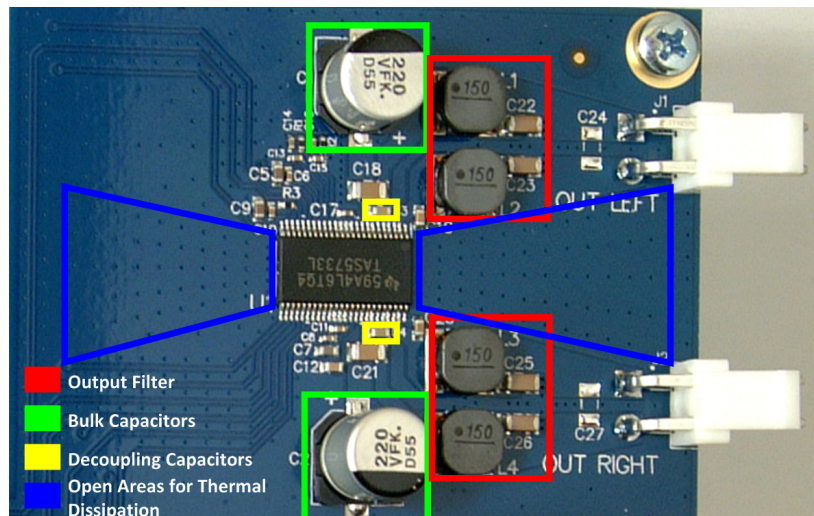

Figure 10. TAS5733L Layout

The bottom layer of the board is designed to have a clear path that is used as a heat escape from the device. RC-snubber circuits are not generally required in properly-designed 2-layer or 4-layer designs. However, in systems where capacitors for PVDD or LC filter placement is compromised, the snubber circuit is used to slow down the output square waves coming from the IC speaker outputs. A snubber circuit for each output is featured in the evaluation module to showcase their recommended position, if required for an end-system. The circuits are positioned so the thermal flow of the device has a radial clear path out of the board.

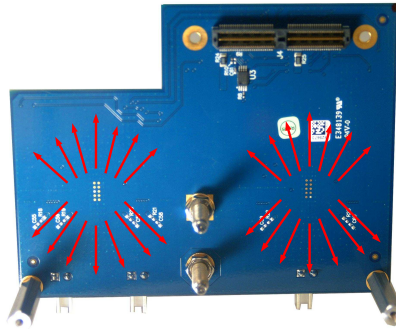

Figure 11. Bottom Layer Thermal Flow

By default, the output filter of the stereo device is configured in BD mode. The user is able to evaluate the devices in AD mode by populating the optional AD capacitors (C24, C27, and C51) in the evaluation module. The I²C address of the devices can be changed as well, if required. By default, the stereo device has an address of 0x56 and the mono device address is 0x54. Resistors R13, R14, R15, and R16 determine the address of each amplifier. Refer to the [schematic](#) of the evaluation module for more information.

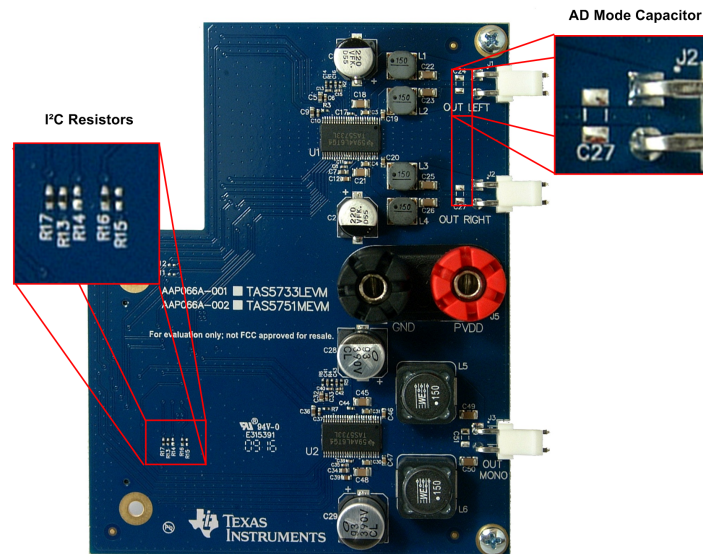

Figure 12. TAS5733LEVM Optional Features

The evaluation module is a four-layer board designed to enhance the thermal performance and robustness of the design. The second layer is used as ground plane, while the third layer contains the power planes that distribute the supply voltages through the board.

TI recommends following the layout of this EVM as close as possible to get the same performance obtained during the evaluation of the device. Any design variation can be supported by TI through schematic and layout review, as in the case of a different layer number, filter option, and component location, or if performance issues are present in the end-design. Join the [audio amplifier discussion forum](#) at e2e.ti.com for additional design assistance.

4.1 TAS5733LEVM Board Layout

Figure 13 through Figure 18 show the PCB layouts.

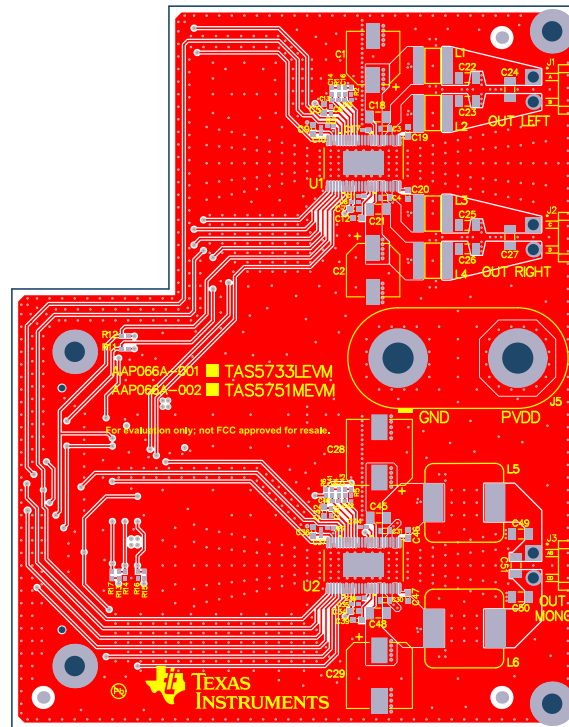

Figure 13. TAS5733LEVM Top Composite

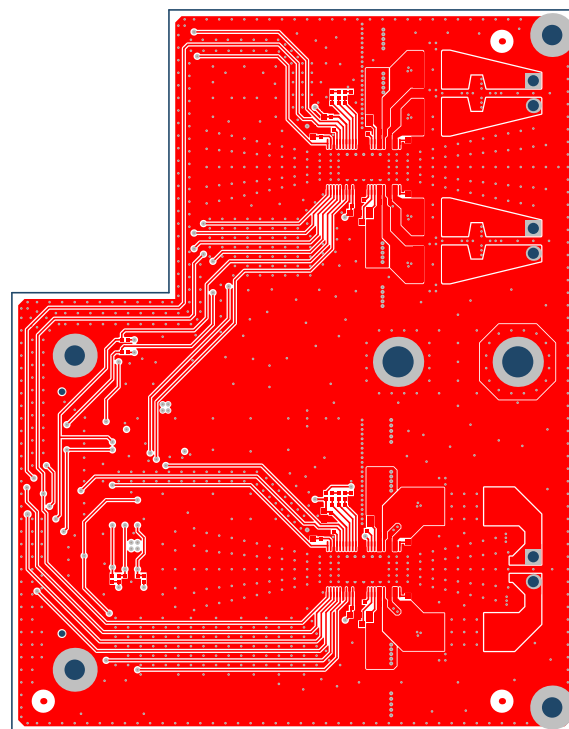

Figure 14. TAS5733LEVM Top Layer

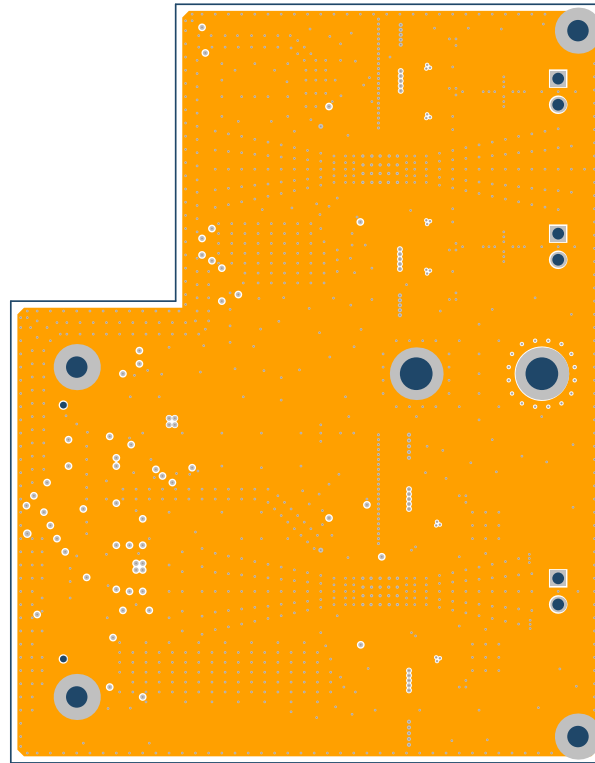

Figure 15. TAS5733LEVM Ground Layer

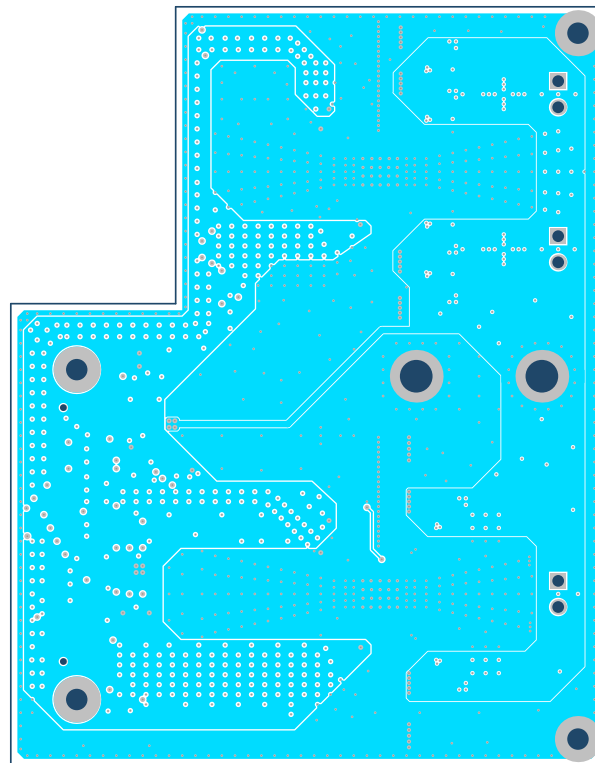

Figure 16. TAS5733LEVM Power Layer

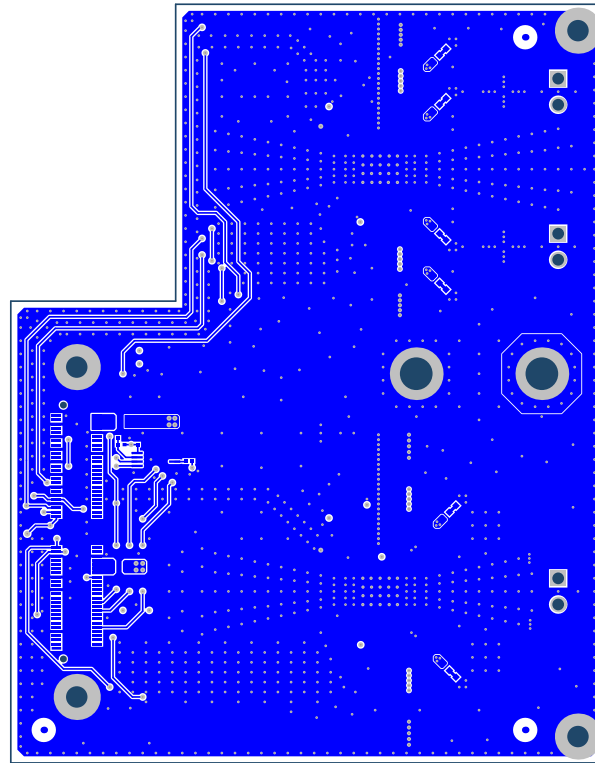

Figure 17. TAS5733LEVM Bottom Layer

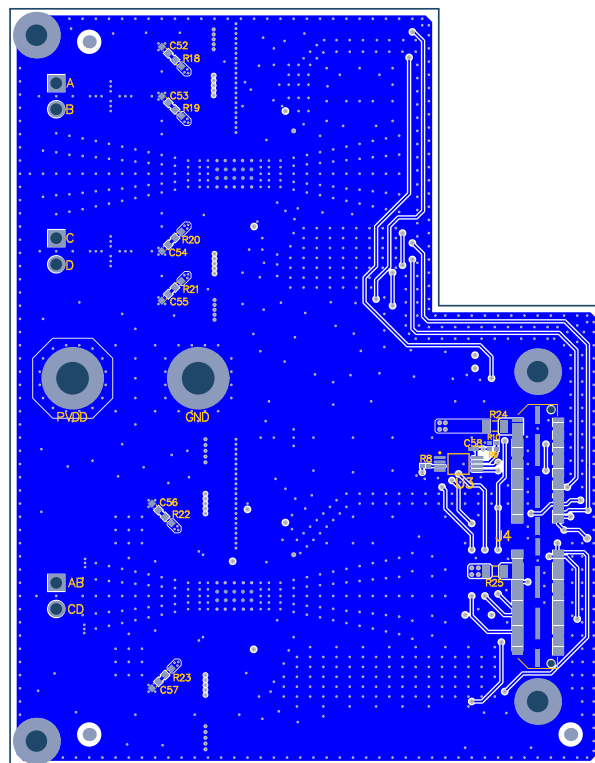

Figure 18. TAS5733LEVM Bottom Composite

4.2 Bill of Material

Table 3 lists the TAS5733LEVM BOM.

Table 3. TAS5733LEVM Bill of Materials

Item #	Designator	Qty	Value	Part Number	Manufacturer	Description	Package Reference
1	!PCB1	1		AAP066	Any	Printed Circuit Board	
2	C1, C2	2	220uF	EEE-FK1V221P	Panasonic	CAP, AL, 220 µF, 35 V, +/- 20%, 0.16 ohm, SMD	SMT Radial F
3	C3, C4, C30, C31	4	0.1uF	GCM188R71H104KA57D	Murata	CAP, CERM, 0.1 µF, 50 V, +/- 10%, X7R, 0603	0603
4	C5, C7, C9, C32, C34, C36	6	4.7uF	CGB3B1X5R1A475K055AC	TDK	CAP, CERM, 4.7 µF, 10 V, +/- 10%, X5R, 0603	0603
5	C6, C8, C10, C11, C33, C35, C37, C38	8	0.1uF	C1005X7R1H104M	TDK	CAP, CERM, 0.1 µF, 50 V, +/- 20%, X7R, 0402	0402
6	C12, C39	2	1uF	GRM188R71E105KA12D	Murata	CAP, CERM, 1 µF, 25 V, +/- 10%, X7R, 0603	0603
7	C13, C15, C40, C42	4	4700pF	GRM155R61H472KA01D	Murata	CAP, CERM, 4700 pF, 50 V, +/- 10%, X5R, 0402	0402
8	C14, C16, C41, C43	4	0.047uF	GRM155R71C473KA01D	Murata	CAP, CERM, 0.047 µF, 16 V, +/- 10%, X7R, 0402	0402
9	C17, C44	2	2200pF	GRM155R71E222KA01D	Murata	CAP, CERM, 2200 pF, 25 V, +/- 10%, X7R, 0402	0402
10	C18, C21, C45, C48	4	0.01uF	CC1206KRX7R9BB103	Yageo America	CAP, CERM, 0.01 µF, 50 V, +/- 10%, X7R, 1206	1206
11	C19, C20, C46, C47	4	0.01uF	GRM188R71H103KA01D	Murata	CAP, CERM, 0.01 µF, 50 V, +/- 10%, X7R, 0603	0603
12	C22, C23, C25, C26, C49, C50	6	0.68uF	GRM31MR71H684KA88L	Murata	CAP, CERM, 0.68 µF, 50 V, +/- 10%, X7R, 1206	1206
13	C28, C29	2	390uF	UCL1V391MNL1GS	Nichicon	CAP, AL, 390 µF, 35 V, +/- 20%, 0.08 ohm, SMD	10x10
14	C58	1	0.1uF	C1005X7R1H104K050BB	TDK	CAP, CERM, 0.1uF, 50V, +/-10%, X7R, 0402	0402
15	H1, H2	2		MPMS 003 0005 PH	B&F Fastener Supply	MACHINE SCREW PAN PHILLIPS M3 5mm	Screw M3 Phillips head
16	H3, H4	2		R30-1003002	Harwin	Standoff, HexBrass M3, 30 mm	Spacer M3, 30mm
17	J1, J2, J3	3		B2PS-VH(LF)(SN)	JST Manufacturing	Header (friction lock), 3.96mm, 2x1, Tin, R/A, TH	Header, 2x1, 3.96mm, R/A
18	J4	1		QTS-050-01-F-D-A	Samtec	Connector, 100 Pos. 0.635mm, SMT	Connector, 1575x235x280 mil
19	J5	1		6883	Pomona Electronics	Dual Binding Posts with Base, 2x1, TH	Dual Binding Posts with Base, 2x1, TH
20	L1, L2, L3, L4	4	15uH	1255AY-150M=P3	Murata	Inductor, Shielded, 15 µH, 3 A, 0.063 ohm, SMD	6.3x4.5x6.3mm
21	L5, L6	2	15uH	7447709150	Würth Elektronik	Inductor, Shielded Drum Core, Ferrite, 15 µH, 6.5 A, 0.02075 ohm, SMD	WE-PD-XXL
22	R1, R2, R4, R5	4	470	ERJ-2RKF4700X	Panasonic	RES, 470, 1%, 0.1 W, 0402	0402
23	R3, R7	2	18.0k	CRCW040218K0FKED	Vishay-Dale	RES, 18.0 k, 1%, 0.063 W, 0402	0402
24	R6, R13, R16, R17	4	47k	CRCW040247K0JNED	Vishay-Dale	RES, 47 k, 5%, 0.063 W, 0402	0402
25	R8, R10	2	10.0k	CRCW040210K0FKED	Vishay-Dale	RES, 10.0 k, 1%, 0.063 W, 0402	0402
26	R24, R25	2	0	CRCW12060000Z0EA	Vishay-Dale	RES, 0, 5%, 0.25 W, 1206	1206
27	U1, U2	2		TAS5733LDCA	Texas Instruments	Digital Audio Power Amplifier with EQ and AGL, DCA0048B	DCA0048B
28	U3	1		24LC512-I/ST	Microchip	EEPROM, 512KBIT, 400KHZ, 8TSSOP	TSSOP-8
29	C24, C27, C51	0	0.33uF	GRM319R71H334KA01D	Murata	CAP, CERM, 0.33 µF, 50 V, +/- 10%, X7R, 1206	1206

Table 3. TAS5733LEVM Bill of Materials (continued)

Item #	Designator	Qty	Value	Part Number	Manufacturer	Description	Package Reference
30	C52, C53, C54, C55, C56, C57	0	330pF	GRM1885C1H331JA01D	Murata	CAP, CERM, 330 pF, 50 V, +/- 5%, C0G/NP0, 0603	0603
31	FID1, FID2, FID3, FID4, FID5, FID6	0		N/A	N/A	Fiducial mark. There is nothing to buy or mount.	Fiducial
32	R9	0	10.0k	CRCW040210K0FKED	Vishay-Dale	RES, 10.0 k, 1%, 0.063 W, 0402	0402
33	R11, R12	0	2.00k	CRCW04022K00FKED	Vishay-Dale	RES, 2.00 k, 1%, 0.063 W, 0402	0402
34	R14, R15	0	47k	CRCW040247K0JNED	Vishay-Dale	RES, 47 k, 5%, 0.063 W, 0402	0402
35	R18, R19, R20, R21, R22, R23	0	18	CRCW060318R0JNEA	Vishay-Dale	RES, 18, 5%, 0.1 W, 0603	0603

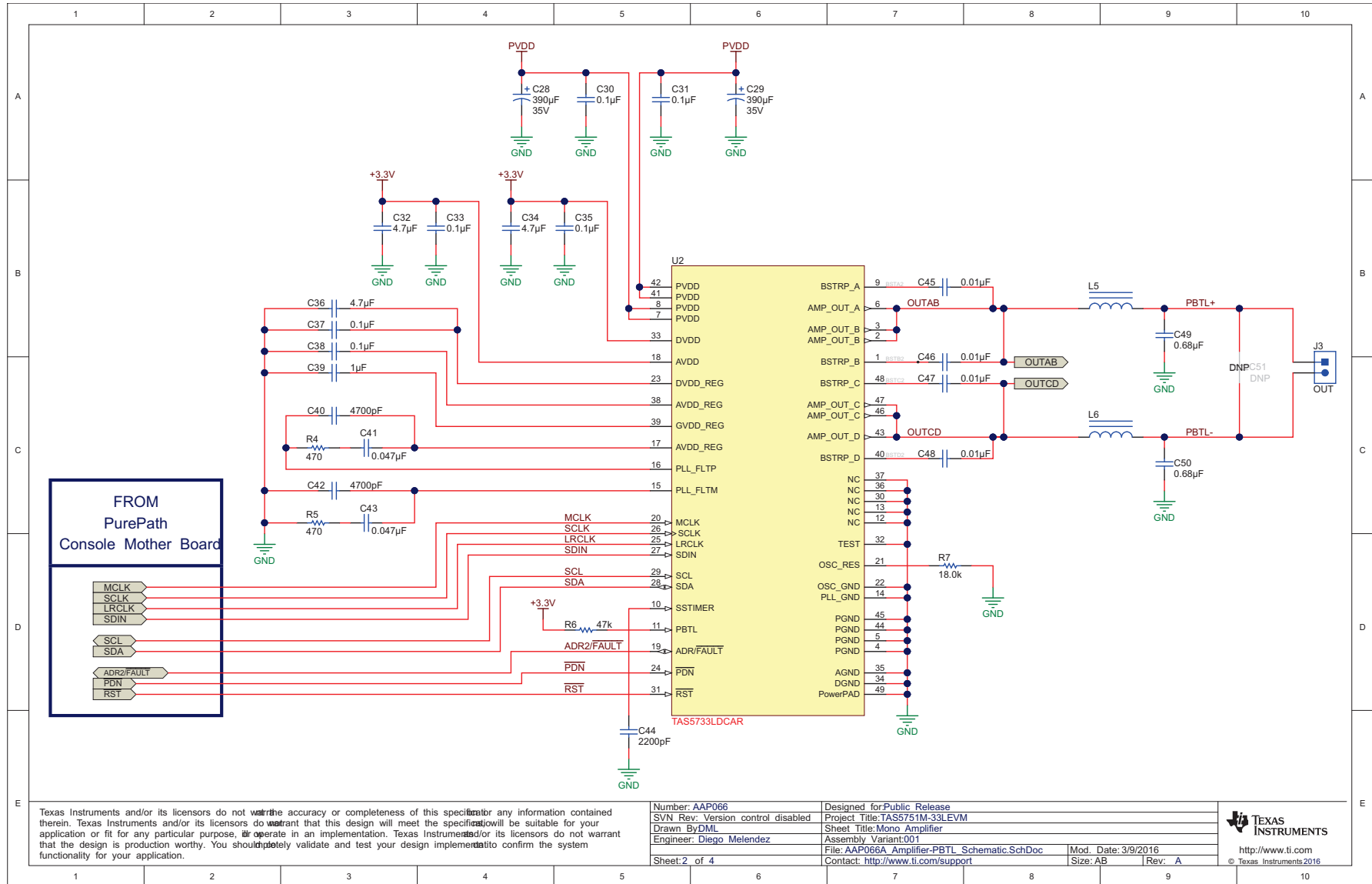

Figure 20. TAS5733LEVM Mono Device

STANDARD TERMS AND CONDITIONS FOR EVALUATION MODULES

1. *Delivery:* TI delivers TI evaluation boards, kits, or modules, including any accompanying demonstration software, components, or documentation (collectively, an "EVM" or "EVMs") to the User ("User") in accordance with the terms and conditions set forth herein. Acceptance of the EVM is expressly subject to the following terms and conditions.
 - 1.1 EVMs are intended solely for product or software developers for use in a research and development setting to facilitate feasibility evaluation, experimentation, or scientific analysis of TI semiconductors products. EVMs have no direct function and are not finished products. EVMs shall not be directly or indirectly assembled as a part or subassembly in any finished product. For clarification, any software or software tools provided with the EVM ("Software") shall not be subject to the terms and conditions set forth herein but rather shall be subject to the applicable terms and conditions that accompany such Software
 - 1.2 EVMs are not intended for consumer or household use. EVMs may not be sold, sublicensed, leased, rented, loaned, assigned, or otherwise distributed for commercial purposes by Users, in whole or in part, or used in any finished product or production system.
2. *Limited Warranty and Related Remedies/Disclaimers:*
 - 2.1 These terms and conditions do not apply to Software. The warranty, if any, for Software is covered in the applicable Software License Agreement.
 - 2.2 TI warrants that the TI EVM will conform to TI's published specifications for ninety (90) days after the date TI delivers such EVM to User. Notwithstanding the foregoing, TI shall not be liable for any defects that are caused by neglect, misuse or mistreatment by an entity other than TI, including improper installation or testing, or for any EVMs that have been altered or modified in any way by an entity other than TI. Moreover, TI shall not be liable for any defects that result from User's design, specifications or instructions for such EVMs. Testing and other quality control techniques are used to the extent TI deems necessary or as mandated by government requirements. TI does not test all parameters of each EVM.
 - 2.3 If any EVM fails to conform to the warranty set forth above, TI's sole liability shall be at its option to repair or replace such EVM, or credit User's account for such EVM. TI's liability under this warranty shall be limited to EVMs that are returned during the warranty period to the address designated by TI and that are determined by TI not to conform to such warranty. If TI elects to repair or replace such EVM, TI shall have a reasonable time to repair such EVM or provide replacements. Repaired EVMs shall be warranted for the remainder of the original warranty period. Replaced EVMs shall be warranted for a new full ninety (90) day warranty period.
3. *Regulatory Notices:*
 - 3.1 *United States*
 - 3.1.1 *Notice applicable to EVMs not FCC-Approved:*

This kit is designed to allow product developers to evaluate electronic components, circuitry, or software associated with the kit to determine whether to incorporate such items in a finished product and software developers to write software applications for use with the end product. This kit is not a finished product and when assembled may not be resold or otherwise marketed unless all required FCC equipment authorizations are first obtained. Operation is subject to the condition that this product not cause harmful interference to licensed radio stations and that this product accept harmful interference. Unless the assembled kit is designed to operate under part 15, part 18 or part 95 of this chapter, the operator of the kit must operate under the authority of an FCC license holder or must secure an experimental authorization under part 5 of this chapter.
 - 3.1.2 *For EVMs annotated as FCC – FEDERAL COMMUNICATIONS COMMISSION Part 15 Compliant:*

CAUTION

This device complies with part 15 of the FCC Rules. Operation is subject to the following two conditions: (1) This device may not cause harmful interference, and (2) this device must accept any interference received, including interference that may cause undesired operation.

Changes or modifications not expressly approved by the party responsible for compliance could void the user's authority to operate the equipment.

FCC Interference Statement for Class A EVM devices

NOTE: This equipment has been tested and found to comply with the limits for a Class A digital device, pursuant to part 15 of the FCC Rules. These limits are designed to provide reasonable protection against harmful interference when the equipment is operated in a commercial environment. This equipment generates, uses, and can radiate radio frequency energy and, if not installed and used in accordance with the instruction manual, may cause harmful interference to radio communications. Operation of this equipment in a residential area is likely to cause harmful interference in which case the user will be required to correct the interference at his own expense.

FCC Interference Statement for Class B EVM devices

NOTE: This equipment has been tested and found to comply with the limits for a Class B digital device, pursuant to part 15 of the FCC Rules. These limits are designed to provide reasonable protection against harmful interference in a residential installation. This equipment generates, uses and can radiate radio frequency energy and, if not installed and used in accordance with the instructions, may cause harmful interference to radio communications. However, there is no guarantee that interference will not occur in a particular installation. If this equipment does cause harmful interference to radio or television reception, which can be determined by turning the equipment off and on, the user is encouraged to try to correct the interference by one or more of the following measures:

- Reorient or relocate the receiving antenna.
- Increase the separation between the equipment and receiver.
- Connect the equipment into an outlet on a circuit different from that to which the receiver is connected.
- Consult the dealer or an experienced radio/TV technician for help.

3.2 Canada

3.2.1 For EVMs issued with an Industry Canada Certificate of Conformance to RSS-210

Concerning EVMs Including Radio Transmitters:

This device complies with Industry Canada license-exempt RSS standard(s). Operation is subject to the following two conditions: (1) this device may not cause interference, and (2) this device must accept any interference, including interference that may cause undesired operation of the device.

Concernant les EVMs avec appareils radio:

Le présent appareil est conforme aux CNR d'Industrie Canada applicables aux appareils radio exempts de licence. L'exploitation est autorisée aux deux conditions suivantes: (1) l'appareil ne doit pas produire de brouillage, et (2) l'utilisateur de l'appareil doit accepter tout brouillage radioélectrique subi, même si le brouillage est susceptible d'en compromettre le fonctionnement.

Concerning EVMs Including Detachable Antennas:

Under Industry Canada regulations, this radio transmitter may only operate using an antenna of a type and maximum (or lesser) gain approved for the transmitter by Industry Canada. To reduce potential radio interference to other users, the antenna type and its gain should be so chosen that the equivalent isotropically radiated power (e.i.r.p.) is not more than that necessary for successful communication. This radio transmitter has been approved by Industry Canada to operate with the antenna types listed in the user guide with the maximum permissible gain and required antenna impedance for each antenna type indicated. Antenna types not included in this list, having a gain greater than the maximum gain indicated for that type, are strictly prohibited for use with this device.

Concernant les EVMs avec antennes détachables

Conformément à la réglementation d'Industrie Canada, le présent émetteur radio peut fonctionner avec une antenne d'un type et d'un gain maximal (ou inférieur) approuvé pour l'émetteur par Industrie Canada. Dans le but de réduire les risques de brouillage radioélectrique à l'intention des autres utilisateurs, il faut choisir le type d'antenne et son gain de sorte que la puissance isotrope rayonnée équivalente (p.i.r.e.) ne dépasse pas l'intensité nécessaire à l'établissement d'une communication satisfaisante. Le présent émetteur radio a été approuvé par Industrie Canada pour fonctionner avec les types d'antenne énumérés dans le manuel d'usage et ayant un gain admissible maximal et l'impédance requise pour chaque type d'antenne. Les types d'antenne non inclus dans cette liste, ou dont le gain est supérieur au gain maximal indiqué, sont strictement interdits pour l'exploitation de l'émetteur.

3.3 Japan

3.3.1 *Notice for EVMs delivered in Japan:* Please see http://www.tij.co.jp/lstds/ti_ja/general/eStore/notice_01.page 日本国内に輸入される評価用キット、ボードについては、次のところをご覧ください。
http://www.tij.co.jp/lstds/ti_ja/general/eStore/notice_01.page

3.3.2 *Notice for Users of EVMs Considered "Radio Frequency Products" in Japan:* EVMs entering Japan may not be certified by TI as conforming to Technical Regulations of Radio Law of Japan.

If User uses EVMs in Japan, not certified to Technical Regulations of Radio Law of Japan, User is required by Radio Law of Japan to follow the instructions below with respect to EVMs:

1. Use EVMs in a shielded room or any other test facility as defined in the notification #173 issued by Ministry of Internal Affairs and Communications on March 28, 2006, based on Sub-section 1.1 of Article 6 of the Ministry's Rule for Enforcement of Radio Law of Japan,
2. Use EVMs only after User obtains the license of Test Radio Station as provided in Radio Law of Japan with respect to EVMs, or
3. Use of EVMs only after User obtains the Technical Regulations Conformity Certification as provided in Radio Law of Japan with respect to EVMs. Also, do not transfer EVMs, unless User gives the same notice above to the transferee. Please note that if User does not follow the instructions above, User will be subject to penalties of Radio Law of Japan.

【無線電波を送信する製品の開発キットをお使いになる際の注意事項】 開発キットの中には技術基準適合証明を受けていないものがあります。技術適合証明を受けていないものご使用に際しては、電波法遵守のため、以下のいずれかの措置を取っていただく必要がありますのでご注意ください。

1. 電波法施行規則第6条第1項第1号に基づく平成18年3月28日総務省告示第173号で定められた電波暗室等の試験設備でご使用いただく。
2. 実験局の免許を取得後ご使用いただく。
3. 技術基準適合証明を取得後ご使用いただく。

なお、本製品は、上記の「ご使用にあたっての注意」を譲渡先、移転先に通知しない限り、譲渡、移転できないものとします。

上記を遵守頂けない場合は、電波法の罰則が適用される可能性があることをご留意ください。日本テキサス・インスツルメンツ株式会社
東京都新宿区西新宿 6 丁目 2 4 番 1 号
西新宿三井ビル

3.3.3 *Notice for EVMs for Power Line Communication:* Please see http://www.tij.co.jp/llds/ti_ja/general/eStore/notice_02.page
電力線搬送波通信についての開発キットをお使いになる際の注意事項については、次のところをご覧ください。http://www.tij.co.jp/llds/ti_ja/general/eStore/notice_02.page

4 *EVM Use Restrictions and Warnings:*

4.1 EVMS ARE NOT FOR USE IN FUNCTIONAL SAFETY AND/OR SAFETY CRITICAL EVALUATIONS, INCLUDING BUT NOT LIMITED TO EVALUATIONS OF LIFE SUPPORT APPLICATIONS.

4.2 User must read and apply the user guide and other available documentation provided by TI regarding the EVM prior to handling or using the EVM, including without limitation any warning or restriction notices. The notices contain important safety information related to, for example, temperatures and voltages.

4.3 *Safety-Related Warnings and Restrictions:*

4.3.1 User shall operate the EVM within TI's recommended specifications and environmental considerations stated in the user guide, other available documentation provided by TI, and any other applicable requirements and employ reasonable and customary safeguards. Exceeding the specified performance ratings and specifications (including but not limited to input and output voltage, current, power, and environmental ranges) for the EVM may cause personal injury or death, or property damage. If there are questions concerning performance ratings and specifications, User should contact a TI field representative prior to connecting interface electronics including input power and intended loads. Any loads applied outside of the specified output range may also result in unintended and/or inaccurate operation and/or possible permanent damage to the EVM and/or interface electronics. Please consult the EVM user guide prior to connecting any load to the EVM output. If there is uncertainty as to the load specification, please contact a TI field representative. During normal operation, even with the inputs and outputs kept within the specified allowable ranges, some circuit components may have elevated case temperatures. These components include but are not limited to linear regulators, switching transistors, pass transistors, current sense resistors, and heat sinks, which can be identified using the information in the associated documentation. When working with the EVM, please be aware that the EVM may become very warm.

4.3.2 EVMs are intended solely for use by technically qualified, professional electronics experts who are familiar with the dangers and application risks associated with handling electrical mechanical components, systems, and subsystems. User assumes all responsibility and liability for proper and safe handling and use of the EVM by User or its employees, affiliates, contractors or designees. User assumes all responsibility and liability to ensure that any interfaces (electronic and/or mechanical) between the EVM and any human body are designed with suitable isolation and means to safely limit accessible leakage currents to minimize the risk of electrical shock hazard. User assumes all responsibility and liability for any improper or unsafe handling or use of the EVM by User or its employees, affiliates, contractors or designees.

4.4 User assumes all responsibility and liability to determine whether the EVM is subject to any applicable international, federal, state, or local laws and regulations related to User's handling and use of the EVM and, if applicable, User assumes all responsibility and liability for compliance in all respects with such laws and regulations. User assumes all responsibility and liability for proper disposal and recycling of the EVM consistent with all applicable international, federal, state, and local requirements.

5. *Accuracy of Information:* To the extent TI provides information on the availability and function of EVMs, TI attempts to be as accurate as possible. However, TI does not warrant the accuracy of EVM descriptions, EVM availability or other information on its websites as accurate, complete, reliable, current, or error-free.

6. *Disclaimers:*
- 6.1 EXCEPT AS SET FORTH ABOVE, EVMS AND ANY WRITTEN DESIGN MATERIALS PROVIDED WITH THE EVM (AND THE DESIGN OF THE EVM ITSELF) ARE PROVIDED "AS IS" AND "WITH ALL FAULTS." TI DISCLAIMS ALL OTHER WARRANTIES, EXPRESS OR IMPLIED, REGARDING SUCH ITEMS, INCLUDING BUT NOT LIMITED TO ANY IMPLIED WARRANTIES OF MERCHANTABILITY OR FITNESS FOR A PARTICULAR PURPOSE OR NON-INFRINGEMENT OF ANY THIRD PARTY PATENTS, COPYRIGHTS, TRADE SECRETS OR OTHER INTELLECTUAL PROPERTY RIGHTS.
- 6.2 EXCEPT FOR THE LIMITED RIGHT TO USE THE EVM SET FORTH HEREIN, NOTHING IN THESE TERMS AND CONDITIONS SHALL BE CONSTRUED AS GRANTING OR CONFERRING ANY RIGHTS BY LICENSE, PATENT, OR ANY OTHER INDUSTRIAL OR INTELLECTUAL PROPERTY RIGHT OF TI, ITS SUPPLIERS/LICENSORS OR ANY OTHER THIRD PARTY, TO USE THE EVM IN ANY FINISHED END-USER OR READY-TO-USE FINAL PRODUCT, OR FOR ANY INVENTION, DISCOVERY OR IMPROVEMENT MADE, CONCEIVED OR ACQUIRED PRIOR TO OR AFTER DELIVERY OF THE EVM.
7. *USER'S INDEMNITY OBLIGATIONS AND REPRESENTATIONS.* USER WILL DEFEND, INDEMNIFY AND HOLD TI, ITS LICENSORS AND THEIR REPRESENTATIVES HARMLESS FROM AND AGAINST ANY AND ALL CLAIMS, DAMAGES, LOSSES, EXPENSES, COSTS AND LIABILITIES (COLLECTIVELY, "CLAIMS") ARISING OUT OF OR IN CONNECTION WITH ANY HANDLING OR USE OF THE EVM THAT IS NOT IN ACCORDANCE WITH THESE TERMS AND CONDITIONS. THIS OBLIGATION SHALL APPLY WHETHER CLAIMS ARISE UNDER STATUTE, REGULATION, OR THE LAW OF TORT, CONTRACT OR ANY OTHER LEGAL THEORY, AND EVEN IF THE EVM FAILS TO PERFORM AS DESCRIBED OR EXPECTED.
8. *Limitations on Damages and Liability:*
- 8.1 *General Limitations.* IN NO EVENT SHALL TI BE LIABLE FOR ANY SPECIAL, COLLATERAL, INDIRECT, PUNITIVE, INCIDENTAL, CONSEQUENTIAL, OR EXEMPLARY DAMAGES IN CONNECTION WITH OR ARISING OUT OF THESE TERMS AND CONDITIONS OR THE USE OF THE EVMS PROVIDED HEREUNDER, REGARDLESS OF WHETHER TI HAS BEEN ADVISED OF THE POSSIBILITY OF SUCH DAMAGES. EXCLUDED DAMAGES INCLUDE, BUT ARE NOT LIMITED TO, COST OF REMOVAL OR REINSTALLATION, ANCILLARY COSTS TO THE PROCUREMENT OF SUBSTITUTE GOODS OR SERVICES, RETESTING, OUTSIDE COMPUTER TIME, LABOR COSTS, LOSS OF GOODWILL, LOSS OF PROFITS, LOSS OF SAVINGS, LOSS OF USE, LOSS OF DATA, OR BUSINESS INTERRUPTION. NO CLAIM, SUIT OR ACTION SHALL BE BROUGHT AGAINST TI MORE THAN ONE YEAR AFTER THE RELATED CAUSE OF ACTION HAS OCCURRED.
- 8.2 *Specific Limitations.* IN NO EVENT SHALL TI'S AGGREGATE LIABILITY FROM ANY WARRANTY OR OTHER OBLIGATION ARISING OUT OF OR IN CONNECTION WITH THESE TERMS AND CONDITIONS, OR ANY USE OF ANY TI EVM PROVIDED HEREUNDER, EXCEED THE TOTAL AMOUNT PAID TO TI FOR THE PARTICULAR UNITS SOLD UNDER THESE TERMS AND CONDITIONS WITH RESPECT TO WHICH LOSSES OR DAMAGES ARE CLAIMED. THE EXISTENCE OF MORE THAN ONE CLAIM AGAINST THE PARTICULAR UNITS SOLD TO USER UNDER THESE TERMS AND CONDITIONS SHALL NOT ENLARGE OR EXTEND THIS LIMIT.
9. *Return Policy.* Except as otherwise provided, TI does not offer any refunds, returns, or exchanges. Furthermore, no return of EVM(s) will be accepted if the package has been opened and no return of the EVM(s) will be accepted if they are damaged or otherwise not in a resalable condition. If User feels it has been incorrectly charged for the EVM(s) it ordered or that delivery violates the applicable order, User should contact TI. All refunds will be made in full within thirty (30) working days from the return of the components(s), excluding any postage or packaging costs.
10. *Governing Law:* These terms and conditions shall be governed by and interpreted in accordance with the laws of the State of Texas, without reference to conflict-of-laws principles. User agrees that non-exclusive jurisdiction for any dispute arising out of or relating to these terms and conditions lies within courts located in the State of Texas and consents to venue in Dallas County, Texas. Notwithstanding the foregoing, any judgment may be enforced in any United States or foreign court, and TI may seek injunctive relief in any United States or foreign court.

Mailing Address: Texas Instruments, Post Office Box 655303, Dallas, Texas 75265
Copyright © 2015, Texas Instruments Incorporated

IMPORTANT NOTICE

Texas Instruments Incorporated and its subsidiaries (TI) reserve the right to make corrections, enhancements, improvements and other changes to its semiconductor products and services per JESD46, latest issue, and to discontinue any product or service per JESD48, latest issue. Buyers should obtain the latest relevant information before placing orders and should verify that such information is current and complete. All semiconductor products (also referred to herein as "components") are sold subject to TI's terms and conditions of sale supplied at the time of order acknowledgment.

TI warrants performance of its components to the specifications applicable at the time of sale, in accordance with the warranty in TI's terms and conditions of sale of semiconductor products. Testing and other quality control techniques are used to the extent TI deems necessary to support this warranty. Except where mandated by applicable law, testing of all parameters of each component is not necessarily performed.

TI assumes no liability for applications assistance or the design of Buyers' products. Buyers are responsible for their products and applications using TI components. To minimize the risks associated with Buyers' products and applications, Buyers should provide adequate design and operating safeguards.

TI does not warrant or represent that any license, either express or implied, is granted under any patent right, copyright, mask work right, or other intellectual property right relating to any combination, machine, or process in which TI components or services are used. Information published by TI regarding third-party products or services does not constitute a license to use such products or services or a warranty or endorsement thereof. Use of such information may require a license from a third party under the patents or other intellectual property of the third party, or a license from TI under the patents or other intellectual property of TI.

Reproduction of significant portions of TI information in TI data books or data sheets is permissible only if reproduction is without alteration and is accompanied by all associated warranties, conditions, limitations, and notices. TI is not responsible or liable for such altered documentation. Information of third parties may be subject to additional restrictions.

Resale of TI components or services with statements different from or beyond the parameters stated by TI for that component or service voids all express and any implied warranties for the associated TI component or service and is an unfair and deceptive business practice. TI is not responsible or liable for any such statements.

Buyer acknowledges and agrees that it is solely responsible for compliance with all legal, regulatory and safety-related requirements concerning its products, and any use of TI components in its applications, notwithstanding any applications-related information or support that may be provided by TI. Buyer represents and agrees that it has all the necessary expertise to create and implement safeguards which anticipate dangerous consequences of failures, monitor failures and their consequences, lessen the likelihood of failures that might cause harm and take appropriate remedial actions. Buyer will fully indemnify TI and its representatives against any damages arising out of the use of any TI components in safety-critical applications.

In some cases, TI components may be promoted specifically to facilitate safety-related applications. With such components, TI's goal is to help enable customers to design and create their own end-product solutions that meet applicable functional safety standards and requirements. Nonetheless, such components are subject to these terms.

No TI components are authorized for use in FDA Class III (or similar life-critical medical equipment) unless authorized officers of the parties have executed a special agreement specifically governing such use.

Only those TI components which TI has specifically designated as military grade or "enhanced plastic" are designed and intended for use in military/aerospace applications or environments. Buyer acknowledges and agrees that any military or aerospace use of TI components which have **not** been so designated is solely at the Buyer's risk, and that Buyer is solely responsible for compliance with all legal and regulatory requirements in connection with such use.

TI has specifically designated certain components as meeting ISO/TS16949 requirements, mainly for automotive use. In any case of use of non-designated products, TI will not be responsible for any failure to meet ISO/TS16949.

Products

Audio	www.ti.com/audio
Amplifiers	amplifier.ti.com
Data Converters	dataconverter.ti.com
DLP® Products	www.dlp.com
DSP	dsp.ti.com
Clocks and Timers	www.ti.com/clocks
Interface	interface.ti.com
Logic	logic.ti.com
Power Mgmt	power.ti.com
Microcontrollers	microcontroller.ti.com
RFID	www.ti-rfid.com
OMAP Applications Processors	www.ti.com/omap
Wireless Connectivity	www.ti.com/wirelessconnectivity

Applications

Automotive and Transportation	www.ti.com/automotive
Communications and Telecom	www.ti.com/communications
Computers and Peripherals	www.ti.com/computers
Consumer Electronics	www.ti.com/consumer-apps
Energy and Lighting	www.ti.com/energy
Industrial	www.ti.com/industrial
Medical	www.ti.com/medical
Security	www.ti.com/security
Space, Avionics and Defense	www.ti.com/space-avionics-defense
Video and Imaging	www.ti.com/video

TI E2E Community

e2e.ti.com

Looking for pricing, stock, or lifecycle information?

Click below to explore more details on WIN SOURCE:

 [View TAS5733LEVM on WIN SOURCE](#)

 [Texas Instruments](#) Information

Optimize Your Supply Chain with WIN SOURCE Solutions

-  Global Sourcing Solution
-  Obsolete Management
-  Cost Control Management
-  Shortage Management
-  Alternative Solution
-  Excess Inventory Management