



**THE DATASHEET OF  
RF058-06SP2-303030-0350**



**Pb** THIS PRODUCT MANUFACTURED WITH LEAD-FREE PROCESSING

**DESIGNED & DIMENSIONED IN MILLIMETERS [INCHES]**

DO NOT SCALE FROM THIS PRINT

RF058-XXXXX-XXXXXX-XXXX

CABLE CALLOUT  
058: RG-58 CABLE (CCA-058)

END 1 CONNECTOR  
(SEE TABLE 3, SHT 2)

END 2 CONNECTOR OR PREPARATION  
(SEE TABLE 3, SHT 2)

OVERALL ASSEMBLY LENGTH (OAL)  
XXXX (MILLIMETERS) (0100 MIN)  
(SEE NOTE 8)

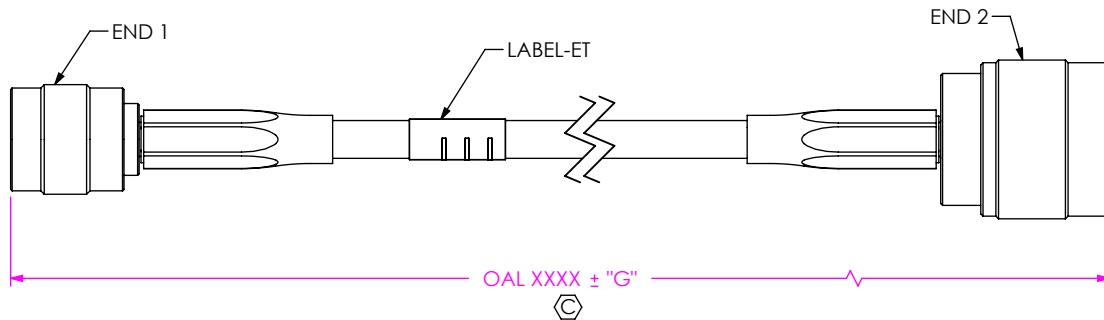

FIG 1  
RF058-05SR3-06SP2-XXXX SHOWN

TABLE 2	
OVERALL LENGTH	"G"
0100-0200 [3.92-7.87]	+3.0 [.12]/-0.0 [.00]
0200-0500 [7.87-19.69]	+5.0 [.20]/-0.0 [.00]
0500-1100 [19.69-43.30]	+10.0 [.40]/-0.0 [.00]
>1100 [43.30]	± 1%

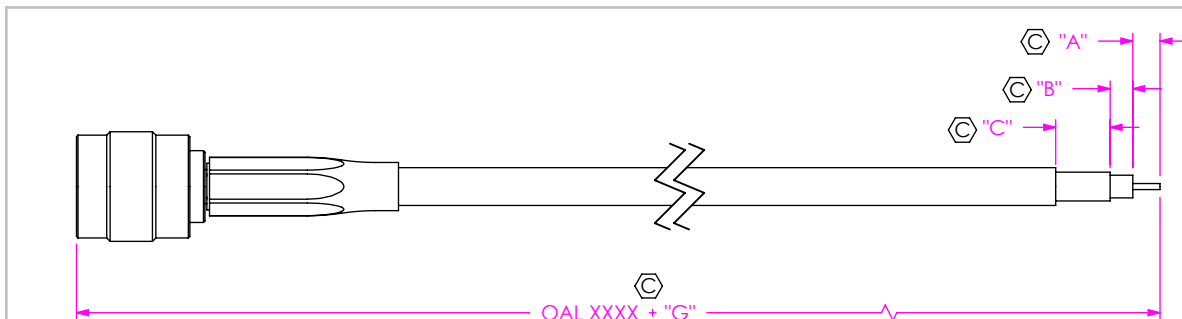

FIG 2  
RF058-05SR3-172849-XXXX SHOWN (SEE NOTE 5 & 7)

"C" (FORMAT: X.X)  
"B" (FORMAT: X.X)  
"A" (FORMAT: X.X)

DO NOT LEAVE ANY SPACE BLANK,  
EACH MUST CONTAIN A  
NUMERIC CHARACTER 0 THRU 9.

F:\DWG\MISC\MKTG\RF058-XXXXX-XXXXXX-XXXX-MKT.SLDDRW

- NOTES:
- ① (C) REPRESENTS A CRITICAL DIMENSION.
  - ② ASSEMBLY TO BE 100% TESTED FOR OPENS, SHORTS & HI-POT TESTED (PER TABLE 1, AC OR DC), THE HI-POT VOLTAGE FOR THE ASSEMBLY SHOULD BE SET TO THE END OPTION WITH THE LOWEST TEST VOLTAGE RATING.
  - AFTER FINAL ELECTRICAL TEST, LABEL EACH CABLE ASSEMBLY WITH 1 LABEL-ET.
  - FINISHED ASSEMBLIES TO BE PACKAGED PER PACKAGING STANDARD CO-RF-WI-3040-M. ASSEMBLIES WITH LOCKWASHERS, NUTS, AND GASKETS TO BE SHIPPED KITTED AS ONE ASSEMBLY PER BAG, UNASSEMBLED.
  - DIM "A", "B", AND "C" HAVE A MINIMUM VALUE OF 0.0mm & A MAXIMUM VALUE OF 9.9mm.
  - CONNECTORS TO BE ORIENTED ACCORDING TO CO-RF-WI-3048-M.
  - FOR STRIPPED AND TINNED OPTION, ONLY THE CENTER CONDUCTOR IS TINNED.
  - CABLE LENGTHS LONGER THAN 1000 MILLIMETERS ARE NOT SUPPORTED BY S.I. TEST DATA.

**UNLESS OTHERWISE SPECIFIED, DIMENSIONS ARE IN MILLIMETERS [INCHES].**  
TOLERANCES ARE:  
DECIMALS ANGLES  
.X: ±0.3 [.01] 2°  
.XX: ±0.13 [.005]  
.XXX: ±0.051 [.0020]

**MATERIAL:** DO NOT SCALE DRAWING SHEET SCALE: 2:1  
NUTS, LOCK WASHERS, SHELLS, FERRULES, CONTACTS: BRASS  
INSULATORS: PTFE  
GASKETS: SILICONE  
RINGS: STAINLESS STEEL

**PROPRIETARY NOTE**  
THIS DOCUMENT CONTAINS CONFIDENTIAL AND PROPRIETARY INFORMATION AND ALL DESIGN, MANUFACTURING, REPRODUCTION, USE, PATENT RIGHTS AND SALES RIGHTS ARE EXPRESSLY RESERVED BY SAMTEC, INC. THIS DOCUMENT SHALL NOT BE DISCLOSED, IN WHOLE OR PART, TO ANY UNAUTHORIZED PERSON OR ENTITY NOR REPRODUCED, TRANSFERRED OR INCORPORATED IN ANY OTHER PROJECT IN ANY MANNER WITHOUT THE EXPRESS WRITTEN CONSENT OF SAMTEC, INC.

520 PARK EAST BLVD, NEW ALBANY, IN 47150  
PHONE: 812-944-6733 FAX: 812-948-5047  
e-Mail info@SAMTEC.com code 55322

DESCRIPTION: RF058 CABLE ASSEMBLY

DWG. NO. RF058-XXXXX-XXXXXX-XXXX

BY: TIM P. 5/6/2005 SHEET 1 OF 7

TABLE 3

END 2 OPTION	SERIES	GENDER	CONFIGURATION	PLATING			FIGURE
				CENTER CONTACT	OUTER CONTACT	OTHER COMPONENTS	
-05SR3	TNC	REVERSE POLARITY PLUG	STRAIGHT	10µ" GOLD	100µ" NICKEL	100µ" NICKEL	SHT 3, FIG 3
-06SP2	NTPE	PLUG	STRAIGHT	30µ" GOLD	100µ" NICKEL	100µ" NICKEL	SHT 3, FIG 4
-06SP3	NTPE	PLUG	STRAIGHT	10µ" GOLD	100µ" NICKEL	100µ" NICKEL	
-01BJ1	SMA	JACK	STRAIGHT BULKHEAD	30µ" GOLD	3µ" GOLD	3µ" GOLD	SHT 4, FIG 5
-01SB1	SMA	JACK	SEALED STRAIGHT BULKHEAD	30µ" GOLD	3µ" GOLD	3µ" GOLD	SHT 4, FIG 6
-01SP1	SMA	PLUG	STRAIGHT	30µ" GOLD	3µ" GOLD	3µ" GOLD	SHT 5, FIG 7
*-SING	SINGLE ENDED	-	-	-	-	-	-
*-XXXXXX	STRIPPED & TINNED	-	-	-	-	-	SHT 1, FIG 2

\* = END OPTION ONLY

TABLE 1

END OPTION	SUBTRACTOR	STRIP DIMENSIONS			HEAT SHRINK TUBE	HI POT		
		"Y"	"A"	"D"		"E"	"F"	"DC"
-05SR3		9.2 [0.36]	5.3 [0.21]	8.7 [0.34]	16.8 [0.66]	20.00 [0.787]	1000	1400
-06SP2	15.3 [0.60]	3.6 [0.14]	6.6 [0.26]	13.8 [0.54]	25.00 [0.984]	1000	1400	
-06SP3								
-01BJ1		8.7 [0.34]	2.5 [0.10]	6.4 [0.25]	15.5 [0.61]	20.00 [0.787]	1000	1000
-01SB1		8.7 [0.34]	2.5 [0.10]	6.4 [0.25]	15.5 [0.61]	20.00 [0.787]	1000	1000
-01SP1		5.2 [0.20]	3.0 [0.12]	4.0 [0.16]	13.0 [0.51]	20.00 [0.787]	1000	1000
*-SING	0.0 [0.00]	-	-	-	N/A	1000	N/A	
*-XXXXXX	0.0 [0.00]	"A"	"A" + "B"	"A" + "B" + "C"	N/A	1000	N/A	

\* = END 2 OPTION ONLY

**PROPRIETARY NOTE**  
 THIS DOCUMENT CONTAINS CONFIDENTIAL AND PROPRIETARY INFORMATION AND ALL DESIGN, MANUFACTURING, REPRODUCTION, USE, PATENT RIGHTS AND SALES RIGHTS ARE EXPRESSLY RESERVED BY SAMTEC, INC. THIS DOCUMENT SHALL NOT BE DISCLOSED, IN WHOLE OR PART, TO ANY UNAUTHORIZED PERSON OR ENTITY NOR REPRODUCED, TRANSFERRED OR INCORPORATED IN ANY OTHER PROJECT IN ANY MANNER WITHOUT THE EXPRESS WRITTEN CONSENT OF SAMTEC, INC.

DO NOT SCALE DRAWING

SHEET SCALE: 10:1



520 PARK EAST BLVD, NEW ALBANY, IN 47150  
 PHONE: 812-944-6733 FAX: 812-948-5047  
 e-Mail info@SAMTEC.com code 55322

DESCRIPTION: RF058 CABLE ASSEMBLY  
 DWG. NO. RF058-XXXXX-XXXXXX-XXXX  
 BY: TIM P. 5/6/2005 SHEET 2 OF 7

FIG 3  
-05SR3 SHOWN

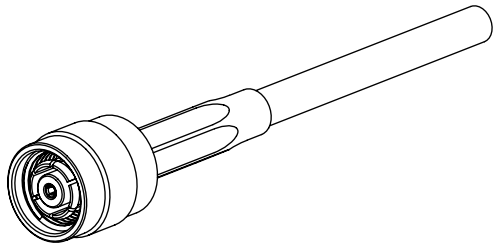
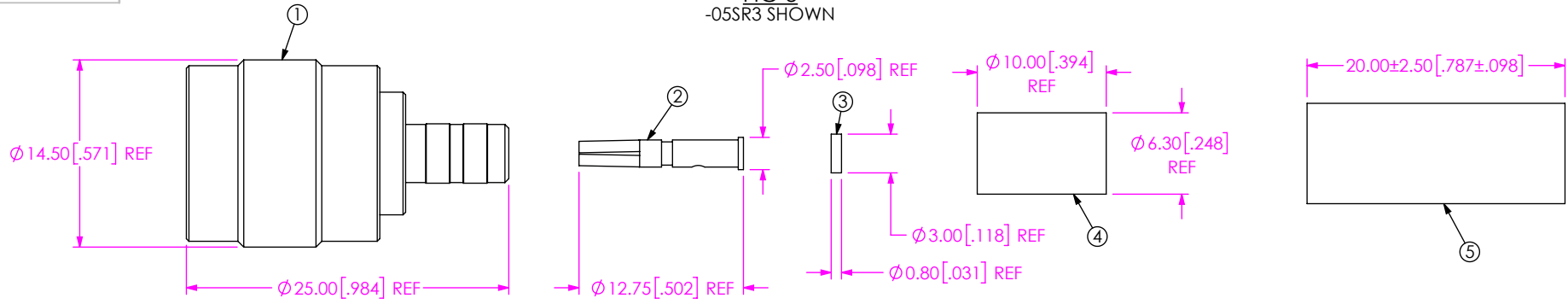

BOM		
ITEM	COMPONENT	-05SR3
1	SUB ASSEMBLY	SUB-TNC-P-C-N-SR-C10
2	SOCKET	TNC-SKT-002-G
3	INSULATOR	TNC-INS-002
4	FERRULE	TNC-FER-003-N
5	HEAT SHRINK TUBE	HST-0.250-02-BLK

FIG 4  
-06SPX SHOWN

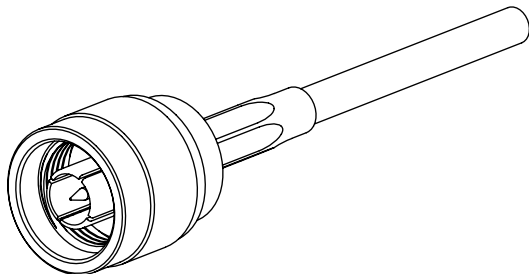
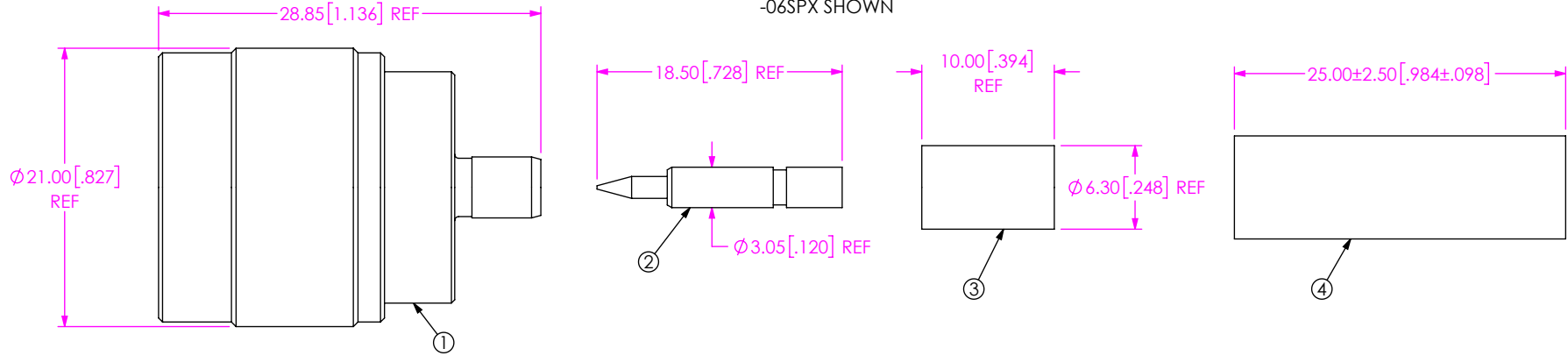

BOM			
ITEM	COMPONENT	-06SP2	-06SP3
1	SUB ASSEMBLY	SUB-NTPE-P-C-N-ST-C10	
2	PIN	NTPE-PIN-002-H	NTPE-PIN-002-G
3	FERRULE	TNC-FER-003-N	
4	HEAT SHRINK TUBE	HST-0.250-02-BLK	

**PROPRIETARY NOTE**  
 THIS DOCUMENT CONTAINS CONFIDENTIAL AND PROPRIETARY INFORMATION AND ALL DESIGN, MANUFACTURING, REPRODUCTION, USE, PATENT RIGHTS AND SALES RIGHTS ARE EXPRESSLY RESERVED BY SAMTEC, INC. THIS DOCUMENT SHALL NOT BE DISCLOSED, IN WHOLE OR PART, TO ANY UNAUTHORIZED PERSON OR ENTITY NOR REPRODUCED, TRANSFERRED OR INCORPORATED IN ANY OTHER PROJECT IN ANY MANNER WITHOUT THE EXPRESS WRITTEN CONSENT OF SAMTEC, INC.

DO NOT SCALE DRAWING

SHEET SCALE: 2:1



520 PARK EAST BLVD, NEW ALBANY, IN 47150  
 PHONE: 812-944-6733 FAX: 812-948-5047  
 e-Mail: info@SAMTEC.com code 55322

DESCRIPTION: RF058 CABLE ASSEMBLY

DWG. NO. RF058-XXXXX-XXXXXX-XXXX

BY: TIM P. 5/6/2005 SHEET 3 OF 7

FIG 5  
-01BJX SHOWN

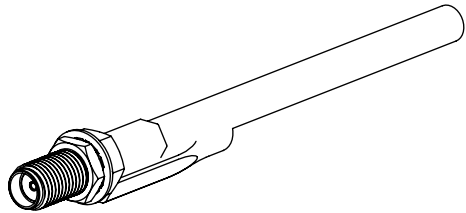
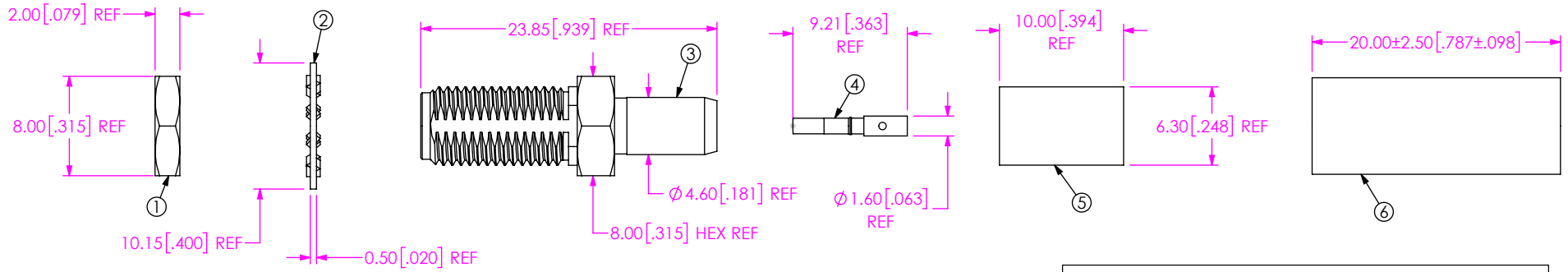

BOM		
ITEM	COMPONENT	-01BJ1
1	HEX NUT	SMA-NUT-001-F
2	LOCK WASHER	SMA-LWAS-001-F
3	SUB ASSEMBLY	SUB-SMA-J-C-F-ST-B10
4	SOCKET	SMA-J-C-H-ST-B10-SKT
5	FERRULE	TNC-FER-003-F
6	HEAT SHRINK TUBE	HST-0.250-02-BLK

FIG 6  
-01SBX SHOWN

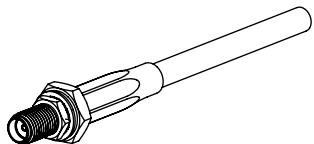
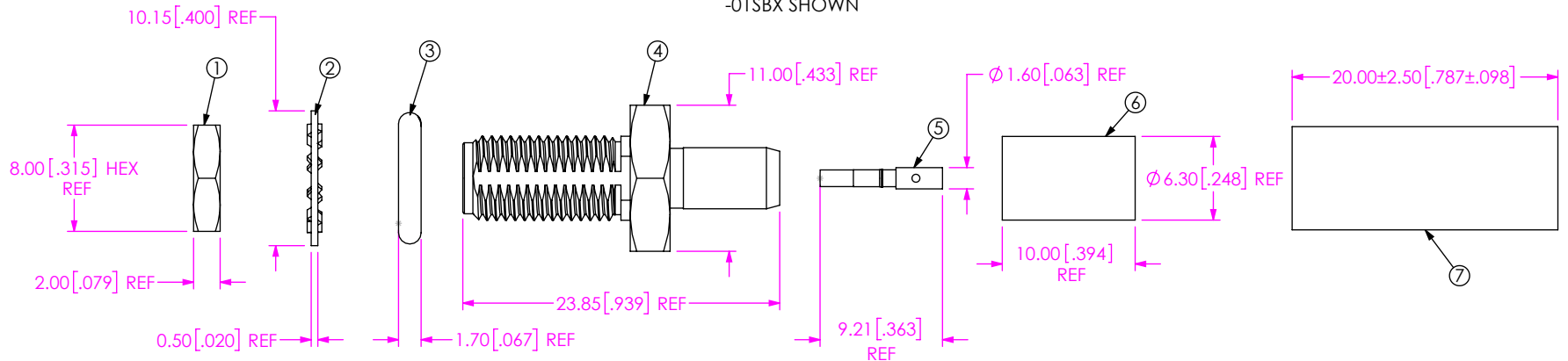

BOM		
ITEM	COMPONENT	-01SB1
1	HEX NUT	SMA-NUT-001-F
2	LOCK WASHER	SMA-LWAS-001-F
3	GASKET	SMA-GKT-002
4	SUB ASSEMBLY	SUB-SMA-J-C-F-ST-S10
5	SOCKET	SMA-J-C-H-ST-B10-SKT
6	FERRULE	TNC-FER-003-F
7	HEAT SHRINK TUBE	HST-0.250-02-BLK

**PROPRIETARY NOTE**  
THIS DOCUMENT CONTAINS CONFIDENTIAL AND PROPRIETARY INFORMATION AND ALL DESIGN, MANUFACTURING, REPRODUCTION, USE, PATENT RIGHTS AND SALES RIGHTS ARE EXPRESSLY RESERVED BY SAMTEC, INC. THIS DOCUMENT SHALL NOT BE DISCLOSED, IN WHOLE OR PART, TO ANY UNAUTHORIZED PERSON OR ENTITY NOR REPRODUCED, TRANSFERRED OR INCORPORATED IN ANY OTHER PROJECT IN ANY MANNER WITHOUT THE EXPRESS WRITTEN CONSENT OF SAMTEC, INC.



520 PARK EAST BLVD, NEW ALBANY, IN 47150  
PHONE: 812-944-6733 FAX: 812-948-5047  
e-Mail info@SAMTEC.com code 55322

DO NOT SCALE DRAWING

SHEET SCALE: 2:1

DESCRIPTION:  
RF058 CABLE ASSEMBLY

DWG. NO.  
RF058-XXXXX-XXXXXX-XXXX

BY: TIM P. 5/6/2005 SHEET 4 OF 7

FIG 7  
-01SPX SHOWN

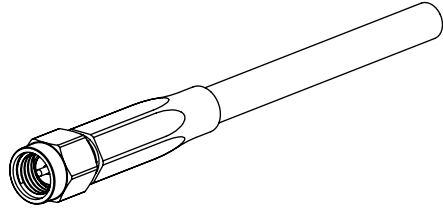
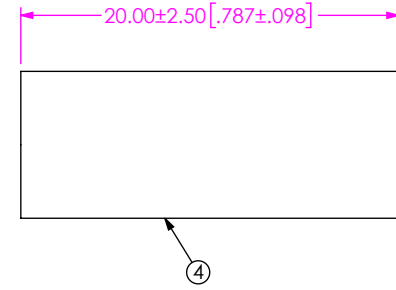
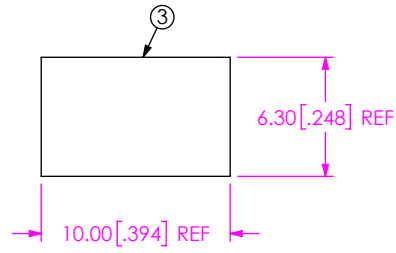
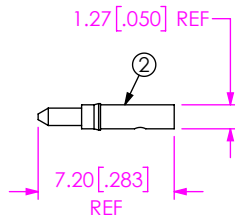
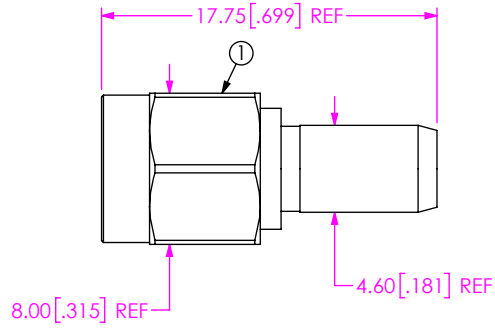

BOM		
ITEM	COMPONENT	-01SP1
1	SUB ASSEMBLY	SUB-SMA-P-C-F-ST-C10
2	PIN	SMA-PIN-010-H
3	FERRULE	TNC-FER-003-F
4	HEAT SHRINK TUBE	HST-0.250-02-BLK

**PROPRIETARY NOTE**  
THIS DOCUMENT CONTAINS CONFIDENTIAL AND PROPRIETARY INFORMATION AND ALL DESIGN, MANUFACTURING, REPRODUCTION, USE, PATENT RIGHTS AND SALES RIGHTS ARE EXPRESSLY RESERVED BY SAMTEC, INC. THIS DOCUMENT SHALL NOT BE DISCLOSED, IN WHOLE OR PART, TO ANY UNAUTHORIZED PERSON OR ENTITY NOR REPRODUCED, TRANSFERRED OR INCORPORATED IN ANY OTHER PROJECT IN ANY MANNER WITHOUT THE EXPRESS WRITTEN CONSENT OF SAMTEC, INC.



520 PARK EAST BLVD, NEW ALBANY, IN 47150  
PHONE: 812-944-6733 FAX: 812-948-5047  
e-Mail info@SAMTEC.com code 55322

DO NOT SCALE DRAWING  
SHEET SCALE: 2.5:1

DESCRIPTION: RF058 CABLE ASSEMBLY  
DWG. NO. RF058-XXXXX-XXXXXX-XXXX  
BY: TIM P. 5/6/2005 SHEET 5 OF 7

**IN PROCESS 1**  
CUT CABLE TO LENGTH

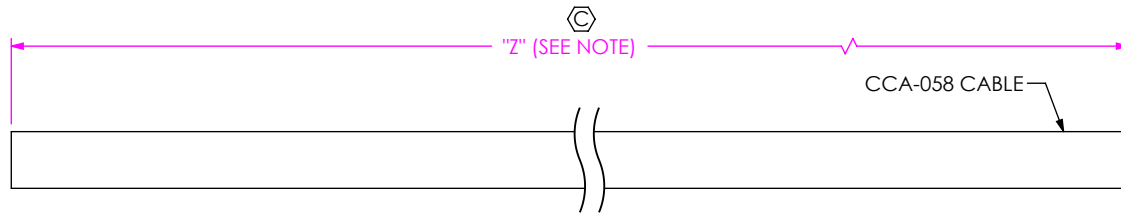

NOTE: "Z" = 2 \* OAL - 2 \* ["Y"(END 1)] (FOR -SING OR -XXXXXX OPTIONS)  
 "Z" = OAL - "Y"(END 1) - "Y"(END 2) (FOR DOUBLE ENDED OPTIONS)

**IN PROCESS 2**  
STRIP AND TIN INNER CONDUCTOR

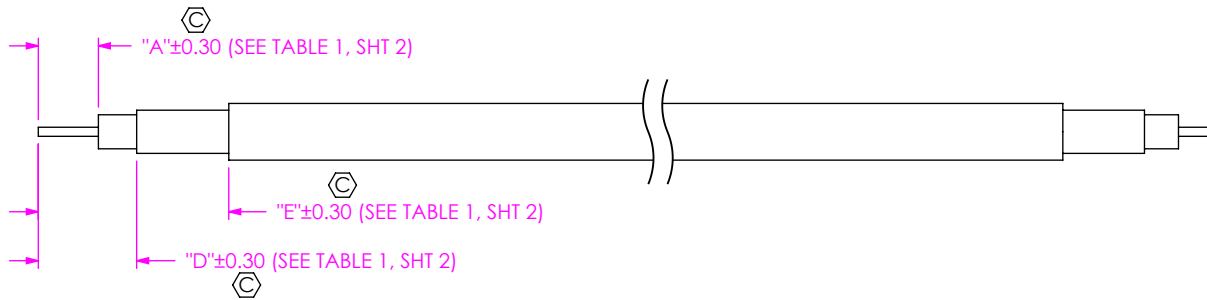

**IN PROCESS 3**  
ADD FERRULE, HEAT SHRINK TUBE & INSULATOR (IF APPLICABLE)  
SOLDER SIGNAL PIN

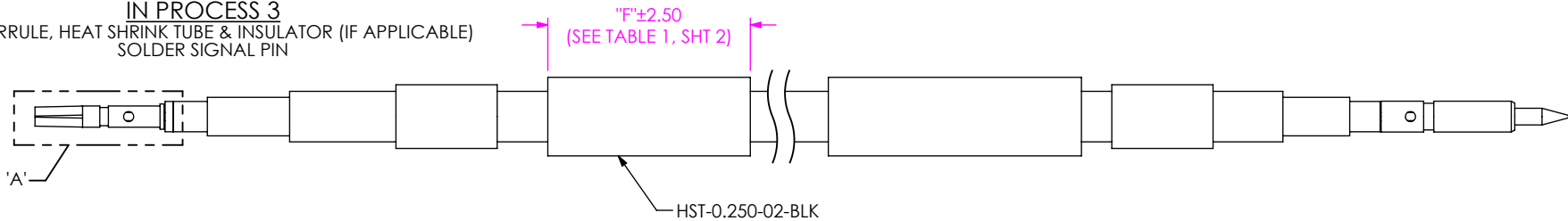

HST-0.250-02-BLK

**IN PROCESS 4**  
FLARE SHIELD,  
ADD SUB ASSEMBLY  
(SEE NOTE 6)

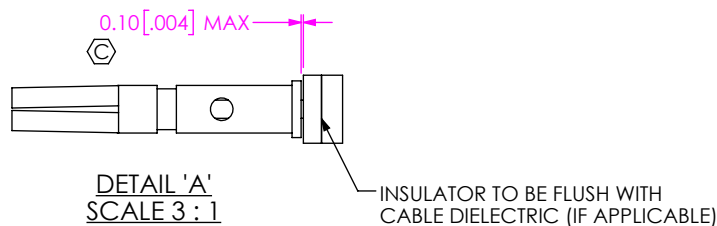
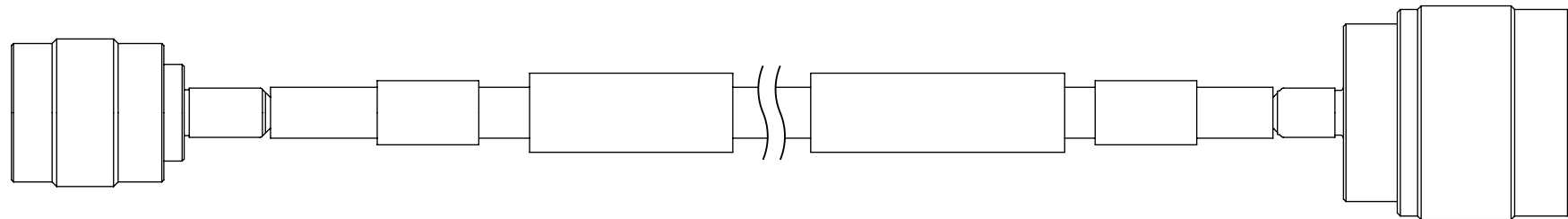

**PROPRIETARY NOTE**  
 THIS DOCUMENT CONTAINS CONFIDENTIAL AND PROPRIETARY INFORMATION AND ALL DESIGN, MANUFACTURING, REPRODUCTION, USE, PATENT RIGHTS AND SALES RIGHTS ARE EXPRESSLY RESERVED BY SAMTEC, INC. THIS DOCUMENT SHALL NOT BE DISCLOSED, IN WHOLE OR PART, TO ANY UNAUTHORIZED PERSON OR ENTITY NOR REPRODUCED, TRANSFERRED OR INCORPORATED IN ANY OTHER PROJECT IN ANY MANNER WITHOUT THE EXPRESS WRITTEN CONSENT OF SAMTEC, INC.

DO NOT SCALE DRAWING  
 SHEET SCALE: 1.5:1



520 PARK EAST BLVD, NEW ALBANY, IN 47150  
 PHONE: 812-944-6733 FAX: 812-948-5047  
 e-Mail: info@SAMTEC.com code 55322

DESCRIPTION:  
 RF058 CABLE ASSEMBLY

DWG. NO.  
 RF058-XXXXX-XXXXXX-XXXX

BY: TIM P. 5/6/2005 SHEET 6 OF 7

IN PROCESS 5  
CRIMP FERRULE

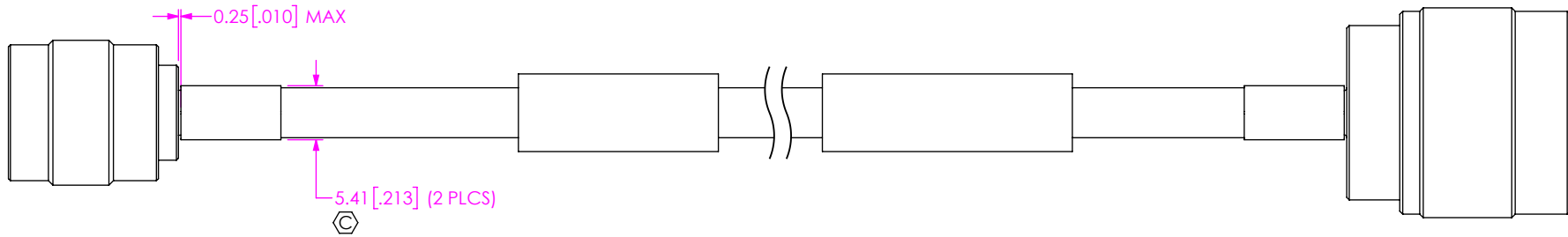

IN PROCESS 6  
ACTIVATE HEAT SHRINK

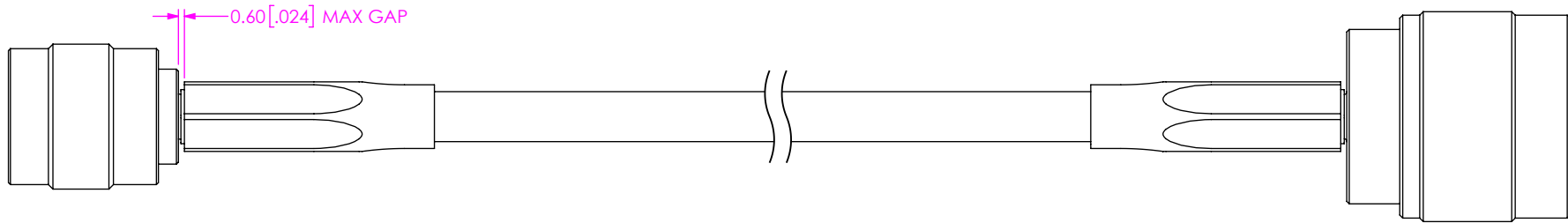

F:\DWG\MISC\MKTG\RF058-XXXX-XXXX-XXXX-MKT.SLDDRW

**PROPRIETARY NOTE**  
 \* THIS DOCUMENT CONTAINS CONFIDENTIAL AND PROPRIETARY INFORMATION AND ALL DESIGN, MANUFACTURING, REPRODUCTION, USE, PATENT RIGHTS AND SALES RIGHTS ARE EXPRESSLY RESERVED BY SAMTEC, INC. THIS DOCUMENT SHALL NOT BE DISCLOSED, IN WHOLE OR PART, TO ANY UNAUTHORIZED PERSON OR ENTITY NOR REPRODUCED, TRANSFERRED OR INCORPORATED IN ANY OTHER PROJECT IN ANY MANNER WITHOUT THE EXPRESS WRITTEN CONSENT OF SAMTEC, INC. \*



520 PARK EAST BLVD, NEW ALBANY, IN 47150  
 PHONE: 812-944-6733 FAX: 812-948-5047  
 e-Mail info@SAMTEC.com code 55322

DO NOT SCALE DRAWING

SHEET SCALE: 1.5:1



DESCRIPTION: RF058 CABLE ASSEMBLY

DWG. NO. RF058-XXXX-XXXX-XXXX

BY: TIM P. 5/6/2005 SHEET 7 OF 7

## Looking for pricing, stock, or lifecycle information?

Click below to explore more details on WIN SOURCE:

-  [View RF058-06SP2-303030-0350 on WIN SOURCE](#)
-  [Samtec Inc. Information](#)

## Optimize Your Supply Chain with WIN SOURCE Solutions

-  Global Sourcing Solution
-  Obsolete Management
-  Cost Control Management
-  Shortage Management
-  Alternative Solution
-  Excess Inventory Management