



**THE DATASHEET OF
SO-1890-02-01-01-L**



DO NOT SCALE FROM THIS PRINT

DESIGNED & DIMENSIONED IN MILLIMETERS [INCHES]

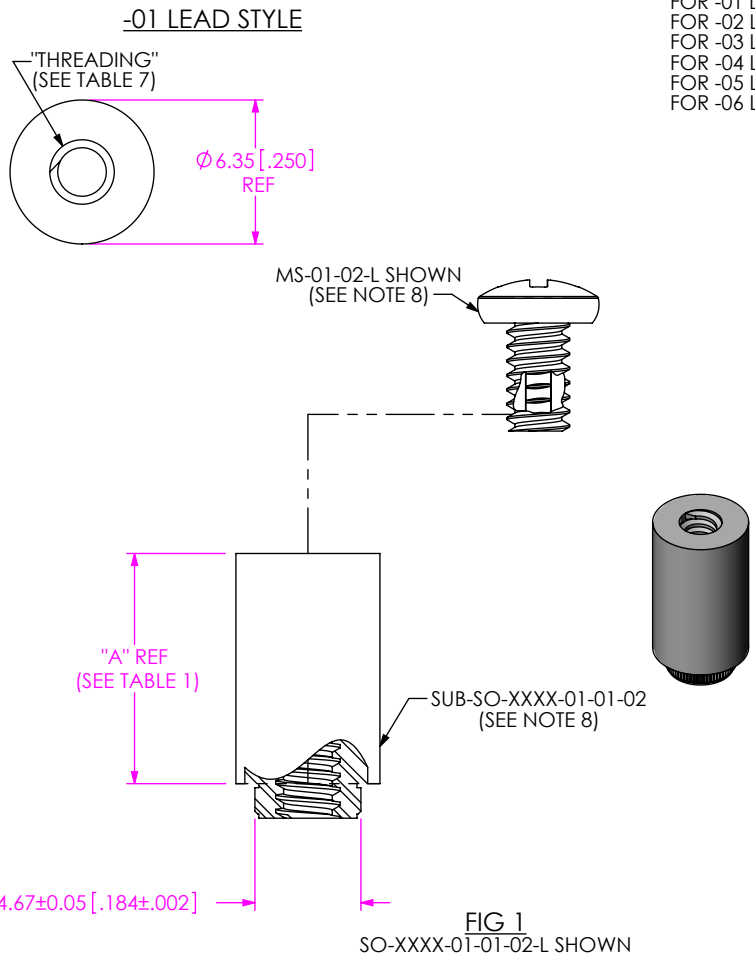

FIG 1
SO-XXXX-01-01-02-L SHOWN

- NOTES:
- NOTE DELETED
 - NOTE DELETED
 - NOTE DELETED
 - STANDOFFS TO BE USED WITH 1.57 [0.062] MIN THICK BOARDS THICK BOARDS. THREADED OPTIONS PCB MAX THICKNESS OF 3.16 [0.124]
 - NOTE DELETED.
 - NOTE DELETED
 - NOTE DELETED.
 - COMPONENTS ARE TO BE PACKAGED IN SEPARATE BAGS UNASSEMBLED AND NOT LABELED. COMBINE SEPARATE BAGS IN ONE LARGER BAG WITH PART NUMBER AND QUANTITY.
 - NOTE DELETED
 - NOTE DELETED
 - NOTE DELETED.
 - REPRESENTS A CRITICAL DIMENSION.
 - STANDOFFS ARE DESIGNED .15MM LONGER THAN CONNECTOR STACK HEIGHTS TO ALLOW FOR PROCESSING VARIABLES.
 - TORQUE TO 2.5 – 3.5 IN*LBS TO SECURE FASTENER IN A STATIC ENVIRONMENT ASSUMING RECOMMENDED BOARD TO BOARD DISTANCES ARE ACHIEVED WITHOUT DAMAGE TO THE PCB, HARDWARE OR OTHER COMPONENTS.
 - FOR -L OPTION, SPREAD LOCKING COMPOUND OVER 5 THREADS OR AT LEAST 0.105".

SO-XXXX-XX-XX-XX-X-X

BOARD STACK HEIGHT

- FOR -01 LEAD STYLE: SEE TABLE 1
- FOR -02 LEAD STYLE: SEE TABLE 3, SHEET 2
- FOR -03 LEAD STYLE: SEE TABLE 4, SHEET 3
- FOR -04 LEAD STYLE: SEE TABLE 5, SHEET 4
- FOR -05 LEAD STYLE: SEE TABLE 6, SHEET 5
- FOR -06 LEAD STYLE: SEE TABLE 8, SHEET 6

KIT OPTION

- N: NO HARDWARE (STANDOFF ONLY; SEE TABLE 2) LEAVE BLANK FOR KIT

LOCKING OPTION

- L: LOCKING COMPOUND (NOT AVAILABLE WITH -04 LEAD STYLE OR -N OPTION ON -01 AND -05 LEAD STYLES)

MATERIAL

- 01: 6061 ALUMINUM
- 02: 303 STAINLESS STEEL
- 03: 304 STAINLESS STEEL (AVAILABLE FOR -04 LEAD STYLE ONLY)

THREADING

- 01: #4-40
- 02: M3 x 0.5 x 4.76mm
- 03: M2 x 0.4 x 4.76mm

LEAD STYLE

- 01: FEMALE THREAD/PRESS-IN (SEE FIG 1, SHT 1) SEE NOTE 6
- 02: MALE/MALE THREADED (SEE FIG 2, SHT 2) SEE NOTE 7
- 03: MALE/FEMALE THREADED (SEE FIG 3, SHT 3) SEE NOTE 10
- 04: FEMALE/PRESS-IN (SEE FIG 4, SHT 4) SEE NOTE 9
- 05: FEMALE/FEMALE THREADED (SEE FIG 5 SHT 5)
- 06: MALE/MALE THREADED (SEE FIG 6, SHT 6)

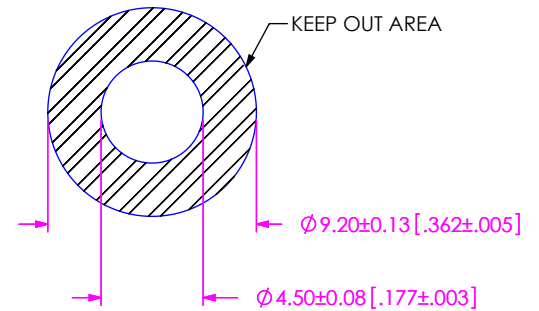

RECOMMENDED BOARD CUTOUT (PRESS-IN)

| TABLE 1 | |
|----------------------------|--------------|
| 01 LEAD STYLE AVAILABILITY | |
| BOARD STACK HEIGHT | "A" |
| -0515 | 5.15 [0.203] |
| -0575 | 5.75 [0.226] |
| -0600 | 6.00 [0.236] |
| -0690 | 6.90 [0.272] |
| -0715 | 7.15 [0.281] |
| -0815 | 8.15 [0.321] |
| -0865 | 8.65 [0.341] |
| -0915 | 9.15 [0.360] |
| -0965 | 9.65 [0.380] |

| TABLE 7 | |
|-----------|------------------------------|
| THREADING | |
| -01 | #4-40 UNC 2A #4-40 UNC 2B |
| -02 | M3 x 0.5 6g M3 x 0.5 6H |
| -03 | M2 x 0.4 6g M2 x 0.4 6H |

UNLESS OTHERWISE SPECIFIED, DIMENSIONS ARE IN MILLIMETERS. TOLERANCES ARE:
DECIMALS ANGLES
X.X: ±0.25 [0.01] 2°
X.XX: ±0.05 [0.002]

PROPRIETARY NOTE
THIS DOCUMENT CONTAINS CONFIDENTIAL AND PROPRIETARY INFORMATION AND ALL DESIGN, MANUFACTURING, REPRODUCTION, USE, PATENT RIGHTS AND SALES RIGHTS ARE EXPRESSLY RESERVED BY SAMTEC, INC. THIS DOCUMENT SHALL NOT BE DISCLOSED, IN WHOLE OR PART, TO ANY UNAUTHORIZED PERSON OR ENTITY NOR REPRODUCED, TRANSFERRED OR INCORPORATED IN ANY OTHER PROJECT IN ANY MANNER WITHOUT THE EXPRESS WRITTEN CONSENT OF SAMTEC, INC.



520 PARK EAST BLVD. NEW ALBANY, IN 47150
PHONE: 812-944-6733 FAX: 812-948-5047
e-Mail info@SAMTEC.com code 55322

MATERIAL: DO NOT SCALE DRAWING SHEET SCALE: 3:1
SEE PART CALL OUT FOR MATERIAL

DESCRIPTION: BOARD TO BOARD STANDOFF

DWG. NO. SO-XXXX-XX-XX-XX-X

BY: T.NEWTON 12/6/2007 **SHEET 1 OF 7**

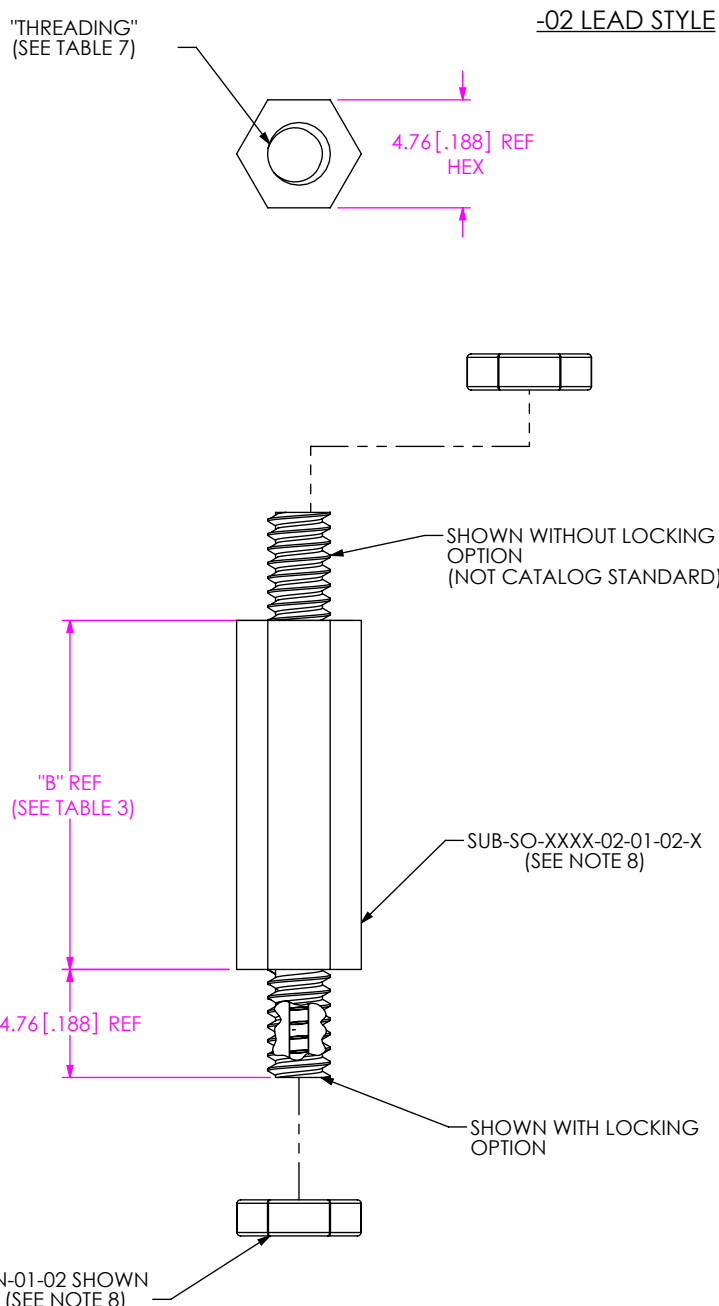
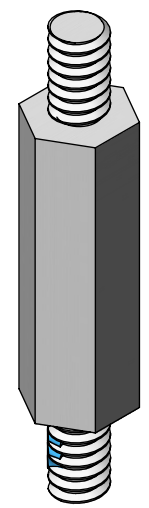
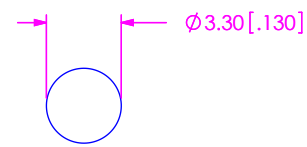

FIG 2
SO-XXXX-02-01-02-X SHOWN



| TABLE 3 | |
|-------------------------------|---------------|
| 02 LEAD STYLE AVAILABILITY | |
| BOARD STACK HEIGHT | "B" |
| -0515 | 5.15 [.203] |
| -0715 | 7.15 [.282] |
| -0865 | 8.65 [.341] |
| -1015 | 10.15 [.400] |
| -1115 | 11.15 [.439] |
| -1215 | 12.15 [.478] |
| -1315 | 13.15 [.518] |
| -1415 | 14.15 [.557] |
| -1515 | 15.15 [.597] |
| -1524 | 15.24 [.600] |
| -1615 | 16.15 [.636] |
| -1715 | 17.15 [.675] |
| -1890 | 18.90 [.744] |
| -1915 | 19.15 [.754] |
| -2015 | 20.15 [.793] |
| -2215 | 22.15 [.872] |
| -2515 | 25.15 [.990] |
| -3015 | 30.15 [1.187] |



RECOMMENDED BOARD
CUTOUT (#4-40)

PROPRIETARY NOTE
THIS DOCUMENT CONTAINS CONFIDENTIAL AND PROPRIETARY INFORMATION AND ALL DESIGN, MANUFACTURING, REPRODUCTION, USE, PATENT RIGHTS AND SALES RIGHTS ARE EXPRESSLY RESERVED BY SAMTEC, INC. THIS DOCUMENT SHALL NOT BE DISCLOSED, IN WHOLE OR PART, TO ANY UNAUTHORIZED PERSON OR ENTITY NOR REPRODUCED, TRANSFERRED OR INCORPORATED IN ANY OTHER PROJECT IN ANY MANNER WITHOUT THE EXPRESS WRITTEN CONSENT OF SAMTEC, INC.



520 PARK EAST BLVD, NEW ALBANY, IN 47150
PHONE: 812-944-6733 FAX: 812-948-5047
e-Mail info@SAMTEC.com code 55322

DO NOT SCALE DRAWING

DESCRIPTION: BOARD TO BOARD STANDOFF

DWG. NO. SO-XXXX-XX-XX-XX-X

SHEET SCALE: 1:0.333333

BY: T.NEWTON 12/6/2007 SHEET 2 OF 7

-04 LEAD STYLE

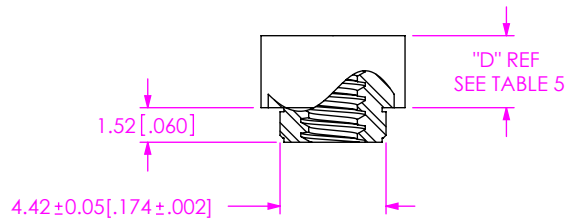
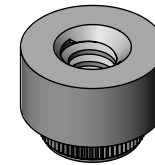
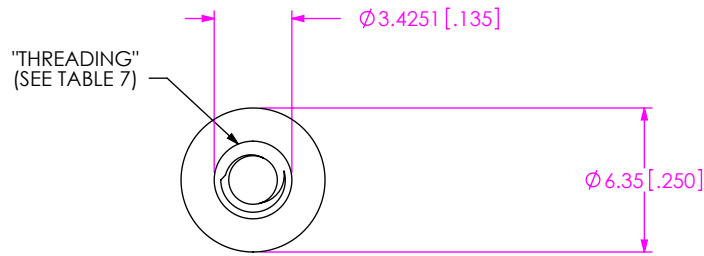
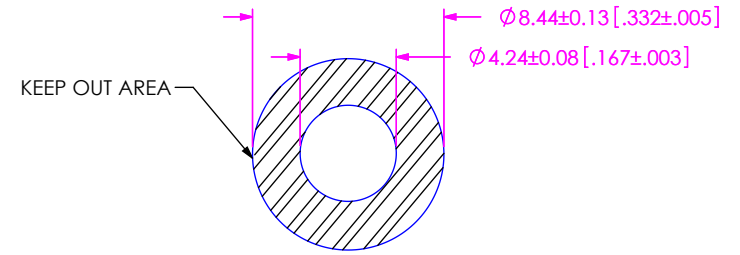



FIG 4
SO-XXXX-04-01-02 SHOWN



RECOMMENDED BOARD
CUTOUT (PRESS-IN)

| TABLE 5 | |
|----------------------------|-------------|
| 04 LEAD STYLE AVAILABILITY | |
| BOARD STACK HEIGHT | "D" |
| -0165 | 1.65 [.065] |
| -0175 | 1.75 [.069] |
| -0310 | 3.10 [.122] |
| -0318 | 3.18 [.125] |

| | | |
|---|---|---|
| <p>PROPRIETARY NOTE</p> <p>THIS DOCUMENT CONTAINS CONFIDENTIAL AND PROPRIETARY INFORMATION AND ALL DESIGN, MANUFACTURING, REPRODUCTION, USE, PATENT RIGHTS AND SALES RIGHTS ARE EXPRESSLY RESERVED BY SAMTEC, INC. THIS DOCUMENT SHALL NOT BE DISCLOSED, IN WHOLE OR PART, TO ANY UNAUTHORIZED PERSON OR ENTITY NOR REPRODUCED, TRANSFERRED OR INCORPORATED IN ANY OTHER PROJECT IN ANY MANNER WITHOUT THE EXPRESS WRITTEN CONSENT OF SAMTEC, INC.</p> |  <p>520 PARK EAST BLVD, NEW ALBANY, IN 47150 PHONE: 812-944-6733 FAX: 812-948-5047 e-Mail info@SAMTEC.com code 55322</p> | |
| | <p>DO NOT SCALE DRAWING</p> | <p>DESCRIPTION: BOARD TO BOARD STANDOFF</p> |
| <p>SHEET SCALE: 1:0.333333</p> | <p>BY: T.NEWTON 12/6/2007</p> | <p>SHEET 4 OF 7</p> |

-05 LEAD STYLE

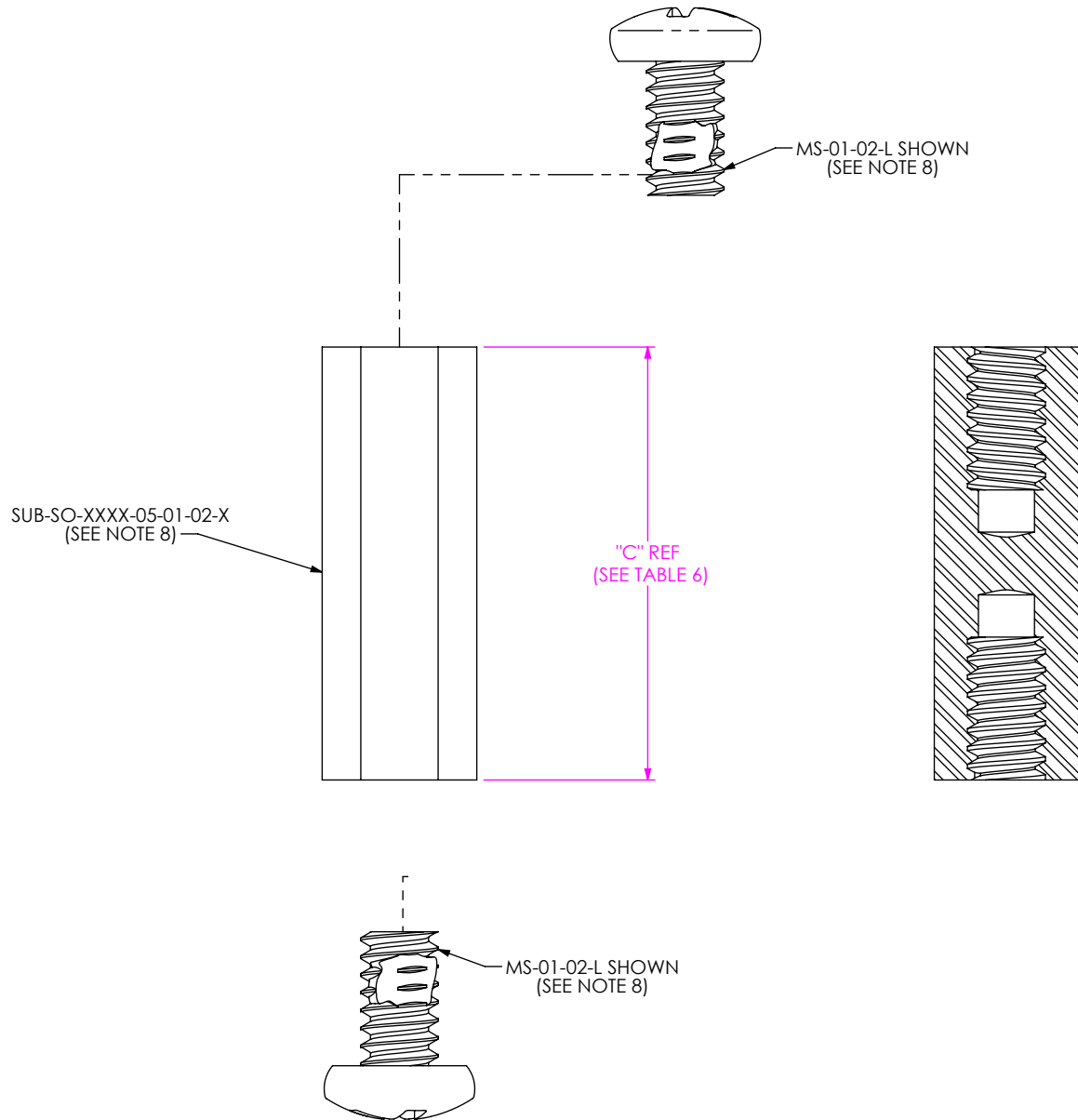
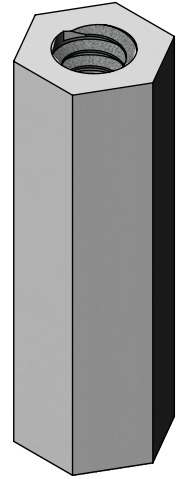

| TABLE 6 | |
|----------------------------|--------------|
| 05 LEAD STYLE AVAILABILITY | |
| BOARD STACK HEIGHT | "C" |
| -0515 | 5.15 [.203] |
| -0700 | 7.00 [.276] |
| -0915 | 9.15 [.360] |
| -1015 | 10.15 [.400] |
| -1115 | 11.15 [.439] |
| -1215 | 12.15 [.478] |
| -1315 | 13.15 [.518] |
| -1415 | 14.15 [.557] |
| -1515 | 15.15 [.596] |
| -1524 | 15.24 [.600] |
| -1615 | 16.15 [.636] |
| -1715 | 17.15 [.675] |
| -1890 | 18.90 [.744] |
| -1915 | 19.15 [.754] |
| -2015 | 20.15 [.793] |
| -2200 | 22.00 [.866] |
| -2215 | 22.15 [.872] |
| -2515 | 25.15 [.990] |

FIG 5
SO-XXXX-05-01-02-X SHOWN
(SAME AS -02 LEAD STYLE,
EXCEPT WHERE STATED)

PROPRIETARY NOTE
THIS DOCUMENT CONTAINS CONFIDENTIAL AND PROPRIETARY INFORMATION AND ALL DESIGN, MANUFACTURING, REPRODUCTION, USE, PATENT RIGHTS AND SALES RIGHTS ARE EXPRESSLY RESERVED BY SAMTEC, INC. THIS DOCUMENT SHALL NOT BE DISCLOSED, IN WHOLE OR PART, TO ANY UNAUTHORIZED PERSON OR ENTITY NOR REPRODUCED, TRANSFERRED OR INCORPORATED IN ANY OTHER PROJECT IN ANY MANNER WITHOUT THE EXPRESS WRITTEN CONSENT OF SAMTEC, INC.



520 PARK EAST BLVD, NEW ALBANY, IN 47150
PHONE: 812-944-6733 FAX: 812-948-5047
e-Mail info@SAMTEC.com code 55322

DO NOT SCALE DRAWING

DESCRIPTION: BOARD TO BOARD STANDOFF

DWG. NO. SO-XXXX-XX-XX-XX-X

SHEET SCALE: 1:1

BY: T.NEWTON 12/6/2007 SHEET 5 OF 7

-06 LEAD STYLE

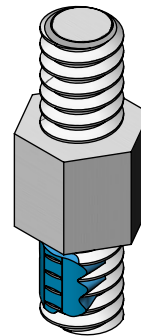
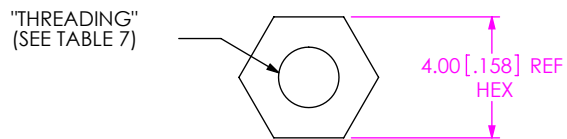

| TABLE 8 | |
|----------------------------|-------------|
| 06 LEAD STYLE AVAILABILITY | |
| BOARD STACK HEIGHT | "B" |
| -0375 | 3.75 [.148] |

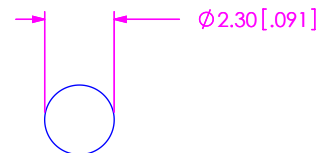
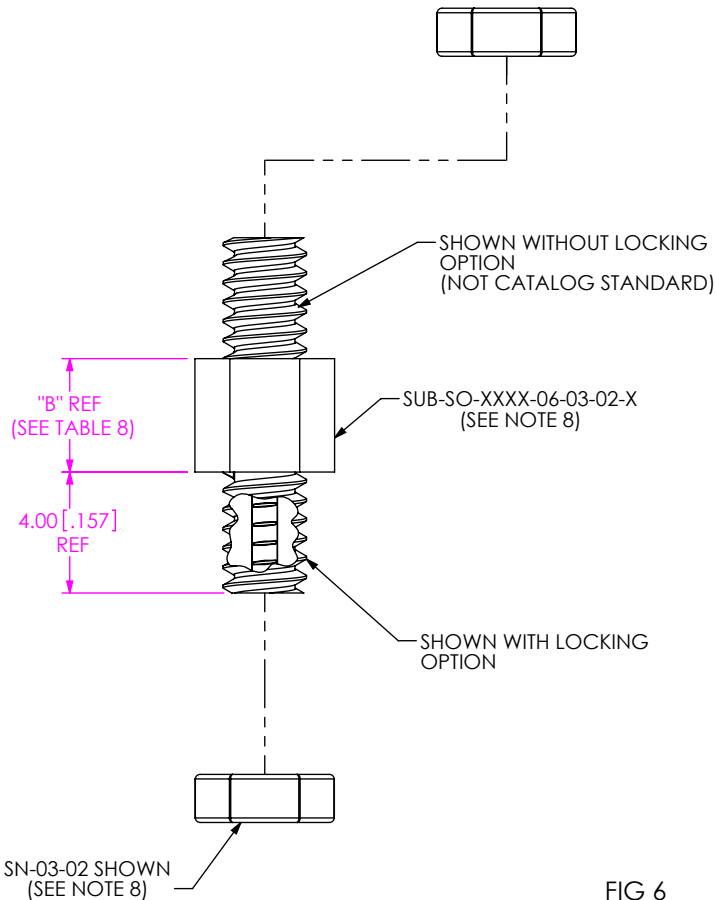

RECOMMENDED BOARD CUTOUT (M2 x 0.4)

FIG 6
SO-XXXX-06-03-02-X SHOWN
(SAME AS -02 LEAD STYLE,
EXCEPT WHERE STATED)

PROPRIETARY NOTE
THIS DOCUMENT CONTAINS CONFIDENTIAL AND PROPRIETARY INFORMATION AND ALL DESIGN, MANUFACTURING, REPRODUCTION, USE, PATENT RIGHTS AND SALES RIGHTS ARE EXPRESSLY RESERVED BY SAMTEC, INC. THIS DOCUMENT SHALL NOT BE DISCLOSED, IN WHOLE OR PART, TO ANY UNAUTHORIZED PERSON OR ENTITY NOR REPRODUCED, TRANSFERRED OR INCORPORATED IN ANY OTHER PROJECT IN ANY MANNER WITHOUT THE EXPRESS WRITTEN CONSENT OF SAMTEC, INC.



520 PARK EAST BLVD, NEW ALBANY, IN 47150
PHONE: 812-944-6733 FAX: 812-948-5047
e-Mail info@SAMTEC.com code 55322

DO NOT SCALE DRAWING

DESCRIPTION: BOARD TO BOARD STANDOFF

DWG. NO. SO-XXXX-XX-XX-XX-X

SHEET SCALE: 4:1

BY: T.NEWTON 12/6/2007 SHEET 6 OF 7

| TABLE 2 - BOM | | | | | | |
|----------------------|------------------------|-----|------------|-----|----------|-----|
| FINISHED GOOD | STANDOFF | QTY | SCREW | QTY | NUT | QTY |
| SO-XXXX-01-01-XX | SUB-SO-XXXX-01-01-XX | 1 | MS-01-XX | 1 | N/A | |
| SO-XXXX-01-01-XX-N | SUB-SO-XXXX-01-01-XX | 1 | N/A | | N/A | |
| SO-XXXX-01-01-XX-L | SUB-SO-XXXX-01-01-XX | 1 | MS-01-XX-L | 1 | N/A | |
| SO-XXXX-02-01-XX | SUB-SO-XXXX-02-01-XX | 1 | N/A | | SN-01-XX | 2 |
| SO-XXXX-02-01-XX-N | SUB-SO-XXXX-02-01-XX | 1 | N/A | | N/A | |
| SO-XXXX-02-01-XX-L | SUB-SO-XXXX-02-01-XX-L | 1 | N/A | | SN-01-XX | 2 |
| SO-XXXX-02-01-XX-L-N | SUB-SO-XXXX-02-01-XX-L | 1 | N/A | | N/A | |
| SO-XXXX-03-01-XX | SUB-SO-XXXX-03-01-XX | 1 | MS-01-XX | 1 | SN-01-XX | 1 |
| SO-XXXX-03-01-XX-N | SUB-SO-XXXX-03-01-XX | 1 | N/A | | N/A | |
| SO-XXXX-03-01-XX-L | SUB-SO-XXXX-03-01-XX-L | 1 | MS-01-XX-L | 1 | SN-01-XX | 1 |
| SO-XXXX-03-01-XX-L-N | SUB-SO-XXXX-03-01-XX-L | 1 | N/A | | N/A | |
| SO-XXXX-05-01-XX | SUB-SO-XXXX-05-01-XX | 1 | MS-01-XX | 2 | N/A | |
| SO-XXXX-05-01-XX-N | SUB-SO-XXXX-05-01-XX | 1 | N/A | | N/A | |
| SO-XXX-05-01-XX-L | SUB-SO-XXX-05-01-XX | 1 | MS-01-XX-L | 2 | N/A | |
| SO-XXXX-01-02-XX | SUB-SO-XXXX-01-02-XX | 1 | MS-02-XX | 1 | N/A | |
| SO-XXXX-01-02-XX-N | SUB-SO-XXXX-01-02-XX | 1 | N/A | | N/A | |
| SO-XXXX-01-02-XX-L | SUB-SO-XXXX-01-02-XX | 1 | MS-02-XX-L | 1 | N/A | |
| SO-XXXX-02-02-XX | SUB-SO-XXXX-02-02-XX | 1 | N/A | | SN-02-XX | 2 |
| SO-XXXX-02-02-XX-N | SUB-SO-XXXX-02-02-XX | 1 | N/A | | N/A | |
| SO-XXXX-02-02-XX-L | SUB-SO-XXXX-02-02-XX-L | 1 | N/A | | SN-02-XX | 2 |
| SO-XXXX-02-02-XX-L-N | SUB-SO-XXXX-02-02-XX-L | 1 | N/A | | N/A | |
| SO-XXXX-02-03-XX-L | SUB-SO-XXXX-02-03-XX-L | 1 | N/A | | SN-03-XX | 2 |
| SO-XXXX-03-02-XX | SUB-SO-XXXX-03-02-XX | 1 | MS-02-XX | 1 | SN-02-XX | 1 |
| SO-XXXX-03-02-XX-N | SUB-SO-XXXX-03-02-XX | 1 | N/A | | N/A | |
| SO-XXXX-03-02-XX-L | SUB-SO-XXXX-03-02-XX-L | 1 | MS-02-XX-L | 1 | SN-02-XX | 1 |
| SO-XXXX-03-02-XX-L-N | SUB-SO-XXXX-03-02-XX-L | 1 | N/A | | N/A | |
| SO-XXXX-03-03-XX | SUB-SO-XXXX-03-03-XX | 1 | MS-06-XX | 1 | SN-03-XX | 1 |
| SO-XXXX-03-03-XX-N | SUB-SO-XXXX-03-03-XX | 1 | N/A | | N/A | |
| SO-XXXX-03-03-XX-L | SUB-SO-XXXX-03-03-XX-L | 1 | MS-06-XX-L | 1 | SN-03-XX | 1 |
| SO-XXXX-03-03-XX-L-N | SUB-SO-XXXX-03-03-XX-L | 1 | N/A | | N/A | |
| SO-XXXX-05-02-XX | SUB-SO-XXXX-05-02-XX | 1 | MS-02-XX | 2 | N/A | |
| SO-XXXX-05-02-XX-N | SUB-SO-XXXX-05-02-XX | 1 | N/A | | N/A | |
| SO-XXX-05-02-XX-L | SUB-SO-XXX-05-02-XX | 1 | MS-02-XX-L | 2 | N/A | |
| SO-XXX-05-03-XX | SUB-SO-XXX-05-03-XX | 1 | MS-06-XX | 2 | N/A | |
| SO-XXX-05-03-XX-L | SUB-SO-XXX-05-03-XX | 1 | MS-06-XX-L | 2 | N/A | |
| SO-XXXX-01-03-XX | SUB-SO-XXXX-01-03-XX | 1 | MS-06-XX | 1 | N/A | |

PROPRIETARY NOTE
 * THIS DOCUMENT CONTAINS CONFIDENTIAL AND PROPRIETARY INFORMATION AND ALL DESIGN, MANUFACTURING, REPRODUCTION, USE, PATENT RIGHTS AND SALES RIGHTS ARE EXPRESSLY RESERVED BY SAMTEC, INC. THIS DOCUMENT SHALL NOT BE DISCLOSED, IN WHOLE OR PART, TO ANY UNAUTHORIZED PERSON OR ENTITY NOR REPRODUCED, TRANSFERRED OR INCORPORATED IN ANY OTHER PROJECT IN ANY MANNER WITHOUT THE EXPRESS WRITTEN CONSENT OF SAMTEC, INC.



520 PARK EAST BLVD, NEW ALBANY, IN 47150
 PHONE: 812-944-6733 FAX: 812-948-5047
 e-Mail info@SAMTEC.com code 55322

DO NOT SCALE DRAWING

DESCRIPTION:
 BOARD TO BOARD STANDOFF

DWG. NO.
SO-XXXX-XX-XX-XX-X

BY: T.NEWTON 12/6/2007 SHEET 7 OF 7

SHEET SCALE: 4:1

Looking for pricing, stock, or lifecycle information?

Click below to explore more details on WIN SOURCE:

 [View SO-1890-02-01-01-L on WIN SOURCE](#)

 [Samtec Inc. Information](#)

Optimize Your Supply Chain with WIN SOURCE Solutions

-  Global Sourcing Solution
-  Obsolete Management
-  Cost Control Management
-  Shortage Management
-  Alternative Solution
-  Excess Inventory Management