

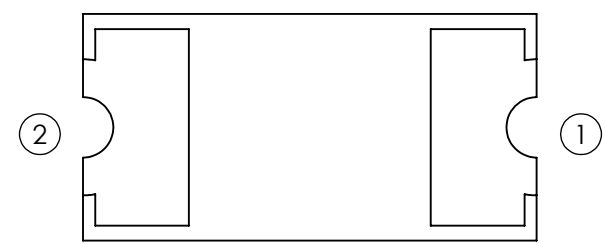

**THE DATASHEET OF
SML-LXL1206GC-TR**

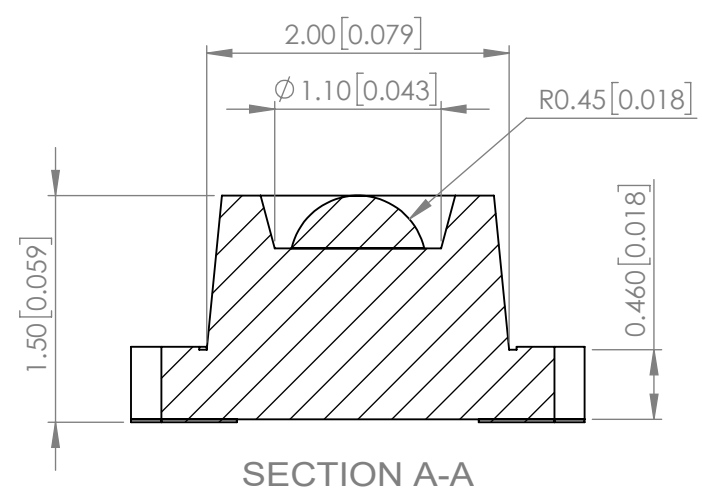

PART NUMBER	SML-LXL1206GC-TR	REV	H
REV	E.C.N. NUMBER AND REVISION COMMENTS	DATE	
A	E.C.N. #10BRDR. & REDRAWN.	03.30.98	
B	E.C.N. #10695.	01.08.01	
C	E.C.N. #10967.	03.14.03	
D	E.C.N. #11148.	03.17.05	
E	E.C.N. #11508.	05.26.10	
F	E.C.N. #11665.	10.12.10	
G	ECN-Lumex201700080	09.27.17	
H	ECN-Lumex202100066	12.10.21	

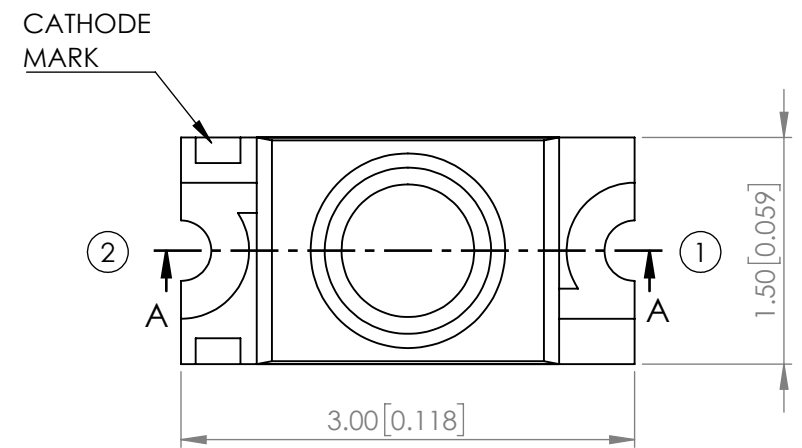

POLARITY

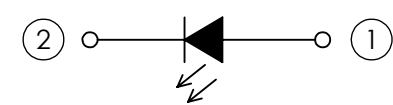

RECOMMENDED SOLDER PAD LAYOUT

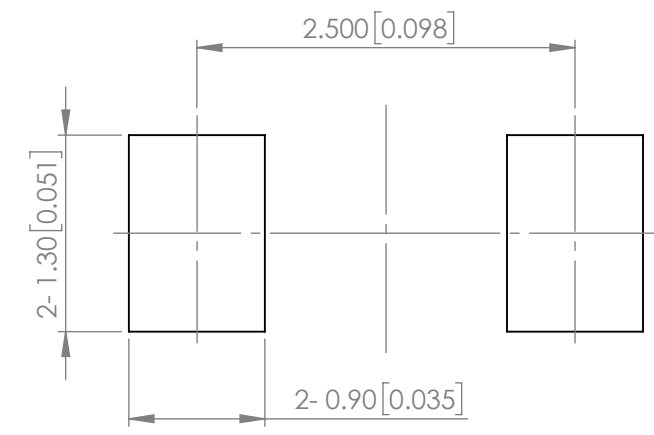

ELECTRO-OPTICAL CHARACTERISTIC TA=25°C

PARAMETER	MIN	TYP	MAX	UNITS	TEST COND
PEAK WAVELENGTH	-	575	-	nm	If=20mA
FORWARD VOLTAGE	-	2.0	2.4	Vf	If=20mA
REVERSE CURRENT	-	-	10	uA	VR=5V
LUMINOUS INTENSITY	-	29	-	mcd	If=20mA
VIEWING ANGLE	-	60	-	2x theta1/2	-
EMITTED COLOR	YELLOW GREEN				
EPOXY LENS FINISH	WATER CLEAR				

ABSOLUTE MAXIMUM RATINGS TA=25°C

PARAMETER	MAX	UNITS
PEAK FORWARD CURRENT*	60	mA
FORWARD CURRENT	25	mA
REVERSE VOLTAGE	5	V
POWER DISIPATION	60	mW
STORAGE TEMPERATURE	-40 TO +90	°C
OPERATING TEMPERATURE	-40 TO +85	°C

* 1/10 DUTY CYCLE 0.1ms PULSE.

**MOISTURE SENSITIVE DEVICE
PER JEDEC LEVEL 3 STANDARDS**

*UNLESS OTHERWISE SPECIFIED TOLERANCES PER DECIMAL PRECISION ARE: X=±1 (±0.039), X.X=±0.5 (±0.020), X.XX=±0.25 (±0.010), X.XXX=±0.127 (±0.005). LEAD SIZE=±0.05 (±0.002), LEAD LENGTH=±0.75 (±0.030). MIN= ^{+DECIMAL PRECISION} / _{-0.00} MAX= ^{+0.00} / _{-DECIMAL PRECISION}

PROFILE

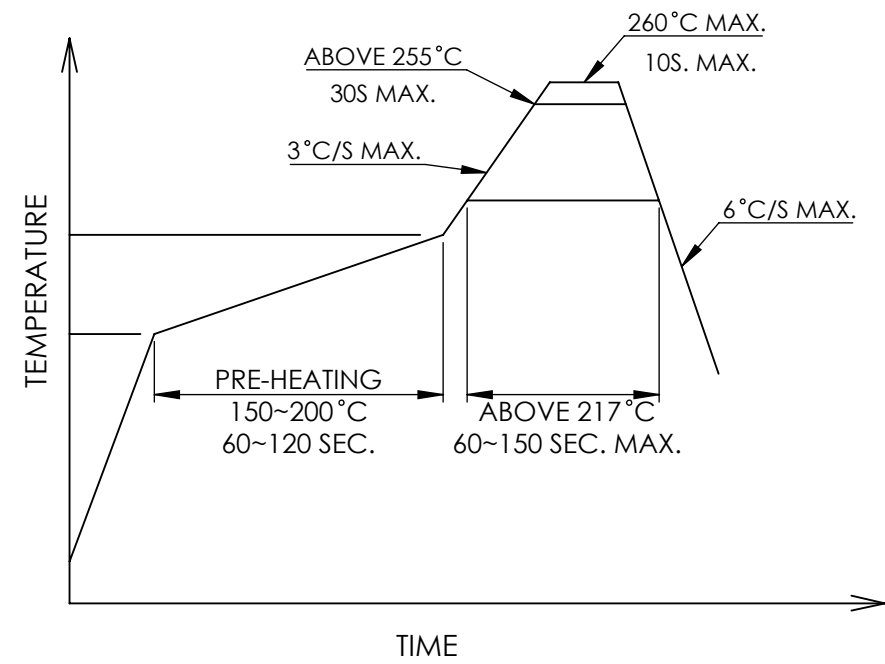

CARRIER TAPE DIMENSION

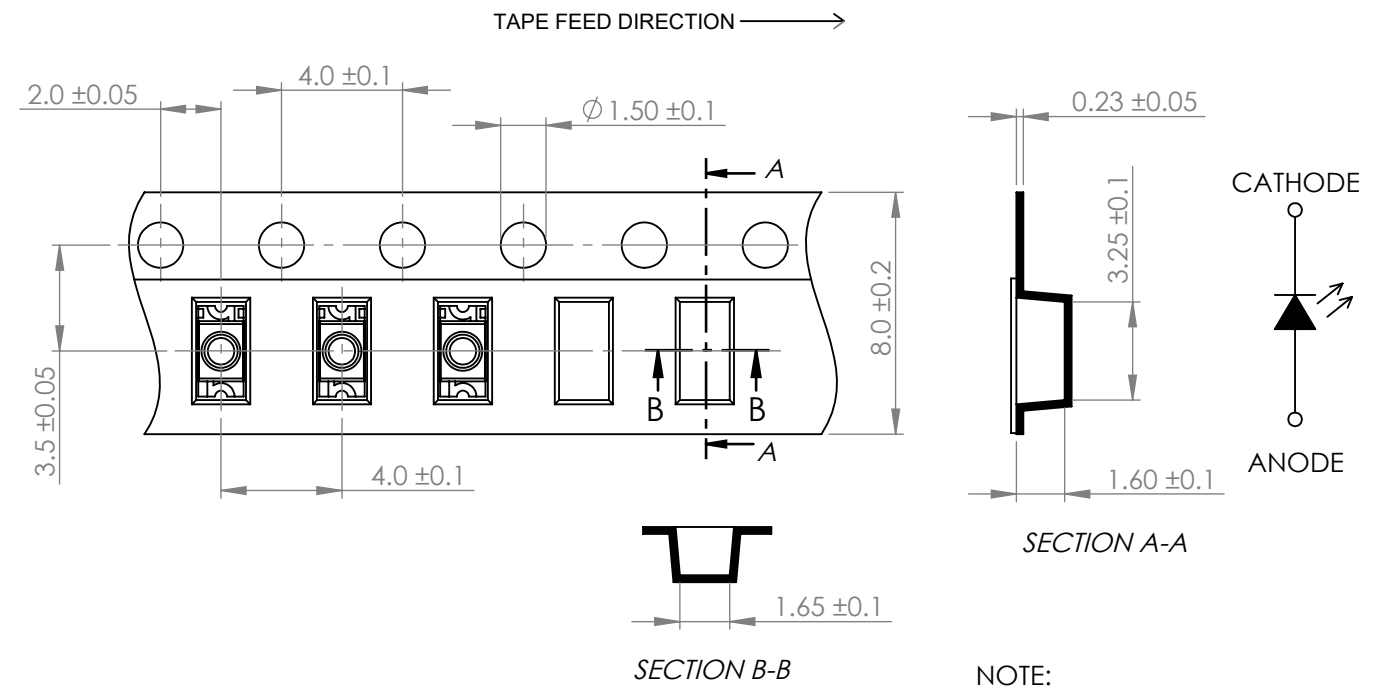

NOTE:
1. PACKAGE: 3000 PCS/REEL.

*UNLESS OTHERWISE SPECIFIED TOLERANCES PER DECIMAL PRECISION ARE: X=±1 (±0.039), X.X=±0.5 (±0.020), X.XX=±0.25 (±0.010), X.XXX=±0.127 (±0.005). LEAD SIZE=±0.05 (±0.002), LEAD LENGTH=±0.75 (±0.030). MIN= ^{+DECIMAL PRECISION} -0.00 MAX= ^{+0.00} -DECIMAL PRECISION

 <p>425 N. GARY AVE. CAROL STREAM, IL 60188 PHONE : 800-278-5666 FAX : 630-315-2150 WEB : WWW.LUMEX.COM</p>	3(L)*1.5(W)*1.5(H)mm, PCB SML WITH LENS, 575nm YELLOW GREEN LED, WATER CLEAR LENS, TAPE & REEL		DATE : 2017.09.27	DRAWN BY : C.C.	
	THE SPECIFICATIONS MAY CHANGE AT ANY TIME WITHOUT NOTICE.			PAGE : 2 OF 2	CHKD BY : G.Y.
	CONFIDENTIAL INFORMATION THE INFORMATION CONTAINED IN THIS DOCUMENT IS THE PROPERTY OF LUMEX INC. EXCEPT AS SPECIFICALLY AUTHORIZED IN WRITING BY LUMEX INC., THE HOLDER OF THIS DOCUMENT SHALL KEEP ALL INFORMATION CONTAINED HEREIN CONFIDENTIAL AND SHALL PROTECT SAME IN WHOLE OR IN PART FROM DISCLOSURE AND DISSEMINATION TO ALL THIRD PARTIES.			SCALE : NTF	APRVD BY : E.C.
				UNIT : mm [INCH]	(No)

Looking for pricing, stock, or lifecycle information?

Click below to explore more details on WIN SOURCE:

- ⊖ [View SML-LXL1206GC-TR on WIN SOURCE](#)
- ⊖ [Lumex Opto/Components Inc. Information](#)

Optimize Your Supply Chain with WIN SOURCE Solutions

- ✓ Global Sourcing Solution
- ✓ Obsolete Management
- ✓ Cost Control Management
- ✓ Shortage Management
- ✓ Alternative Solution
- ✓ Excess Inventory Management