



**THE DATASHEET OF  
CDRH6D28-220NC**



	SPECIFICATION	CUSTOMER:
	SUMIDA TYPE CDRH6D28	PART NO. REF. TO THE ATTACHED SHEET.

1. DIMENSION (UNIT mm)

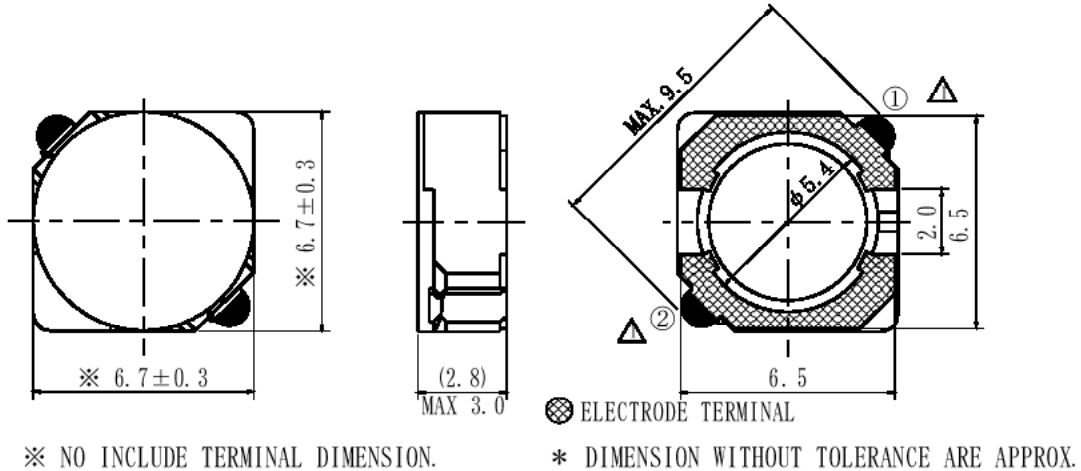

2. CONNECTION (BOTTOM)

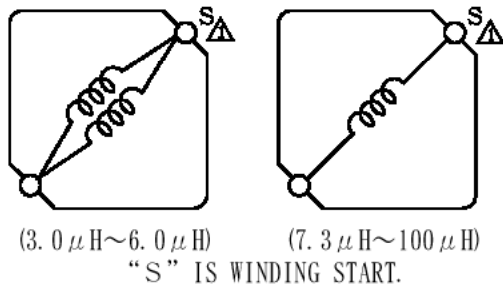

3. STAMP (Ex.)

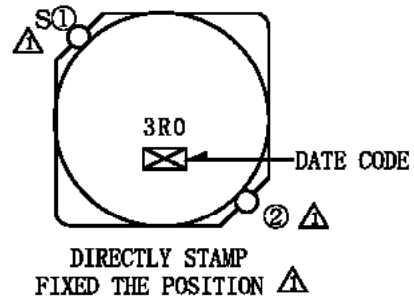

4. NOTE

- \* RECOMMENDED REFLOW CONDITION TO BE ACCORDING TO S-074-5003.
- \* ENCLOSING CONDITION OF COILS.  $\triangle$



- \* CARRIER TAPE PACKING SPECIFICATION IN DETAIL. (S-074-5075)

1st, Mar., 1999			SUMIDA CODE	4762
CHK.	CHK.	DRG.	DRG. NO. 2/5 S-074-6065	
LIU YUEJIANG	DENG WEISHI	YANG XIANYU S		

# GENERAL CHARACTERISTICS

TYPE

CDRH6D28

1. OPERATING TEMPERATURE RANGE:  $-25^{\circ}\text{C} \sim +85^{\circ}\text{C}$  (CONTAIN HEATING COIL)
2. STORAGE TEMPERATURE RANGE :  $-30^{\circ}\text{C} \sim +85^{\circ}\text{C}$
3. EXTERNAL APPEARANCE : NO EXTERNAL DEFECTS CAN BE FOUND IN THE VISUAL INSPECTION.
4. ELECTRODE STRENGTH : NO ELECTRODE DETACHMENT SHOULD BE FOUND WHEN THE DEVICE IS PUSHED IN TWO DIRECTIONS OF X AND Y WITH THE FORCE OF 5.0N FOR  $10 \pm 5$  SECONDS AFTER SOLDERING BETWEEN COPPER PLATE AND THE ELECTRODES.  
(REFER TO FIGURE AT RIGHT)
5. HEAT ENDURANCE TEST : REFER TO S-074-5002.
6. TEMPERATURE FEATURE : INDUCTANCE COEFFICIENT IS  $(0 \sim 2000) \times 10^{-6}/^{\circ}\text{C}$  ( $-25^{\circ}\text{C} \sim +85^{\circ}\text{C}$ )
7. HUMIDITY TEST : INDUCTANCE DEVIATION IS WITHIN  $\pm 5.0\%$  AND NO STRUCTURE AND ELECTRIC DEFECTS CAN BE FOUND AFTER  $96 \pm 4$  HOURS TEST UNDER THE CONDITION OF RELATIVE HUMIDITY OF  $90 \sim 95\%$  AND TEMPERATURE OF  $40 \pm 2^{\circ}\text{C}$ , AND 1 HOUR STORAGE UNDER ROOM AMBIENT CONDITIONS AFTER THE DEVICE IS WIPED WITH DRY CLOTH.
8. VIBRATION TEST : INDUCTANCE DEVIATION IS WITHIN  $\pm 3.0\%$  AFTER 1 HOUR SWEEPING VIBRATION IN EACH THREE DIRECTIONS, NAMELY, FORWARD AND BACKWARD, UP AND DOWN, RIGHT AND LEFT. THE FREQUENCY IS  $10 \sim 55 \sim 10\text{Hz}$  AND THE AMPLITUDE OF 1 MINUTE CYCLE IS 1.5mm PP.
9. SHOCK TEST : INDUCTANCE DEVIATION IS WITHIN  $\pm 3.0\%$  AFTER THE TEST WITH GUM-BLOCK SHOCK TESTING MACHINE, ONCE IN EACH OF THE THREE PERPENDICULAR AXIS DIRECTIONS. THE SHOCK ACCELERATION IS  $981\text{m/s}^2$ .

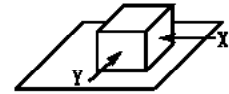

1st, Mar., 1999

CHK.	CHK.	DRG.
LIU YUEJIANG	DENG WEISHI	YANG XIANYU S

DRG. NO. 3/5

S-074-6065

# SPECIFICATION

TYPE

CDRH6D28

## ELECTRICAL CHARACTERISTICS

NO.	PART NO.	STAMP	INDUCTANCE [WITHIN] ※1	D. C. R. (Ω) [MAX.] (TYP.) (at 20°C)	RATED CURRENT (A) ※2	SUMIDA CODE
1	CDRH6D28-3R0NC	3R0	3.0 μH ± 30%	24m (18m)	3.00	4762-0005
2	CDRH6D28-3R9NC	3R9	3.9 μH ± 30%	27m (20m)	2.60	4762-0006
3	CDRH6D28-5R0NC	5R0	5.0 μH ± 30%	31m (23m)	2.40	4762-0007
4	CDRH6D28-6R0NC	6R0	6.0 μH ± 30%	35m (26m)	2.25	4762-0008
5	CDRH6D28-7R3NC	7R3	7.3 μH ± 30%	54m (40m)	2.10	4762-0009
6	CDRH6D28-8R6NC	8R6	8.6 μH ± 30%	58m (43m)	1.85	4762-0010
7	CDRH6D28-100NC	100	10 μH ± 30%	65m (48m)	1.70	4762-0011
8	CDRH6D28-120NC	120	12 μH ± 30%	70m (52m)	1.55	4762-0012
9	CDRH6D28-150NC	150	15 μH ± 30%	84m (62m)	1.40	4762-0013
10	CDRH6D28-180NC	180	18 μH ± 30%	95m (70m)	1.32	4762-0014
11	CDRH6D28-220NC	220	22 μH ± 30%	128m (95m)	1.20	4762-0015
12	CDRH6D28-270NC	270	27 μH ± 30%	142m (105m)	1.05	4762-0016
13	CDRH6D28-330NC	330	33 μH ± 30%	165m (122m)	0.97	4762-0017
14	CDRH6D28-390NC	390	39 μH ± 30%	210m (156m)	0.86	4762-0018
15	CDRH6D28-470NC	470	47 μH ± 30%	238m (176m)	0.80	4762-0019
16	CDRH6D28-560NC	560	56 μH ± 30%	277m (205m)	0.73	4762-0020
17	CDRH6D28-680NC	680	68 μH ± 30%	304m (225m)	0.65	4762-0021
18	CDRH6D28-820NC	820	82 μH ± 30%	390m (290m)	0.60	4762-0022
19	CDRH6D28-101NC	101	100 μH ± 30%	535m (397m)	0.54	4762-0023

※1 MEASURING FREQUENCY      INDUCTANCE      at 10kHz

※2 THE RATED CURRENT INDICATES THE CURRENT WHEN THE INDUCTANCE DECREASES TO 65% OF INITIAL VALUE OR DC CURRENT WHEN THE TEMPERATURE OF COIL IS INCREASED BY 30°C. THE SMALLER ONE IS DEFINED AS RATED CURRENT.

1st, Mar., 1999			SUMIDA CODE	4762
CHK.	CHK.	DRG.	DRG. NO. 4/5  S-074-6065	
LIU YUEJIANG	DENG WEISHI	YANG XIANYU S		

# SPECIFICATION

TYPE

CDRH6D28

DIMENSION RECOMMENDED (mm)

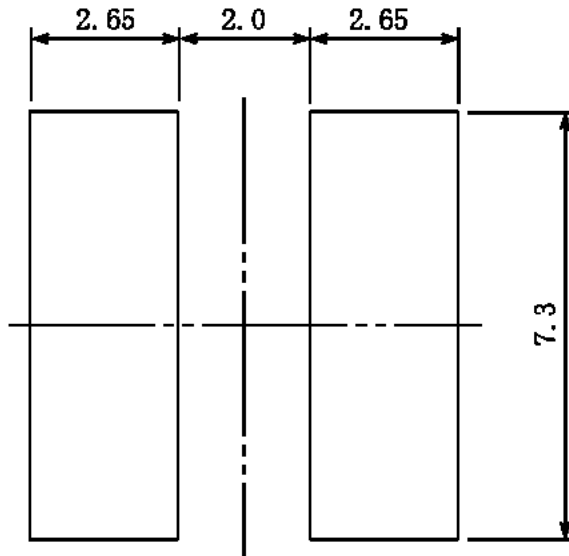

1st, Mar., 1999

CHK.	CHK.	DRG.
LIU YUEJIANG	DENG WEISHI	YANG XIANYU S

DRG. NO.

5/5

S-074-6065

## Looking for pricing, stock, or lifecycle information?

Click below to explore more details on WIN SOURCE:

- ⊖ [View CDRH6D28-220NC on WIN SOURCE](#)
- ⊖ [Sumida America Components Inc. Information](#)

## Optimize Your Supply Chain with WIN SOURCE Solutions

- ✓ Global Sourcing Solution
- ✓ Obsolete Management
- ✓ Cost Control Management
- ✓ Shortage Management
- ✓ Alternative Solution
- ✓ Excess Inventory Management