



**THE DATASHEET OF
SMB10J5.0CA-TP**



	E480232
---	----------------

Features

- Glass Passivated Chip
- 1000W Peak Pulse Power Capability with a 10/1000 us Waveform, Repetitive Rate(dutycycle):0.01%
- Low Inductance
- For Bidirectional Devices Add "C" To The Suffix of
- The Part Number: i.e.SMB10J5.0CA for 5% Tolerance
- Halogen Free. "Green" Device (Note 1)
- Moisture Sensitivity Level 1
- Epoxy Meets UL 94 V-0 Flammability Rating
- Lead Free Finish/RoHS Compliant (Note 2) ("P" Suffix Designates RoHS Compliant. See Ordering Information)

Mechanical Data

- Terminals: Solderable Per MIL-STD-750, Method 2026
- Polarity: Color Band Denotes Positive End (cathode) Except Bidirectiona

Maximum Ratings

- Operating Junction Temperature Range: -55°C to +150°C
- Storage Temperature Range: -55°C to +150°C

Electrical Characteristics @ 25°C Unless Otherwise Specified

Peak Pulse Power Surge Current on 10/1000µs Waveform	I_{PP}	See the Table	Note 3
Peak Pulse Power Dissipation	P_{PP}	1000W	Note 3
Power Dissipation on infinite heat sink	P_D	5.0W	$T_L = 75^\circ C$
Peak forward surge current	I_{FSM}	100A	Note 4
Maximum instantaneous forward voltage at 25A for unidirectional only	V_F	3.5V/5.0V	Note 5

- Notes: 1.Halogen free "Green"products are defined as those which contain <900ppm bromine, <900ppm chlorine (<1500ppm total Br + Cl) and <1000ppm antimony compounds.
 2.High Temperature Solder Exemption Applied, see EU Directive Annex 7a.
 3.Non-repetitive current pulse, per Fig.3 and derated above $T_A=25^\circ C$ per Fig.4
 4.Measured on 8.3 ms single half sine-wave or equivalent square wave, duty cycle =4 pulses per minute maximum.
 5. $V_F < 3.5V$ for devices of $V_{BR} < 50V$.

Pin Configuration:

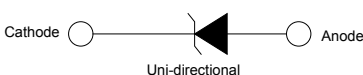

1000 Watt TVS 5.0 to 120 Volts

SMB (DO-214AA) (LEAD FRAME)

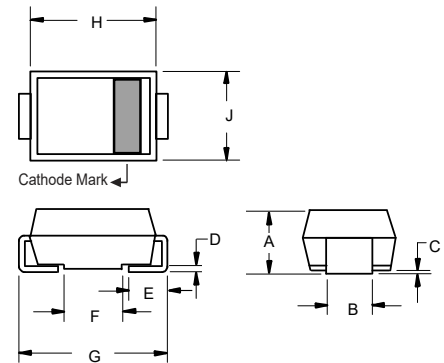

DIM	INCHES		MM		NOTE
	MIN	MAX	MIN	MAX	
A	0.079	0.103	2.00	2.62	
B	0.075	0.087	1.91	2.21	
C	0.002	0.008	0.05	0.20	
D	0.006	0.012	0.15	0.31	
E	0.030	0.060	0.76	1.52	
F	0.065	0.091	1.65	2.32	
G	0.200	0.220	5.08	5.59	
H	0.160	0.191	4.06	4.85	
J	0.130	0.155	3.30	3.94	

Suggested Solder Pad Layout

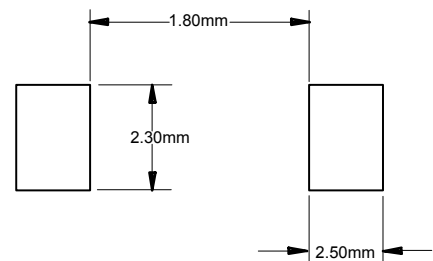

Electrical Characteristics @ 25°C Unless Otherwise Specified

MCC Part Number		Breakdown Voltage V_{BR} @ I_T			Maximum Reverse Leakage I_R @ V_{RWM} (μA)	Working Peak Reverse Voltage V_{RWM} (V)	Maximum Reverse Surge Current I_{PP} (A)	Maximum Clamping Voltage V_C @ I_{PP} (V)	Device Marking Code	
Uni	Bi	Min (V)	Max (V)	I_T (mA)					Uni	Bi
SMB10J5.0A	SMB10J5.0CA	6.40	7.00	10	800	5.0	108.70	9.2	AKE	AAE
SMB10J6.0A	SMB10J6.0CA	6.67	7.37	10	800	6.0	97.09	10.3	AKG	AAG
SMB10J6.5A	SMB10J6.5CA	7.22	7.98	10	500	6.5	89.29	11.2	AKK	AAK
SMB10J7.0A	SMB10J7.0CA	7.78	8.60	10	200	7.0	83.33	12.0	AKM	AAM
SMB10J7.5A	SMB10J7.5CA	8.33	9.21	1	100	7.5	77.52	12.9	AKP	AAP
SMB10J8.0A	SMB10J8.0CA	8.89	9.83	1	50	8.0	73.53	13.6	AKR	AAR
SMB10J8.5A	SMB10J8.5CA	9.44	10.40	1	10	8.5	69.44	14.4	AKT	AAT
SMB10J9.0A	SMB10J9.0CA	10.00	11.10	1	5.0	9.0	64.94	15.4	AKV	AAV
SMB10J10A	SMB10J10CA	11.10	12.30	1	5.0	10.0	58.82	17.0	AKX	AAX
SMB10J11A	SMB10J11CA	12.20	13.50	1	5.0	11.0	54.95	18.2	AKZ	AAZ
SMB10J12A	SMB10J12CA	13.30	14.70	1	5.0	12.0	50.25	19.9	ALE	ABE
SMB10J13A	SMB10J13CA	14.40	15.90	1	1.0	13.0	46.51	21.5	ALG	ABG
SMB10J14A	SMB10J14CA	15.60	17.20	1	1.0	14.0	43.10	23.2	ALK	ABK
SMB10J15A	SMB10J15CA	16.70	18.50	1	1.0	15.0	40.98	24.4	ALM	ABM
SMB10J16A	SMB10J16CA	17.80	19.70	1	1.0	16.0	38.46	26.0	ALP	ABP
SMB10J17A	SMB10J17CA	18.90	20.90	1	1.0	17.0	36.23	27.6	ALR	ABR
SMB10J18A	SMB10J18CA	20.00	22.10	1	1.0	18.0	34.25	29.2	ALT	ABT
SMB10J19A	SMB10J19CA	21.10	23.30	1	1.0	19.0	32.49	30.8	ALB	ABB
SMB10J20A	SMB10J20CA	22.20	24.50	1	1.0	20.0	30.86	32.4	ALV	ABV
SMB10J22A	SMB10J22CA	24.40	26.90	1	1.0	22.0	28.17	35.5	ALX	ABX
SMB10J24A	SMB10J24CA	26.70	29.50	1	1.0	24.0	25.71	38.9	ALZ	ABZ
SMB10J26A	SMB10J26CA	28.90	31.90	1	1.0	26.0	23.75	42.1	AME	ACE
SMB10J28A	SMB10J28CA	31.10	34.40	1	1.0	28.0	22.03	45.4	AMG	ACG
SMB10J30A	SMB10J30CA	33.30	36.80	1	1.0	30.0	20.66	48.4	AMK	ACK
SMB10J33A	SMB10J33CA	36.70	40.60	1	1.0	33.0	18.76	53.3	AMM	ACM
SMB10J36A	SMB10J36CA	40.00	44.20	1	1.0	36.0	17.21	58.1	AMP	ACP
SMB10J40A	SMB10J40CA	44.40	49.10	1	1.0	40.0	15.50	64.5	AMR	ACR
SMB10J43A	SMB10J43CA	47.80	52.80	1	1.0	43.0	14.41	69.4	AMT	ACT
SMB10J45A	SMB10J45CA	50.00	55.30	1	1.0	45.0	13.76	72.7	AMV	ACV
SMB10J48A	SMB10J48CA	53.30	58.90	1	1.0	48.0	12.92	77.4	AMX	ACX
SMB10J51A	SMB10J51CA	56.70	62.70	1	1.0	51.0	12.14	82.4	AMZ	ACZ
SMB10J54A	SMB10J54CA	60.00	66.30	1	1.0	54.0	11.48	87.1	ANE	ADE
SMB10J58A	SMB10J58CA	64.40	71.20	1	1.0	58.0	10.68	93.6	ANG	ADG
SMB10J60A	SMB10J60CA	66.70	73.70	1	1.0	60.0	10.33	96.8	ANK	ADK
SMB10J64A	SMB10J64CA	71.10	78.60	1	1.0	64.0	9.71	103.0	ANM	ADM
SMB10J70A	SMB10J70CA	77.80	86.00	1	1.0	70.0	8.85	113.0	ANP	ADP
SMB10J75A	SMB10J75CA	83.30	92.10	1	1.0	75.0	8.26	121.0	ANR	ADR
SMB10J78A	SMB10J78CA	86.70	95.80	1	1.0	78.0	7.94	126.0	ANT	ADT
SMB10J80A	SMB10J80CA	88.80	97.60	1	1.0	80.0	7.72	129.6	ANB	ADB
SMB10J85A	SMB10J85CA	94.40	104.00	1	1.0	85.0	7.30	137.0	ANV	ADV
SMB10J90A	SMB10J90CA	100.00	111.00	1	1.0	90.0	6.85	146.0	ANX	ADX
SMB10J100A	SMB10J100CA	111.00	123.00	1	1.0	100.0	6.17	162.0	ANZ	ADZ
SMB10J110A	SMB10J110CA	122.00	135.00	1	1.0	110.0	5.65	177.0	APE	AEE
SMB10J120A	SMB10J120CA	133.00	147.00	1	1.0	120.0	5.18	193.0	APG	AEG

1. Add suffix ' CA ' after part number to specify Bi-directional devices
2. For Bi-Directional devices having V_R of 10 volts and under, the I_R limit is double

Curve Characteristics

Fig. 1 - Peak Pulse Power Rating Curve

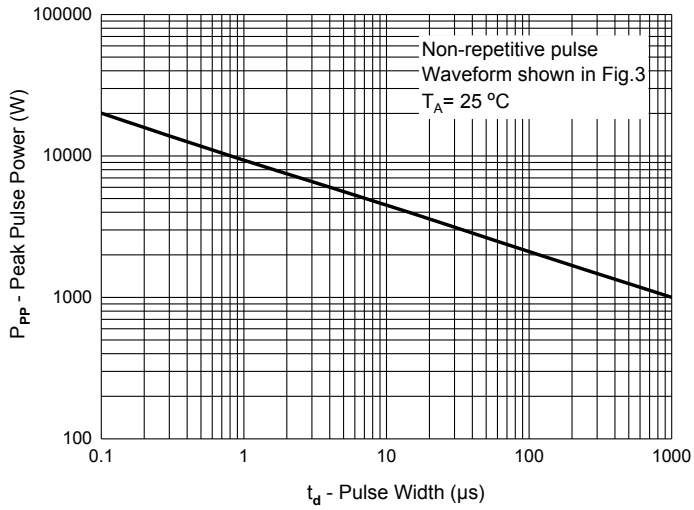

Fig. 2 - Typical Junction Capacitance

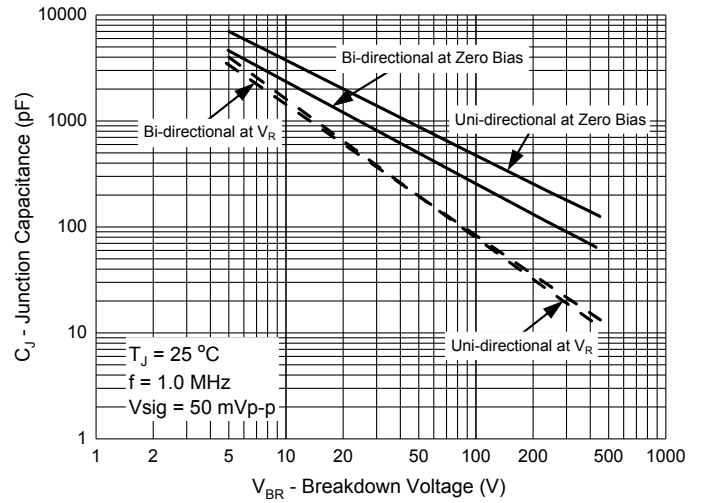

Fig. 3 - Pulse Waveform

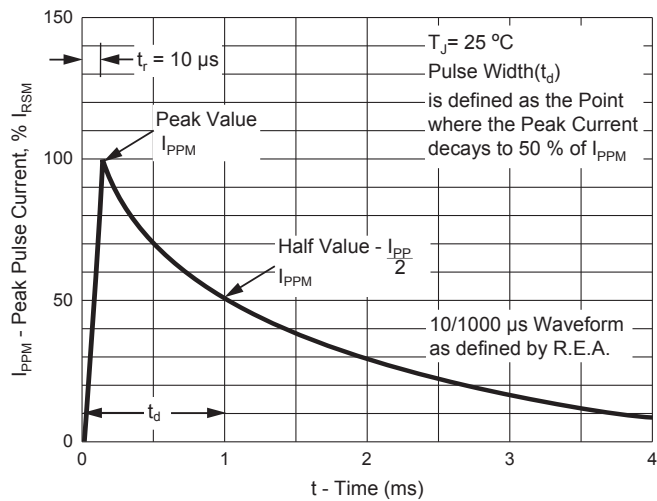
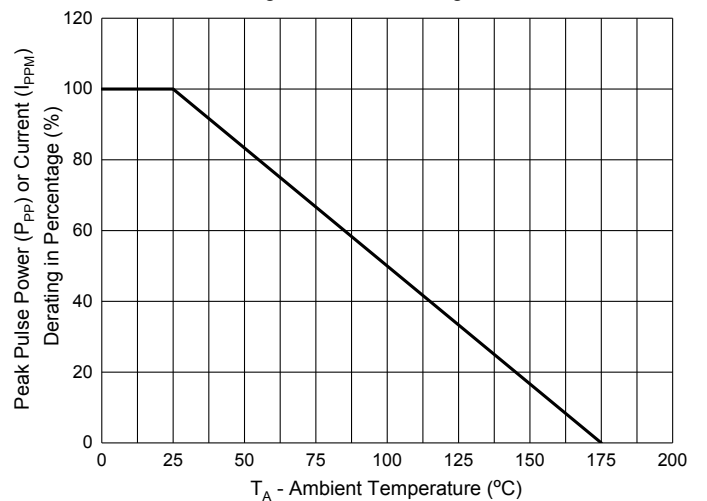

Fig. 4 - Pulse Derating Curve



Ordering Information

Device	Packing
Part Number-TP	Tape&Reel:3Kpcs/Reel

IMPORTANT NOTICE

Micro Commercial Components Corp. reserves the right to make changes without further notice to any product herein to make corrections, modifications, enhancements, improvements, or other changes. **Micro Commercial Components Corp.** does not assume any liability arising out of the application or use of any product described herein; neither does it convey any license under its patent rights, nor the rights of others. The user of products in such applications shall assume all risks of such use and will agree to hold **Micro Commercial Components Corp.** and all the companies whose products are represented on our website, harmless against all damages. **Micro Commercial Components Corp.** products are sold subject to the general terms and conditions of commercial sale, as published at <https://www.mccsemi.com/Home/TermsAndConditions>.

LIFE SUPPORT

MCC's products are not authorized for use as critical components in life support devices or systems without the express written approval of Micro Commercial Components Corporation.

CUSTOMER AWARENESS

Counterfeiting of semiconductor parts is a growing problem in the industry. Micro Commercial Components (MCC) is taking strong measures to protect ourselves and our customers from the proliferation of counterfeit parts. MCC strongly encourages customers to purchase MCC parts either directly from MCC or from Authorized MCC Distributors who are listed by country on our web page cited below. Products customers buy either from MCC directly or from Authorized MCC Distributors are genuine parts, have full traceability, meet MCC's quality standards for handling and storage. **MCC will not provide any warranty coverage or other assistance for parts bought from Unauthorized Sources.** MCC is committed to combat this global problem and encourage our customers to do their part in stopping this practice by buying direct or from authorized distributors.

Looking for pricing, stock, or lifecycle information?

Click below to explore more details on WIN SOURCE:

- ⊖ [View SMB10J5.0CA-TP](#) on WIN SOURCE
- ⊖ [Micro Commercial Co](#) Information

Optimize Your Supply Chain with WIN SOURCE Solutions

- ✓ Global Sourcing Solution
- ✓ Obsolete Management
- ✓ Cost Control Management
- ✓ Shortage Management
- ✓ Alternative Solution
- ✓ Excess Inventory Management