



THE DATASHEET OF CDRH5D18NP-4R1NC



Type: CDRH5D18, CDRH5D18B/HP
◆ Product Description

- 6.0×6.0mm Max.(L×W)(CDRH5D18), 6.3×6.2mm Max.(L×W)(CDRH5D18B/HP) 2.0mm Max. Height.
- Inductance Range: 4.1~100 μ H(CDRH5D18), 0.6~5.0 μ H(CDRH5D18B/HP).
- Rated current range: 0.36~1.95A(CDRH5D18), 1.7~4.4A(CDRH5D18B/HP).
- In addition to the standard versions of inductors shown here, custom inductors are available to meet your exact requirements.

◆ Feature

- Magnetically shielded construction.
- Ideally used in Mobile phone, MP3, PDA, HDD, DSC/DVC, Game machine, etc as DC-DC Converter inductors.
- RoHS Compliance

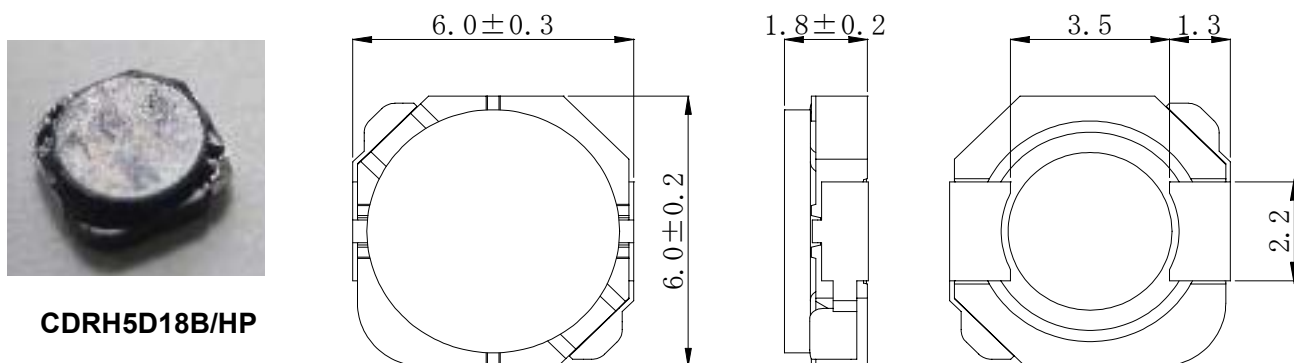
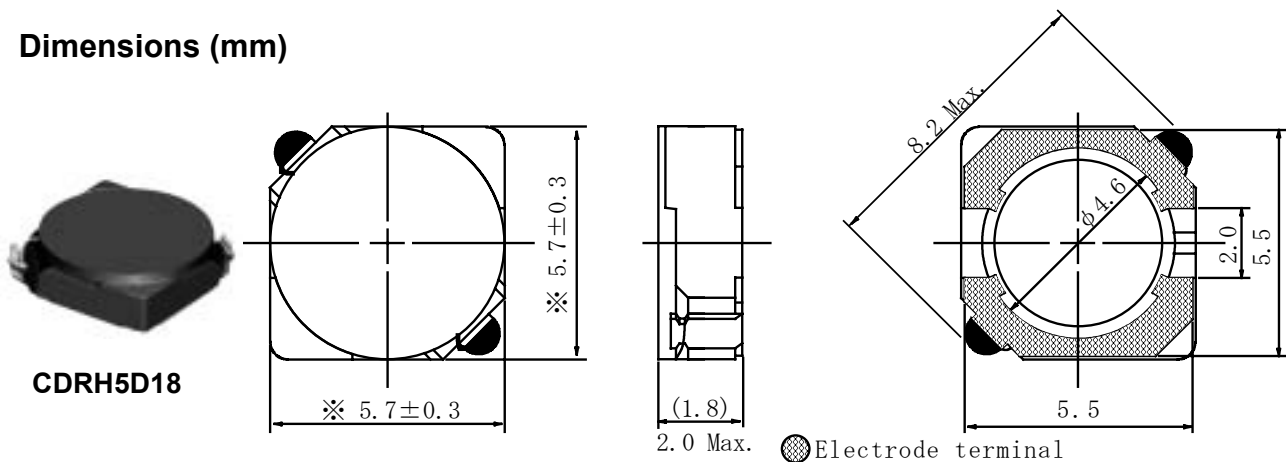
◆ Dimensions (mm)

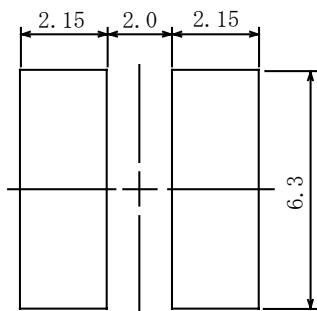
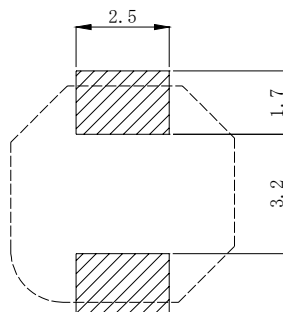
Type: CDRH5D18, CDRH5D18B/HP
◆ Land Pattern (mm)

CDRH5D18

CDRH5D18B/HP
◆ Specification(CDRH5D18)

Part Name ※	Stamp	Inductance(μ H) [Within] 100kHz/1V	D.C.R. (Ω) [Max.] (Typ.) (at 20°C)	Rated current (A) ※1
CDRH5D18NP-4R1N□	4R1	4.1 \pm 30%	57m (42m)	1.95
CDRH5D18NP-5R4N□	5R4	5.4 \pm 30%	76m (56m)	1.60
CDRH5D18NP-6R2N□	6R2	6.2 \pm 30%	96m (71m)	1.40
CDRH5D18NP-8R9N□	8R9	8.9 \pm 30%	116m (86m)	1.25
CDRH5D18NP-10 \emptyset N□	100	10 \pm 30%	124m (92m)	1.20
CDRH5D18NP-12 \emptyset N□	120	12 \pm 30%	153m (113m)	1.10
CDRH5D18NP-15 \emptyset N□	150	15 \pm 30%	196m (145m)	0.97
CDRH5D18NP-18 \emptyset N□	180	18 \pm 30%	210m (155m)	0.85
CDRH5D18NP-22 \emptyset N□	220	22 \pm 30%	290m (215m)	0.80
CDRH5D18NP-27 \emptyset N□	270	27 \pm 30%	330m (245m)	0.75
CDRH5D18NP-33 \emptyset N□	330	33 \pm 30%	385m (285m)	0.65
CDRH5D18NP-39 \emptyset N□	390	39 \pm 30%	520m (385m)	0.57
CDRH5D18NP-47 \emptyset N□	470	47 \pm 30%	595m (440m)	0.54
CDRH5D18NP-56 \emptyset N□	560	56 \pm 30%	665m (493m)	0.50
CDRH5D18NP-68 \emptyset N□	680	68 \pm 30%	840m (622m)	0.43
CDRH5D18NP-82 \emptyset N□	820	82 \pm 30%	978m (725m)	0.41
CDRH5D18NP-101N□	101	100 \pm 30%	1.2 (895m)	0.36

Type: CDRH5D18, CDRH5D18B/HP
◆ Specification(CDRH5D18B/HP)

Part Name ※	Stamp	Inductance (μ H) [Within] 100kHz/1V	D.C.R.(m Ω) Max.(Typ.) (at 20°C)	Saturation Current (A) ※1-2		Temperature rise current (A)※2
				(at20°C)	(at100°C)	
CDRH5D18BHPNP-ØR6M□	0R6	0.6±20%	25 (19)	8.2	6.8	4.4
CDRH5D18BHPNP-1RØM□	1R0	1.0±20%	31 (24)	6.6	5.6	3.7
CDRH5D18BHPNP-1R5M□	1R5	1.5±20%	38 (29)	5.3	4.6	2.8
CDRH5D18BHPNP-1R8M□	1R8	1.8±20%	46 (35)	5.0	4.1	2.5
CDRH5D18BHPNP-2R7M□	2R7	2.7±20%	65 (50)	3.9	3.3	2.3
CDRH5D18BHPNP-3R3M□	3R3	3.3±20%	78 (60)	3.4	2.9	2.0
CDRH5D18BHPNP-4R2M□	4R2	4.2±20%	98 (75)	3.1	2.5	1.8
CDRH5D18BHPNP-5RØM□	5R0	5.0±20%	109 (84)	2.7	2.4	1.7

※ Description of part name

CDRH5D18BHPNP-ØR6M□

- B Box
- C Carrier Tape

※1-1. Rated current: The DC current at which the inductance decreases to 65 % of its nominal value or when $\Delta t=30^{\circ}\text{C}$, whichever is lower($T_a=20^{\circ}\text{C}$).

※1-2. Saturation current: The DC current at which the inductance decreases to 65% of its nominal value.

※2. Temperature rise current: The DC current at which the temperature rise is $\Delta t=40^{\circ}\text{C}$.($T_a=20^{\circ}\text{C}$).

Looking for pricing, stock, or lifecycle information?

Click below to explore more details on WIN SOURCE:

- ⊖ [View CDRH5D18NP-4R1NC on WIN SOURCE](#)
- ⊖ [Sumida America Components Inc. Information](#)

Optimize Your Supply Chain with WIN SOURCE Solutions

- ✓ Global Sourcing Solution
- ✓ Obsolete Management
- ✓ Cost Control Management
- ✓ Shortage Management
- ✓ Alternative Solution
- ✓ Excess Inventory Management