



**THE DATASHEET OF
SI-CU5523001WW**



LED Driver

Indoor 30w Compact Driver

Non-Dimming : SI-CU55230N1WW

Dimming : SI-CU5523001WW



Constant Current LED Driver

Features & Benefits

- Output Current Range: 0.275~0.555 A (adjustable via R-set)
- Output Voltage Range: MAX 54 Vdc
- Output Power Range: Max 30 W
- Dimming Control: 0-10 V (Min. 3.5%)
- Input Voltage: 120 ~ 277 Vac, 50/60 Hz
- Safety: UL / cUL (UL 8750, UL Class 2)
- EMI: FCC Part 15 Class B
- Protections: Short Circuit, Over Voltage (Auto Recovery)
- t_a Range: -20 ~ +50 °C
- Expected lifetime: 50,000 hours at $t_c < 65$ °C
- Long lasting & high reliability
- Metal housing



Applications

- Indoor lighting

Table of Contents

1.	Characteristics	-----	3
2.	Typical Characteristics Graphs	-----	5
3.	Protection	-----	6
4.	Dimming Specification	-----	6
5.	Reliability & standard	-----	7
6.	Outline Drawing & Dimension	-----	8
7.	Label Structure	-----	8
8.	Packing Structure	-----	9
9.	Precautions in Handling & Use	-----	10

1. Characteristics

Article	Symbol	Specification			Unit	Note
		Min.	Typ.	Max.		
INPUT SPECIFICATIONS						
Nominal Voltage	Vin	120		277	Vac	
Voltage Range		108		300	Vac	
Nominal Frequency	Fin		50 / 60		Hz	
Frequency Range		47		63	Hz	
Input Current	At 120 Vac	lin		0.35	A	At full load
	At 277 Vac	lin		0.15	A	At full load
Total Harmonic Distortion	THD			20	%	At 120-277 Vac
Power Factor	PF	0.9			-	At 120-277 Vac
Efficiency		86	87		%	At full load, 120 Vac, 60 Hz At full load, 277 Vac, 60 Hz
		86	88			
In-rush Current				30	Apk	NEMA410.
OUTPUT SPECIFICATIONS						
Voltage Range	Vo	37		54	Vdc	70% of MAX power can meet PF,THD
Max. Voltage				60	Vdc	Open circuit, No-load protection
Current Range	Io	0.275		0.555	A	70% of MAX power can meet PF,THD
Line Regulation		-3		3	%	@120~277Vac
Load Regulation		-5		5	%	@120~277Vac, W/O dimming
Current Tolerance		-5		5	%	@120~277Vac, W/O dimming
Ripple Current				50%	%	$\frac{1}{I_{avg}}(I_{peak} - I_{avg}) \times 100\%$
Peak current				150%		$\frac{I_{peak}}{I_{avg}} \times 100\%$
Nominal Power	Po			30	W	
Turn-on Delay Time	Td			1	s	@120Vac, W/O dimmer

1) PF, THD, FCC can meet the electrical performance from 70% of MAX power.

2) Measured the unit is thermally stabilized after half an hour, Ta 25°C.

Article	Symbol	Specification			Unit	Note
		Min.	Typ.	Max.		
DIMMING SPECIFICATIONS		3.5		100	%	@555mA
Dimming Control			0-10 V			See Dimming Specification section
ENVIRONMENTAL SPECIFICATIONS						
Ambient Temperature	ta	-20		50	°C	
Case Temperature	tc			75	°C	Type TL 75 °C / 65 °C
Storage Temperature	ts	-40		85	°C	
Ambient Humidity		10		90	%	Not condensing
Surge Transient Protection	L / N			±2.5	kV	ANSI/IEEE C62.41 100KHz Ring Wave
	LN / GND			±2.5	kV	
IP Rating			20		-	Suitable for indoor environment
Expected Lifetime (e-cap)		50,000			h	At tc < 65 °C, full load, 120-277 Vac
MTBF		500,000			h	Ta=25°C, Telcordia SR-332, Method I
Dimensions	L x W x H		165 x 43 x 32		mm	
Net Weight			195		g	

2. Typical Characteristics Graphs

a) Operating Window

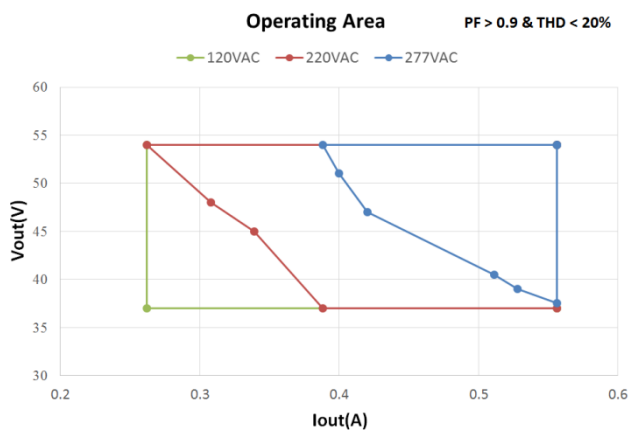

b) Efficiency vs. Load

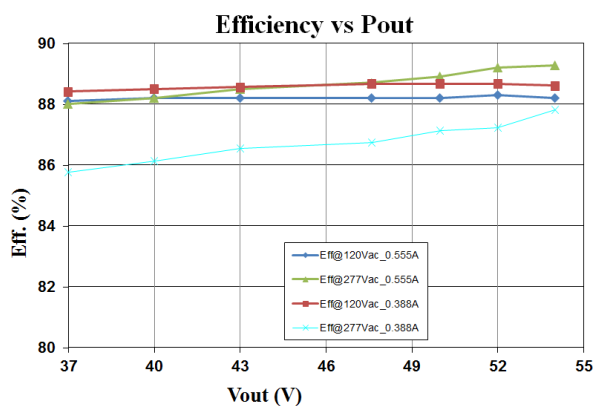

c) Power Factor vs. Load

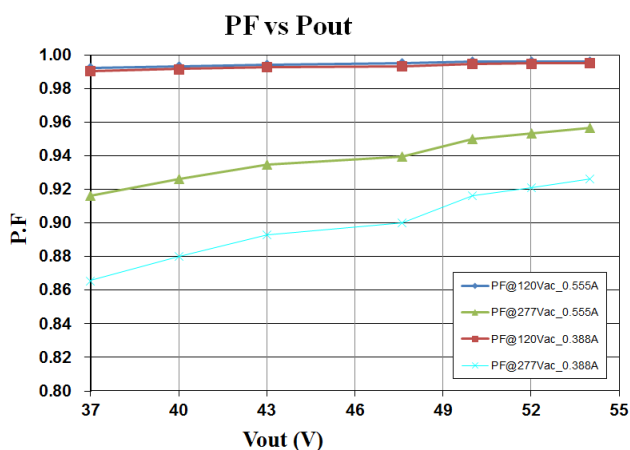

d) Total Harmonic Distortion vs. Load

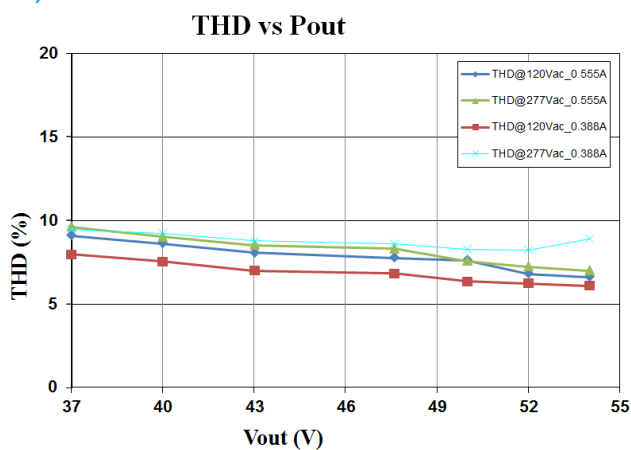

e) Life time

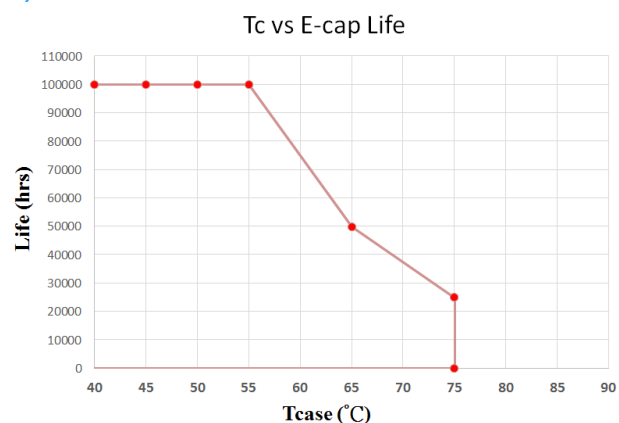

f) Ta vs. Load

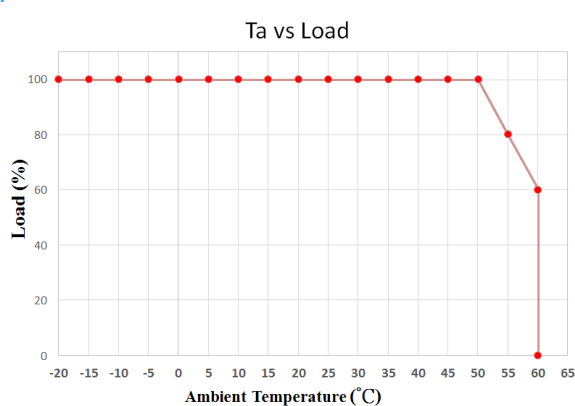

g) R-set Table

Rset (Kohm)	Iout(A)	Iout(%)
0.00	0.2689	48.5
0.10	0.2737	49.3
0.33	0.2841	51.2
0.68	0.2985	53.8
1.05	0.3122	56.2
1.43	0.3248	58.5
1.87	0.3378	60.9
2.00	0.3414	61.5
2.32	0.3497	63.0
2.87	0.3625	65.3
3.48	0.3750	67.6
3.83	0.3815	68.7
4.22	0.3882	69.9
4.99	0.3999	72.1
5.62	0.4084	73.6
6.49	0.4187	75.4
7.15	0.4255	76.7
7.68	0.4306	77.6
8.87	0.4406	79.4
10.00	0.4487	80.8
10.50	0.4519	81.4
12.40	0.4625	83.3
14.30	0.4712	84.9
16.90	0.4807	86.6
20.00	0.4895	88.2
24.90	0.4998	90.1
30.10	0.5077	91.5
39.20	0.5171	93.2
53.60	0.5261	94.8
76.80	0.5341	96.2
100.00	0.5385	97.0
130.00	0.5420	97.7
205.00	0.5464	98.4
Open	0.5550	100.0

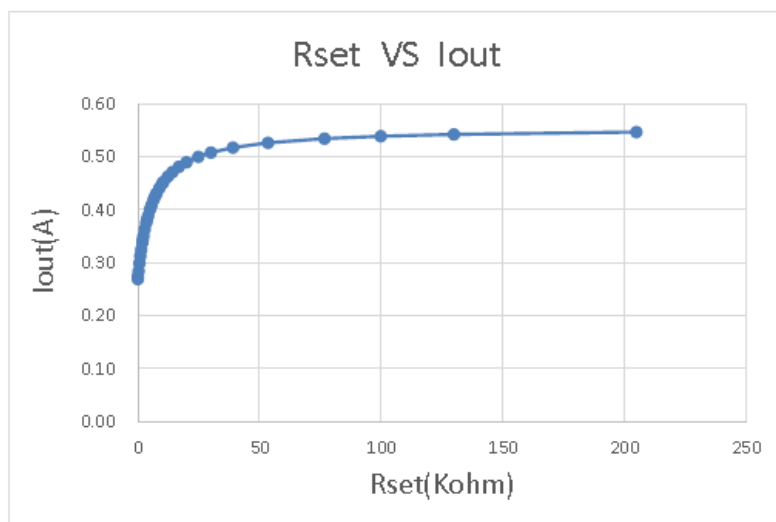

3. Protection

a) Output Short Circuit Protection

The unit is protected when output is short thus avoiding safety hazard, shock hazard and damage to the unit. After the short circuit fault condition is removed, the unit will enter the auto-recovery mode.

b) Output Over Voltage Protection (Output Open Load Protection)

When no load condition occurs, the unit will clamp output voltage to the OVP Voltage avoiding damage to the unit. After the load is connected, the unit will enter the auto-recovery mode.

The OVP Voltage varies according to the Rset resistor value (see below curve and table) and under 60 V.

4. Diming Specification

1) Control Type : 0-10V

The unit has Analog Dimming (AD) function, using 0-10 Vdc. The typical dimming curve is shown below. The dimming curve is tested with LED electronic load Chroma 63115A/6312A. Rd coefficient is 0.1.

	Symbol	Unit	Min	Typ	Max	Remark
Dimming	Range	V	0		10	
	Dim off	V	0		0.5	Hysteresis to Dim > 0.8V
	Dim. Min.	V	0.6	1	1.6	
	Dim Max.	V	9.2		10	

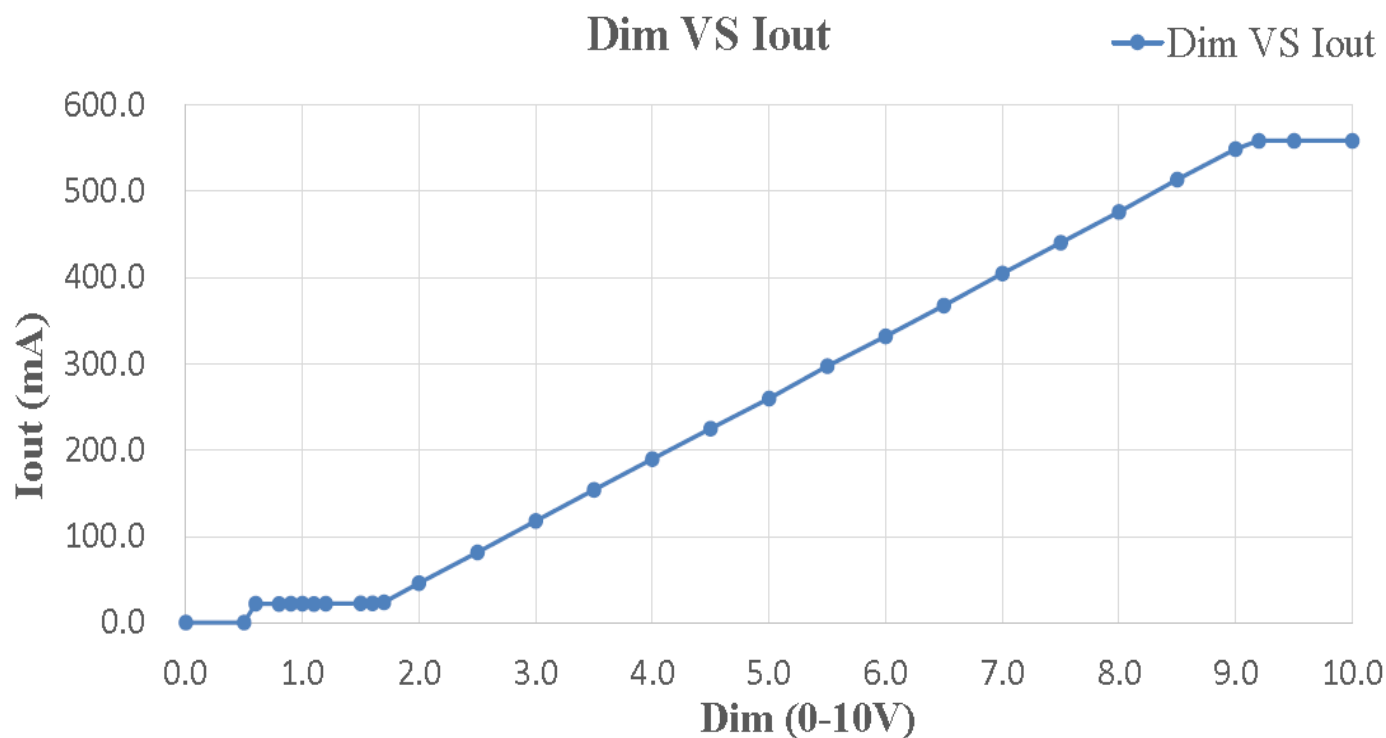

5. Reliability & Standards

Test Items and Conditions

Test Item		Specification	Condition
Leakage Current		< 0.7 mA	305Vac, IEC 60598-1
Earth Continuity		< 0.5 Ω	IEC 61347-2-13
Hi-Pot	Input – Output	3750 Vac, 60 s, cut-off current 10 mA	100 % tested in production line
	Input – F.G	1857 Vac, 60 s, cut-off current 10 mA	100 % tested in production line
	Output – F.G	1500 Vac, 60 s, cut-off current 10 mA	100 % tested in production line
Insulation Resistance	Input – Output	500 Vdc, 60 s, insulation resistance 10 M Ω	100 % tested in production line
Surge	L / N	± 2.5 kV	ANSI/IEEE C62.41 100KHz Ring Wave
	L-N / GND	± 2.5 kV	
ESD	Contact	± 4 kV	EN61547(IEC 61000-4-2)
	Air	± 8 kV	

Safety, EMI and EMC

International Standard	Certification
UL Safety Standards (Class 2 Output)	UL8750
EMC	Comply with FCC Part 15 Class B
Harmonic current emissions: Class C	Comply with IEC/EN 61000-3-2
Electrostatic Discharge (ESD): Contact 4kV, Air 8kV	Comply with IEC/EN 61000-4-2
Radio-frequency Electromagnetic Fields	Comply with IEC/EN 61000-4-3
Electrical Fast Transients (EFT)	Comply with IEC/EN 61000-4-4
Surges: Differential 1kV, Common 2kV	Comply with IEC/EN 61000-4-5
Injected Currents, Conducted disturbances induced by Radio-Frequency fields	Comply with IEC/EN 61000-4-6
Voltage Dips and Short Interruptions (Class B)	Comply with IEC/EN 61000-4-11

6. Outline Drawing & Dimension

Dimension : 165 (L) x 43 (W) x 32 (H) Unit: mm

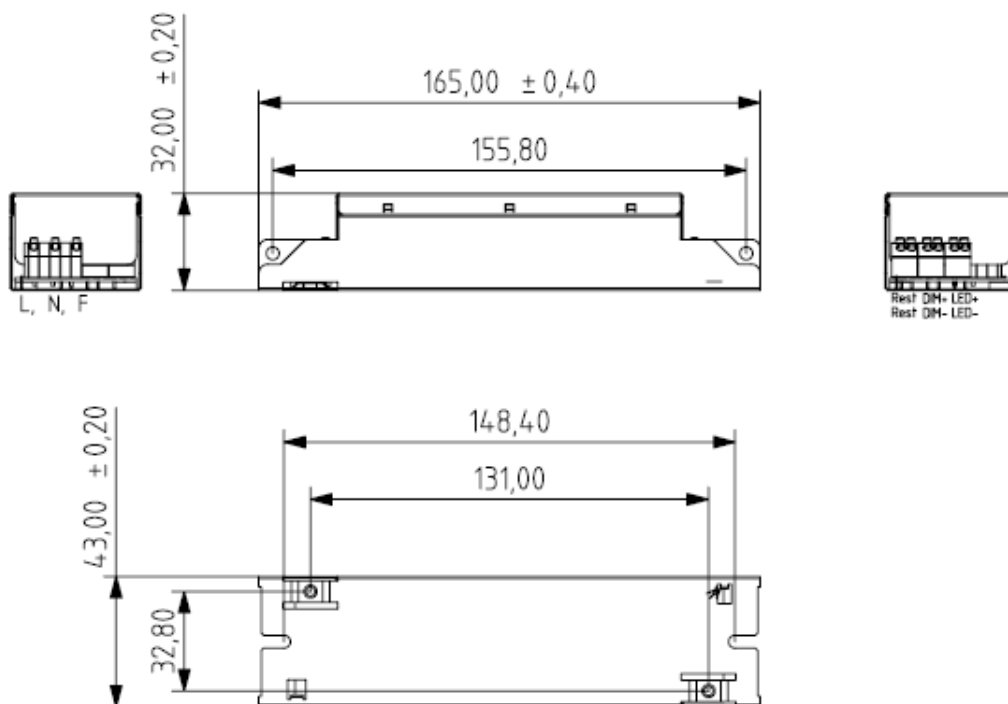

7. Label Structure

L 0.75 ~ 1.25 □ N 	LED POWER SUPPLY		tc : 75°C Type TL 75/65°C	LED+ LED- AD+ AD- Rset Rset	
	MODEL: SI-CU5523001WW				E470825
	P/N: SX030G001LD				
	INPUT : 120 – 277V ~ 0.35A 50/60Hz				
OUTPUT : 37 – 54V/0.555A 30W max	9mm wire preparation				
CONSTANT CURRENT , SELV	0.5 ~ 1.25mm ² /AWG 16 - 20				
POWER FACTOR (PF) : > 0.9					
DIMMER INTERFACE : 0 – 10V					
TA : 50°C					
MADE in China					
Class 2 Power Unit Ver.1.1					

0-10 Dimming

L 0.75 ~ 1.25 □ N 	LED POWER SUPPLY		tc : 75°C Type TL 75/65°C	LED+ LED- Rset Rset	
	MODEL: SI-CU55230N1WW				E470825
	P/N: SX030G001ND				
	INPUT : 120 – 277V ~ 0.35A 50/60Hz				
OUTPUT: 37 – 54V/0.555A 30W max	9mm wire preparation				
CONSTANT CURRENT , SELV	0.5 ~ 1.25mm ² /AWG 16 - 20				
POWER FACTOR (PF) : > 0.9					
TA : 50°C					
MADE in China					
Class 2 Power Unit Ver.1.1					

Non- Dimming

8. Packing Structure

Packing material	Max. quantity (pcs)	Dimension (mm)		
		Length	Width	Height
Outer Box	24	400	300	170
Pallet	960 (40 outer boxes)	1,200	1,000	1110

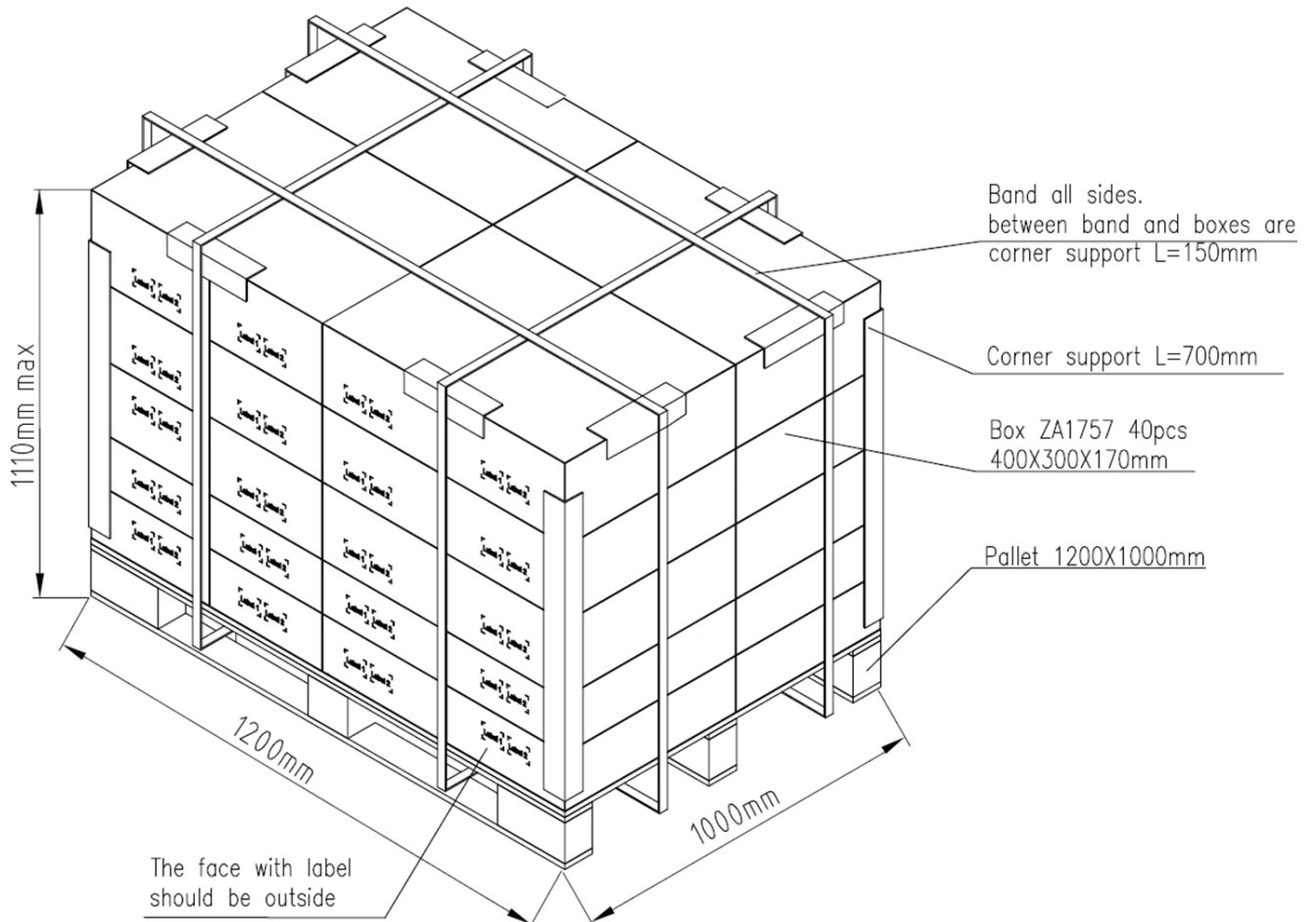

9. Precautions in Handling & Use

- 1) To prevent the LED Driver from any defect, please handle and store it with care
 - Do not drop or give shock
 - Do not store in very humid location or at extreme temperature
 - Do not open or disassemble the product
- 2) Static electricity or surge voltage may damage the components inside LED Driver, as such please observe proper anti-electrostatic working process
 - People handling the Driver should be well grounded (e.g. using ESD wrist band) and wear anti-static working clothes and gloves
 - All related devices and instruments in the production line should be well grounded (e.g. working table, measuring equipment, assembly jigs)
- 3) Observe the correct polarity of output terminal
- 4) Avoid input voltage exceeds the maximum rating, which will cause damage to the circuit and result in malfunction

Legal and additional information.

[About Samsung Electronics Co., Ltd.](#)

Samsung Electronics Co., Ltd. inspires the world and shapes the future with transformative ideas and technologies, redefining the worlds of TVs, smartphones, wearable devices, tablets, cameras, digital appliances, printers, medical equipment, network systems and semiconductors.

We are also leading in the Internet of Things space through, among others, our Digital Health and Smart Home initiatives. We employ 307,000 people across 84 countries. To discover more, please visit our official website at www.samsung.com and our official blog at global.samsungtomorrow.com.

Copyright © 2015 Samsung Electronics Co., Ltd. All rights reserved.

Samsung is a registered trademark of Samsung Electronics Co., Ltd.

Specifications and designs are subject to change without notice. Non-metric weights and measurements are approximate. All data were deemed correct at time of creation. Samsung is not liable for errors or omissions. All brand, product, service names and logos are trademarks and/or registered trademarks of their respective owners and are hereby recognized and acknowledged.

Samsung Electronics Co., Ltd.

95, Samsung 2-ro

Giheung-gu

Yongin-si, Gyeonggi-do, 446-711

KOREA

www.samsungled.com



Looking for pricing, stock, or lifecycle information?

Click below to explore more details on WIN SOURCE:

- ⊖ [View SI-CU5523001WW](#) on WIN SOURCE
- ⊖ [Samsung](#) Information

Optimize Your Supply Chain with WIN SOURCE Solutions

- ✓ Global Sourcing Solution
- ✓ Obsolete Management
- ✓ Cost Control Management
- ✓ Shortage Management
- ✓ Alternative Solution
- ✓ Excess Inventory Management