

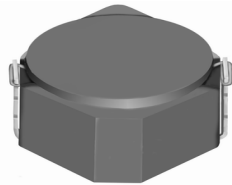

THE DATASHEET OF CDRH3D23NP-1R0PC



SMD Power Inductor CDRH3D23



Description

- Ferrite drum core construction.
- Magnetically shielded.
- L × W × H: 3.92 × 3.92 × 2.5 mm Max.
- Product weight: 112mg(Ref.)
- Moisture Sensitivity Level: 1
- RoHS compliance.

Environmental Data

- Operating temperature range: -40°C~+105°C (including coil's self temperature rise)
- Storage temperature range: -40°C~+105°C
- Solder reflow temperature: 260 °C peak.

Packaging

- Carrier tape and reel packaging
- 7.0" diameter reel
- 500pcs per reel

Applications

- Ideally used in Mobilephone, PDA, MP3, DSC/DVC, etc as DC-DC converter inductors.

Dimension - [mm]

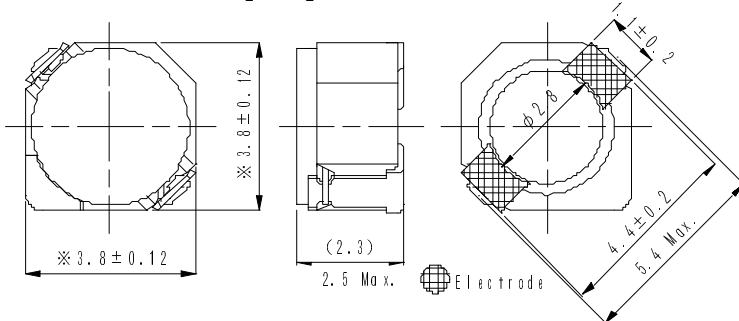

Land pattern and Schematics - [mm]

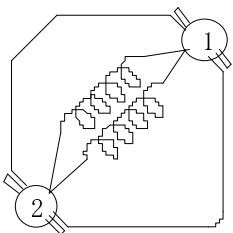
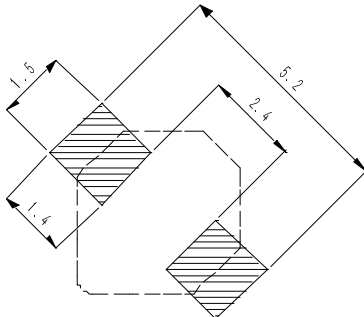

(0.47 μ H ~ 10.0 μ H)

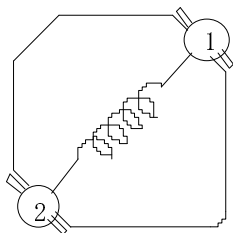

(15.0 μ H ~ 47.0 μ H)

SMD Power Inductor CDRH3D23



Electrical Characteristics

Part Name	Stamp	Inductance (μ H) [within] ※1	D.C.R. (m Ω) Max. (Typ.) (at 20°C)	Saturation Current (A) ※2		Temperature Rise Current (A) ※3
				at 20°C	at 105°C	
CDRH3D23NP-R47NC	A	0.47 \pm 30%	23.5(18.8)	3.10	2.40	3.30
CDRH3D23NP-1R0PC	A	1.0 \pm 25%	25.0(20)	2.80	2.00	3.10
CDRH3D23NP-1R5PC	B	1.5 \pm 25%	29.0(24)	2.20	1.65	2.90
CDRH3D23NP-2R2PC	C	2.2 \pm 25%	38.3(31)	1.80	1.30	2.50
CDRH3D23NP-3R3PC	D	3.3 \pm 25%	56.3(45)	1.45	1.10	2.20
CDRH3D23NP-4R7PC	E	4.7 \pm 25%	68.8(55)	1.30	0.95	1.90
CDRH3D23NP-5R6PC	F	5.6 \pm 25%	75.0(60)	1.10	0.80	1.80
CDRH3D23NP-6R8PC	G	6.8 \pm 25%	87.8(72)	1.00	0.75	1.70
CDRH3D23NP-8R2PC	H	8.2 \pm 25%	94.8(77)	0.95	0.70	1.60
CDRH3D23NP-100MC	I	10.0 \pm 20%	117(95)	0.85	0.60	1.40
CDRH3D23NP-150MC	J	15.0 \pm 20%	191(154)	0.70	0.50	0.85
CDRH3D23NP-220MC	K	22.0 \pm 20%	270(219)	0.55	0.40	0.75
CDRH3D23NP-330MC	L	33.0 \pm 20%	381(307)	0.50	0.35	0.60
CDRH3D23NP-470MC	M	47.0 \pm 20%	546(441)	0.35	0.25	0.55

※1. Inductance measuring condition: at 100kHz.

※2. Saturation current: The value of D.C. current when the inductance decreases to 65% of its nominal value.

※3. Temperature rise current: The value of D.C. current when the temperature rise is $\Delta t=40^{\circ}\text{C}$ ($T_a=20^{\circ}\text{C}$).

SMD Power Inductor CDRH3D23



Saturation Current & Temperature Rise Graph

— L (20°C) — L (100°C) — ΔT

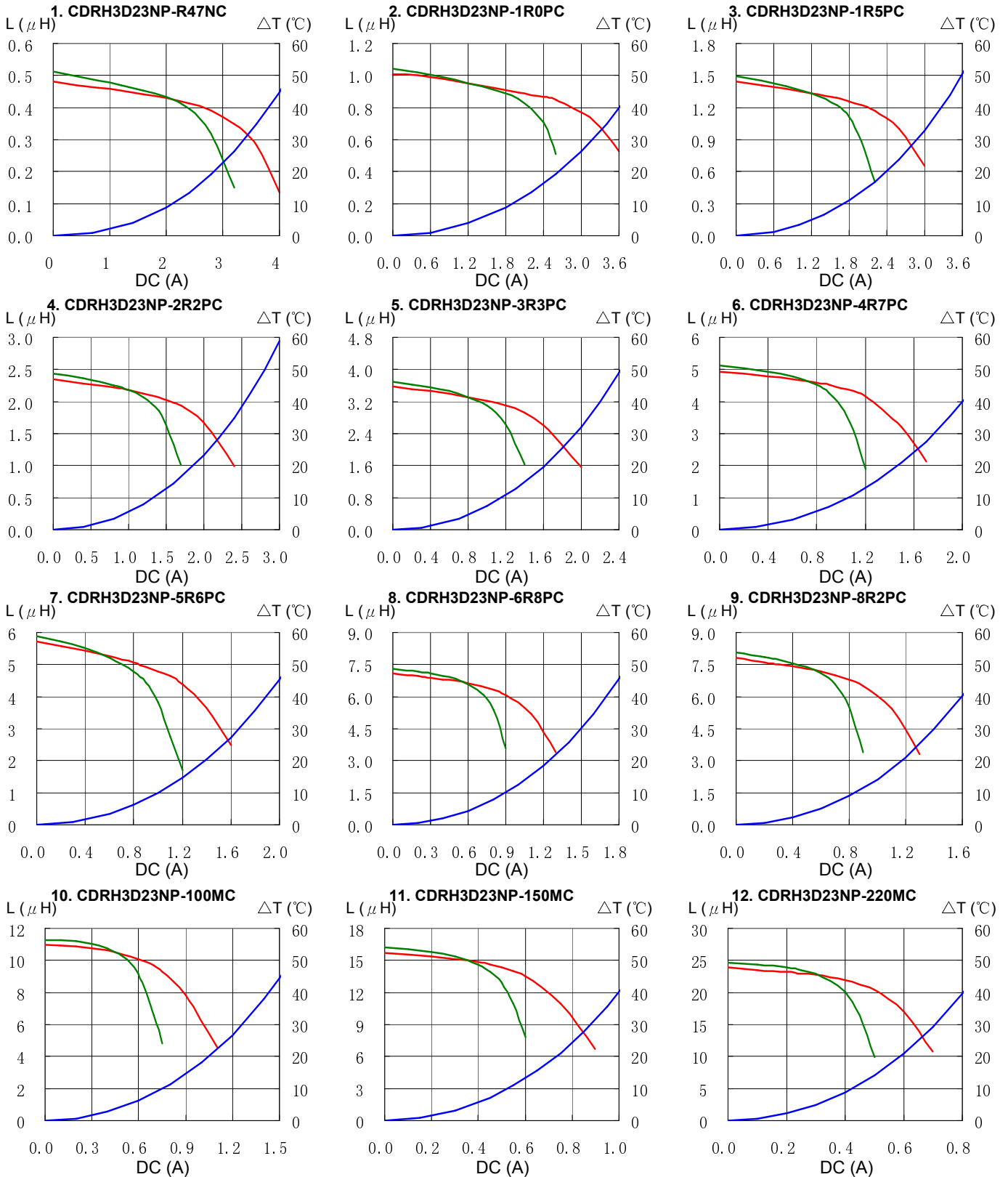

SMD Power Inductor CDRH3D23



Saturation Current & Temperature Rise Graph

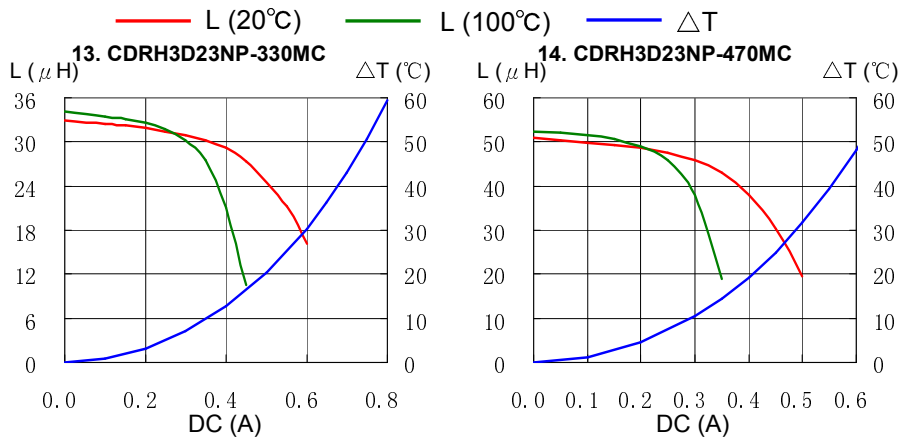

Solder Reflow Condition

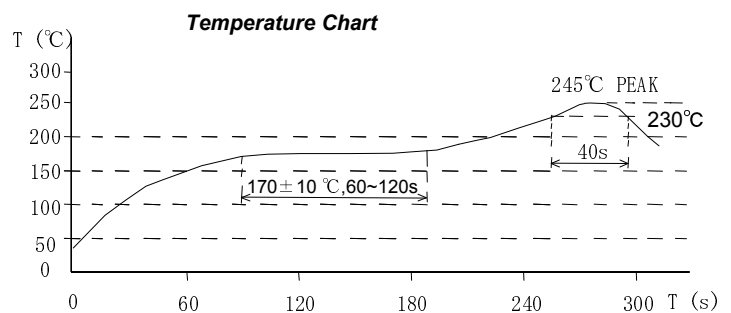
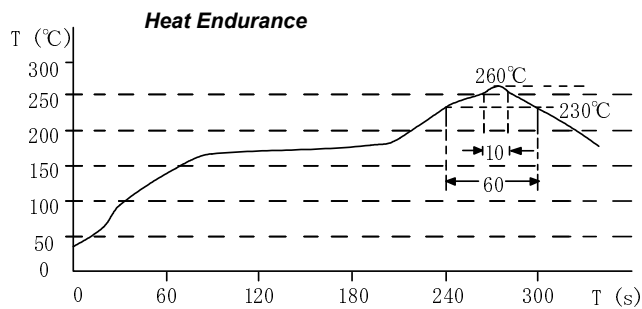

Please refer to the sales offices on our website - <http://www.sumida.com>

Hong Kong

Tel.+852-2880-6781
FAX.+852-2565-9600
sales@hk.sumida.com

Saitama(Japan)

Tel.+81-48-691-7300
FAX.+81-48-691-7340
sales@jp.sumida.com

Chicago

Tel.+1-847-545-6700
FAX. +1-847-545-6720
sales@us.sumida.com

Shanghai

Tel.+86-21-5836-3299
FAX.+86-21-5836-3266
shanghai.sales@cn.sumida.com

Seoul

Tel.+82-2-6237-0777
FAX.+82-2-6237-0778
sales@kr.sumida.com

Oberzell

Tel.+49-8591-937-0
FAX. +49-8591-937-103
contact@eu.sumida.com

Shenzhen

Tel.+86-755-8291-0228
FAX.+86-755-8291-0338
shenzhen.sales@cn.sumida.com

Singapore

Tel.+65-6296-3388
FAX.+65-6841-4426
sales@sg.sumida.com

Neumarkt

Tel.+49-9181-4509-110
FAX. +49-9181-4509-310
infocomp@eu.sumida.com

Taipei

Tel.+886-2-8751-2737
FAX.+886-2-8751-2738
sales@tw.sumida.com

San Jose

Tel.+1-408-321-9660
FAX.+1-408-321-9308
sales@us.sumida.com

Looking for pricing, stock, or lifecycle information?

Click below to explore more details on WIN SOURCE:

-  [View CDRH3D23NP-1R0PC on WIN SOURCE](#)
-  [Sumida America Components Inc. Information](#)

Optimize Your Supply Chain with WIN SOURCE Solutions

-  Global Sourcing Solution
-  Obsolete Management
-  Cost Control Management
-  Shortage Management
-  Alternative Solution
-  Excess Inventory Management