

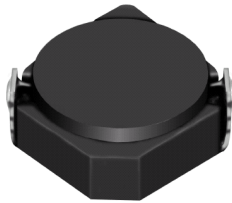

**THE DATASHEET OF
CDRH3D18NP-330NC**



SMD Power Inductor CDRH3D18



Description

- Ferrite drum core construction.
- Magnetically shielded.
- L × W × H: 4.0 × 4.0 × 2.0 mm Max.
- Product weight: 0.1g(Ref.)
- Moisture Sensitivity Level: 1
- RoHS compliance.

Environmental Data

- Operating temperature range: -40°C~+105°C (including coil's self temperature rise)
- Storage temperature range: -40°C~+105°C
- Solder reflow temperature: 260 °C peak.

Packaging

- Carrier tape and reel packaging
- 7.0" diameter reel
- 1000pcs per reel

Applications

- Ideally used in Mobilephone, PDA, MP3, DSC/DVC, etc as DC-DC converter inductors.

Dimension - [mm]

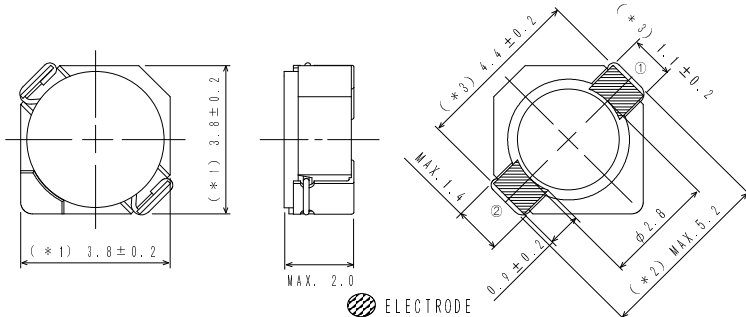

Land pattern and Schematics - [mm]

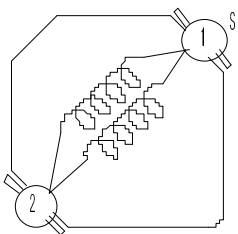
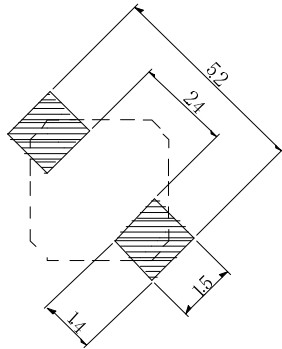

(1.0 μH ~ 6.8 μH)

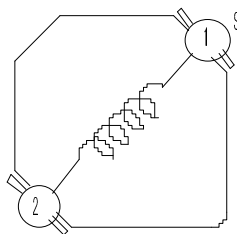

(10 μH ~ 47 μH)

SMD Power Inductor CDRH3D18



Electrical Characteristics

Part Name	Stamp	Inductance (μ H) [within] ※1	D.C.R. (m Ω) Max. (Typ.) (at 20°C)	Saturation Current (A) ※2		Temperature Rise Current (A) ※3
				at 20°C	at 100°C	
CDRH3D18NP-1R0NC	A	1.0 \pm 30%	50(40)	2.80	2.00	2.40
CDRH3D18NP-2R2NC	B	2.2 \pm 30%	63(50)	1.80	1.30	2.00
CDRH3D18NP-3R0NC	C	3.0 \pm 30%	69(55)	1.60	1.20	1.80
CDRH3D18NP-4R7NC	D	4.7 \pm 30%	107.5(86)	1.35	0.95	1.35
CDRH3D18NP-6R8NC	E	6.8 \pm 30%	150(120)	1.10	0.80	1.10
CDRH3D18NP-100NC	F	10.0 \pm 30%	205(164)	0.90	0.65	0.90
CDRH3D18NP-120NC	G	12.0 \pm 30%	275(220)	0.80	0.60	0.80
CDRH3D18NP-150NC	H	15.0 \pm 30%	302(241)	0.75	0.55	0.75
CDRH3D18NP-220NC	I	22.0 \pm 30%	424(339)	0.60	0.45	0.60
CDRH3D18NP-330NC	J	33.0 \pm 30%	640(512)	0.50	0.35	0.45
CDRH3D18NP-470NC	K	47.0 \pm 30%	964(771)	0.40	0.30	0.35

※1. Inductance measuring condition: at 100kHz.

※2. Saturation current: The value of D.C. current when the inductance decreases to 65% of it's nominal value.

※3. Temperature rise current: The value of D.C. current when the temperature rise is $\Delta t=40^{\circ}\text{C}$ ($T_a=20^{\circ}\text{C}$).

SMD Power Inductor CDRH3D18



Saturation Current & Temperature Rise Graph

— L (20°C) — L (100°C) — ΔT

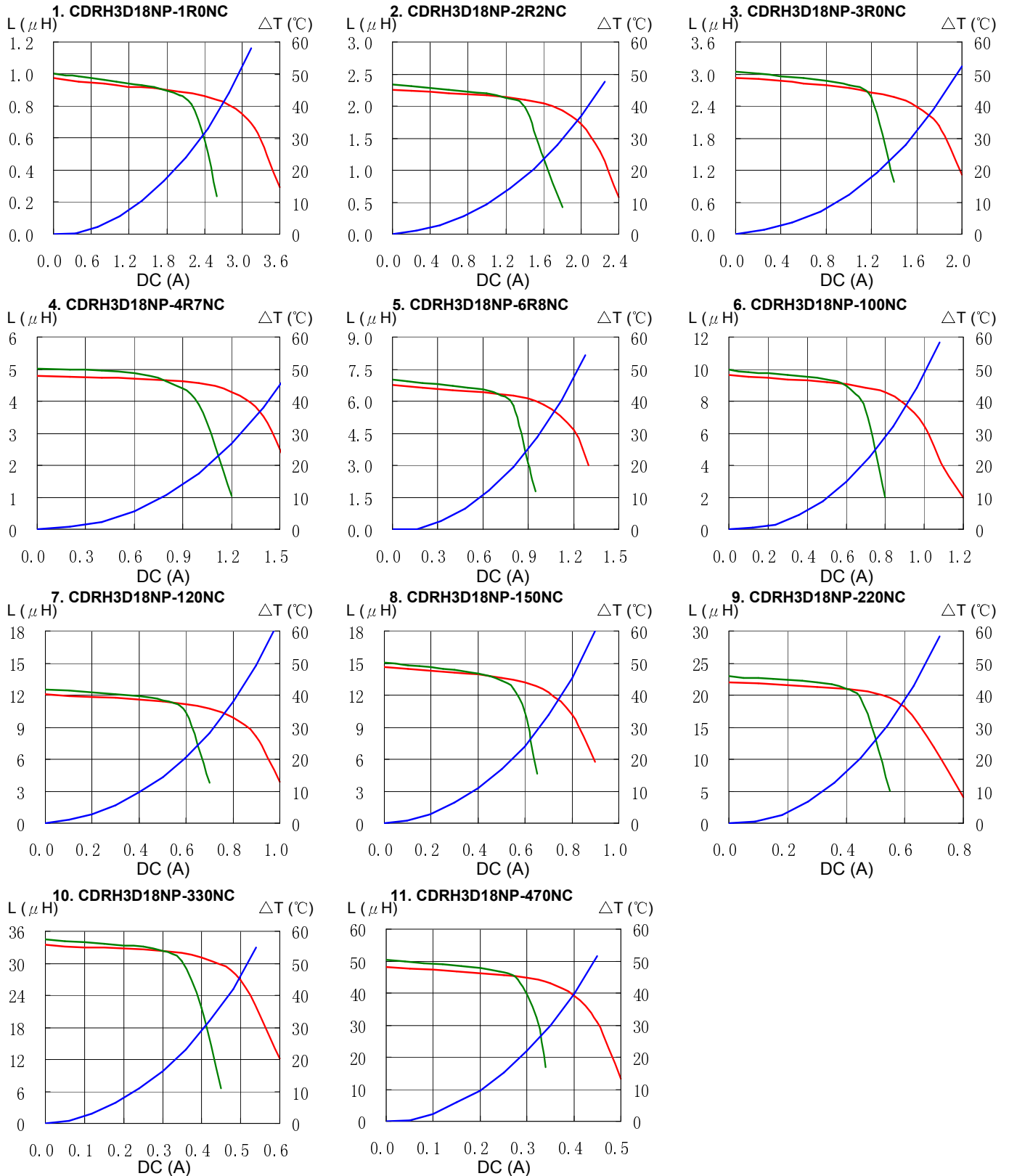

SMD Power Inductor CDRH3D18



Solder Reflow Condition

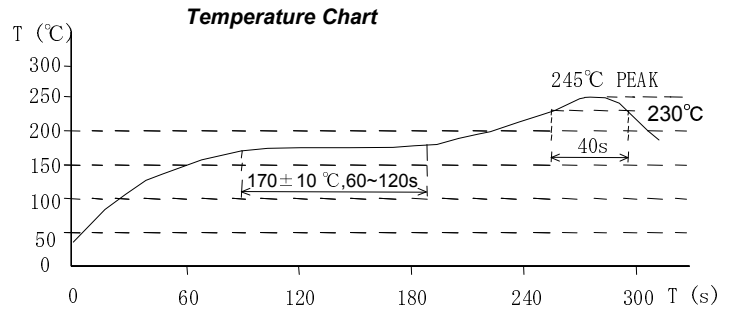
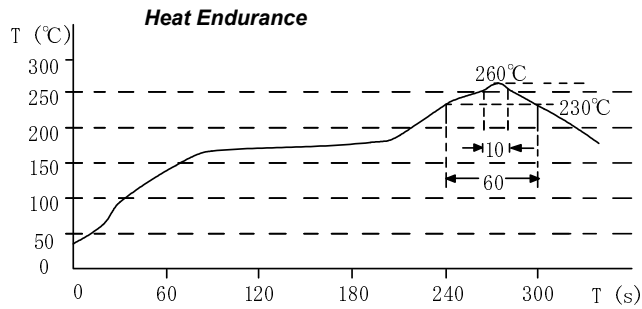

Please refer to the sales offices on our website - <http://www.sumida.com>

Hong Kong

Tel.+852-2880-6781
FAX.+852-2565-9600
sales@hk.sumida.com

Saitama(Japan)

Tel.+81-48-691-7300
FAX.+81-48-691-7340
sales@jp.sumida.com

Chicago

Tel.+1-847-545-6700
FAX. +1-847-545-6720
sales@us.sumida.com

Shanghai

Tel.+86-21-5836-3299
FAX.+86-21-5836-3266
shanghai.sales@cn.sumida.com

Seoul

Tel.+82-2-6237-0777
FAX.+82-2-6237-0778
sales@kr.sumida.com

Oberzell

Tel.+49-8591-937-0
FAX. +49-8591-937-103
contact@eu.sumida.com

Shenzhen

Tel.+86-755-8291-0228
FAX.+86-755-8291-0338
shenzhen.sales@cn.sumida.com

Singapore

Tel.+65-6296-3388
FAX.+65-6841-4426
sales@sg.sumida.com

Neumarkt

Tel.+49-9181-4509-110
FAX. +49-9181-4509-310
infocomp@eu.sumida.com

Taipei

Tel.+886-2-8751-2737
FAX.+886-2-8751-2738
sales@tw.sumida.com

San Jose

Tel.+1-408-321-9660
FAX.+1-408-321-9308
sales@us.sumida.com

Looking for pricing, stock, or lifecycle information?

Click below to explore more details on WIN SOURCE:

- ⊖ [View CDRH3D18NP-330NC on WIN SOURCE](#)
- ⊖ [Sumida America Components Inc. Information](#)

Optimize Your Supply Chain with WIN SOURCE Solutions

- ✓ Global Sourcing Solution
- ✓ Obsolete Management
- ✓ Cost Control Management
- ✓ Shortage Management
- ✓ Alternative Solution
- ✓ Excess Inventory Management