

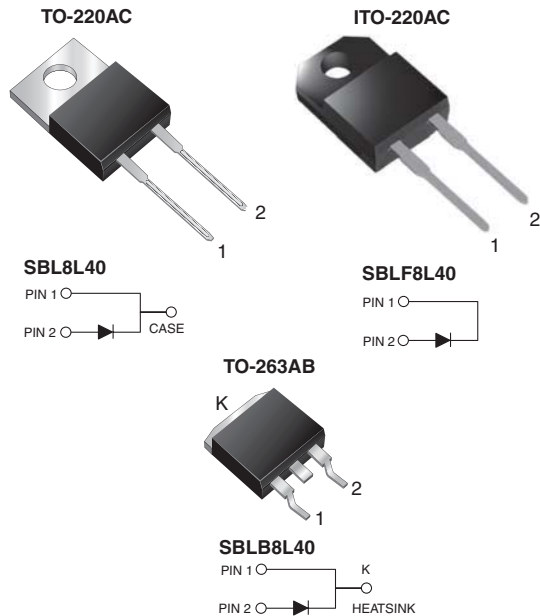

**THE DATASHEET OF  
SBLB8L40HE3/45**



## Schottky Barrier Rectifier



### FEATURES

- Power pack
- Guardring for overvoltage protection
- Lower power losses, high efficiency
- Low forward voltage drop
- High forward surge capability
- High frequency operation
- Meets MSL level 1, per J-STD-020C, LF maximum peak of 245 °C (for TO-263AB package)
- Solder bath temperature 275 °C maximum, 10 s, per JESD 22-B106 (for TO-220AC and ITO-220AC package)
- AEC-Q101 qualified
- Material categorization: For definitions of compliance please see [www.vishay.com/doc?99912](http://www.vishay.com/doc?99912)



RoHS  
COMPLIANT

### TYPICAL APPLICATIONS

For use in low voltage, high frequency rectifier of switching mode power supplies, freewheeling diodes, DC/DC converters, and polarity protection application.

### MECHANICAL DATA

**Case:** TO-220AC, ITO-220AC, TO-263AB

Molding compound meets UL 94 V-0 flammability rating  
Base P/N-E3 - RoHS-compliant, commercial grade  
Base P/NHE3 - RoHS-compliant, AEC-Q101 qualified

**Terminals:** Matte tin plated leads, solderable per J-STD-002 and JESD 22-B102

E3 suffix meets JESD 201 class 1A whisker test, HE3 suffix meets JESD 201 class 2 whisker test

**Polarity:** As marked

**Mounting Torque:** 10 in-lbs maximum

PRIMARY CHARACTERISTICS	
$I_{F(AV)}$	8 A
$V_{RRM}$	40 V
$I_{FSM}$	250 A
$V_F$	0.41 V
$T_J \text{ max.}$	125 °C
Package	TO-220AC, ITO-220AC, TO-263AB
Diode variations	Single

MAXIMUM RATINGS ( $T_C = 25 \text{ °C}$ unless otherwise noted)					
PARAMETER	SYMBOL	SBL8L40	SBLF8L40	SBLB8L40	UNIT
Maximum repetitive peak reverse voltage	$V_{RRM}$	40			V
Working peak reverse voltage	$V_{RWM}$	28			
Maximum DC blocking voltage	$V_{DC}$	40			
Maximum average forward rectified current at (fig. 1)	$I_{F(AV)}$	8			A
Peak forward surge current 8.3 ms single half sine-wave superimposed on rated load per leg	$I_{FSM}$	250			
Peak repetitive reverse current at $t_p = 2 \text{ ms}$ , 1 kHz	$I_{RRM}$	1.0			
Voltage rate of change (rated $V_R$ )	$dV/dt$	10 000			
Operating junction and storage temperature range	$T_J, T_{STG}$	- 65 to + 125			°C
Isolation voltage (ITO-220AC only) from terminal to heatsink $t = 1 \text{ min}$	$V_{AC}$	1500			V



<b>ELECTRICAL CHARACTERISTICS</b> ( $T_C = 25\text{ }^\circ\text{C}$ unless otherwise noted)					
PARAMETER	SYMBOL	TEST CONDITIONS		VALUE	UNIT
Maximum instantaneous forward voltage	$V_F$ (1)	$I_F = 4\text{ A}$	$T_J = 25\text{ }^\circ\text{C}$	0.44	V
		$I_F = 4\text{ A}$	$T_J = 125\text{ }^\circ\text{C}$	0.35	
		$I_F = 8\text{ A}$	$T_J = 25\text{ }^\circ\text{C}$	0.50	
		$I_F = 8\text{ A}$	$T_J = 125\text{ }^\circ\text{C}$	0.41	
Maximum instantaneous reverse current at DC blocking voltage	$I_R$ (2)	Rated $V_R$	$T_J = 25\text{ }^\circ\text{C}$	1.0	mA
			$T_J = 100\text{ }^\circ\text{C}$	75	

**Notes**(1) Pulse test: 300  $\mu\text{s}$  pulse width, 1 % duty cycle(2) Pulse test: Pulse width  $\leq 40\text{ ms}$ 

<b>THERMAL CHARACTERISTICS</b> ( $T_C = 25\text{ }^\circ\text{C}$ unless otherwise noted)					
PARAMETER	SYMBOL	SBL	SBLF	SBLB	UNIT
Typical thermal resistance from junction to case per leg	$R_{\theta JC}$	3.2	4.0	3.2	$^\circ\text{C/W}$

<b>ORDERING INFORMATION</b> (Example)					
PACKAGE	PREFERRED P/N	UNIT WEIGHT (g)	PACKAGE CODE	BASE QUANTITY	DELIVERY MODE
TO-220AC	SBL8L40-E3/45	1.80	45	50/tube	Tube
ITO-220AC	SBLF8L40-E3/45	1.94	45	50/tube	Tube
TO-263AB	SBLB8L40-E3/45	1.33	45	50/tube	Tube
TO-263AB	SBLB8L40-E3/81	1.33	81	800/reel	Tape and reel
TO-220AC	SBL8L40HE3/45 (1)	1.80	45	50/tube	Tube
ITO-220AC	SBLF8L40HE3/45 (1)	1.94	45	50/tube	Tube
TO-263AB	SBLB8L40HE3/45 (1)	1.33	45	50/tube	Tube
TO-263AB	SBLB8L40HE3/81 (1)	1.33	81	800/reel	Tape and reel

**Note**

(1) AEC-Q101 qualified



## RATINGS AND CHARACTERISTICS CURVES

( $T_A = 25\text{ }^\circ\text{C}$  unless otherwise noted)

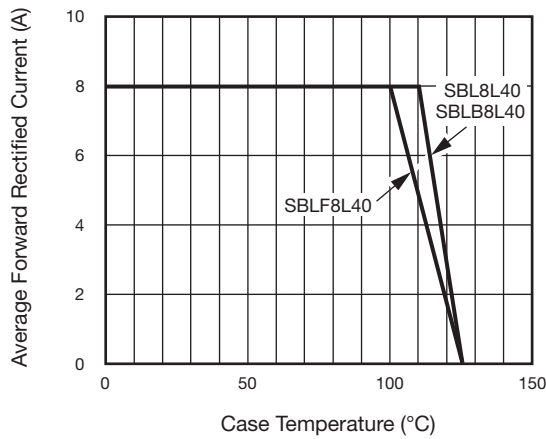

Fig. 1 - Maximum Forward Current Derating Curve

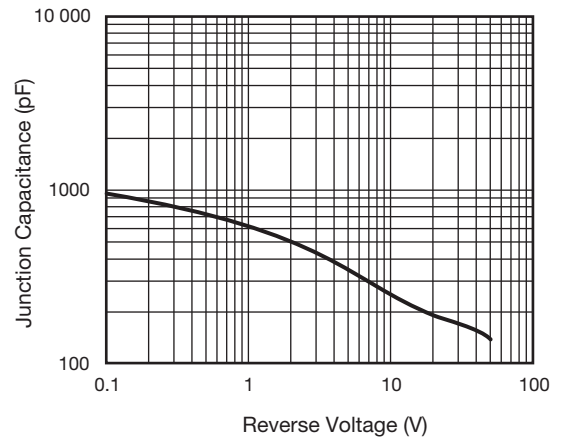

Fig. 4 - Typical Junction Capacitance

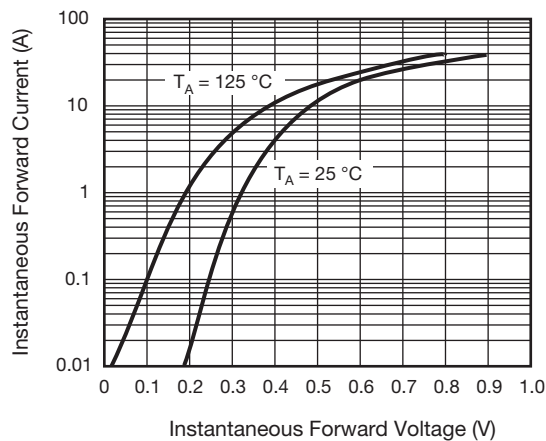

Fig. 2 - Typical Instantaneous Forward Characteristics

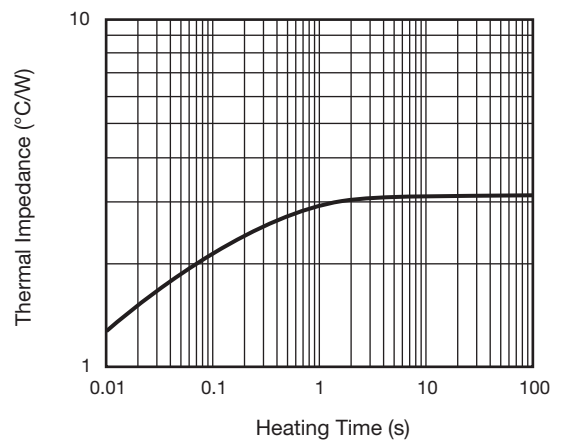

Fig. 5 - Transient Thermal Impedance

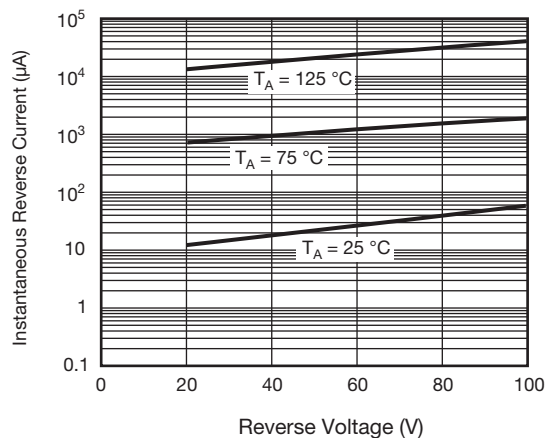
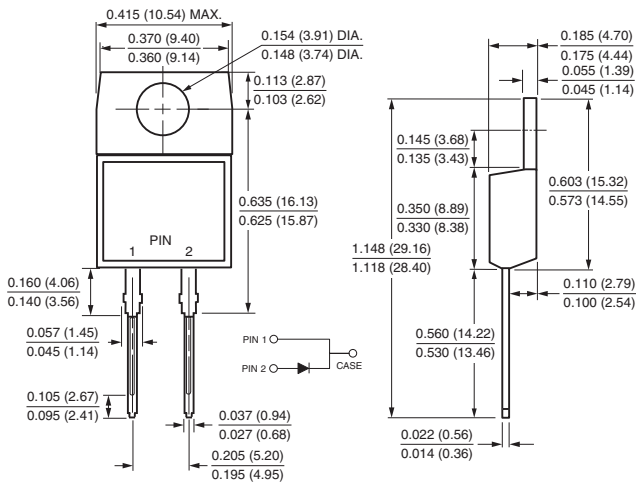

Fig. 3 - Typical Reverse Characteristics



### PACKAGE OUTLINE DIMENSIONS in inches (millimeters)

#### TO-220AC



#### ITO-220AC

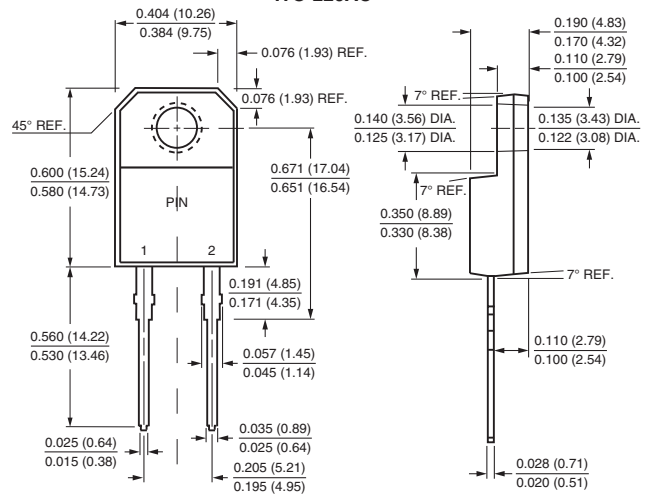

#### TO-263AB

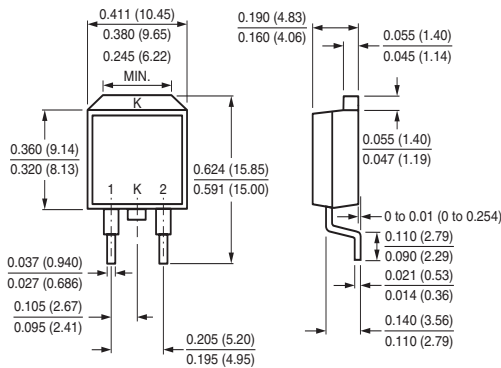

#### Mounting Pad Layout

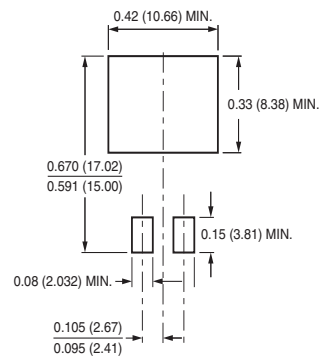



## **Disclaimer**

ALL PRODUCT, PRODUCT SPECIFICATIONS AND DATA ARE SUBJECT TO CHANGE WITHOUT NOTICE TO IMPROVE RELIABILITY, FUNCTION OR DESIGN OR OTHERWISE.

Vishay Intertechnology, Inc., its affiliates, agents, and employees, and all persons acting on its or their behalf (collectively, "Vishay"), disclaim any and all liability for any errors, inaccuracies or incompleteness contained in any datasheet or in any other disclosure relating to any product.

Vishay makes no warranty, representation or guarantee regarding the suitability of the products for any particular purpose or the continuing production of any product. To the maximum extent permitted by applicable law, Vishay disclaims (i) any and all liability arising out of the application or use of any product, (ii) any and all liability, including without limitation special, consequential or incidental damages, and (iii) any and all implied warranties, including warranties of fitness for particular purpose, non-infringement and merchantability.

Statements regarding the suitability of products for certain types of applications are based on Vishay's knowledge of typical requirements that are often placed on Vishay products in generic applications. Such statements are not binding statements about the suitability of products for a particular application. It is the customer's responsibility to validate that a particular product with the properties described in the product specification is suitable for use in a particular application. Parameters provided in datasheets and / or specifications may vary in different applications and performance may vary over time. All operating parameters, including typical parameters, must be validated for each customer application by the customer's technical experts. Product specifications do not expand or otherwise modify Vishay's terms and conditions of purchase, including but not limited to the warranty expressed therein.

Except as expressly indicated in writing, Vishay products are not designed for use in medical, life-saving, or life-sustaining applications or for any other application in which the failure of the Vishay product could result in personal injury or death. Customers using or selling Vishay products not expressly indicated for use in such applications do so at their own risk. Please contact authorized Vishay personnel to obtain written terms and conditions regarding products designed for such applications.

No license, express or implied, by estoppel or otherwise, to any intellectual property rights is granted by this document or by any conduct of Vishay. Product names and markings noted herein may be trademarks of their respective owners.

## Looking for pricing, stock, or lifecycle information?

Click below to explore more details on WIN SOURCE:

 [View SBLB8L40HE3/45 on WIN SOURCE](#)

 [Vishay Information](#)

## Optimize Your Supply Chain with WIN SOURCE Solutions

-  Global Sourcing Solution
-  Obsolete Management
-  Cost Control Management
-  Shortage Management
-  Alternative Solution
-  Excess Inventory Management