



**THE DATASHEET OF  
TC234LX32F200FABKXUMA1**





Highly integrated and performance optimized  
32-bit microcontrollers for automotive and industrial applications

# Contents

TriCore™ family concept	3
Evolution of TriCore™ generations	4
TriCore™ based product roadmap	5
PRO-SIL™ safety concept	6
AURIX™ family system architecture	7
Embedded software (AUTOSAR etc.)	15
Development support	17
AURIX™ for powertrain applications	20
AURIX™ for safety applications	30
AURIX™ for connectivity applications	40
AURIX™ for transportation applications	44
AURIX™ for industrial applications	46
Tool partners	51



### Family highlights

- > Compatibility and scalability
- > Lowest system cost
- > Industry benchmark system performance
- > Easy to use
- > Broad portfolio
- > Certified to automotive standards

### Powertrain



### Applications

- > Gasoline direct injection
- > Gasoline multi-port Injection
- > Diesel direct injection
- > Automatic transmission – hydraulic control
- > Dry double clutch transmission – hydraulic control
- > Dry double clutch transmission – electrical control
- > Integrated (H)EV control
- > (H)EV battery management system

### Safety



### Applications

- > Chassis domain control
- > Electric Power Steering (EPS)
- > Active suspension control system
- > Advanced airbag system
- > Braking ECU
- > Multi-purpose camera configuration
- > Short-range radar (24 GHz) system
- > Long-range radar (76/77 GHz) system

### Connectivity



### Applications

- > Body domain controller
- > Connected gateway
- > Advanced body applications
- > Telematics including software update over the air
- > V2x communication
- > eHorizon

### Transportation



### Applications

- > Commercial and Agricultural Vehicle (CAV)
- > Fun vehicle
- > Transportation
- > Trucks

### Industrial & Multimarket



### Applications

- > Mobile controller
- > Inverter
- > Wind turbine inverter
- > Solar panel



## Evolution of TriCore™ generations

In 1999, Infineon launched the first generation of the AUDO (AUtomotive unifiedD processOr) family. Based on a unified RISC/MCU/DSP processor core, this 32-bit TriCore™ microcontroller was a computational power horse. And the company has evolved and optimized the concept ever since – culminating in what is now the fifth TriCore™ generation.

The TriCore™ success story continues with the introduction of the AURIX™ multicore family. AURIX™ combines easy-to-use functional safety support, a strong increase in performance and a future-proven security solution in a highly scalable product family.



With its high real-time performance, embedded safety and security features, the TriCore™ family is the ideal platform for a wide range of automotive applications such as the control of combustion engines, electrical and hybrid vehicles, transmission control units, chassis domains, braking systems, electric power steering systems, airbags and advanced driver assistance systems. TriCore™-based products also deliver the versatility required for the industrial sector, excelling in optimized motor control applications and signal processing. Infineon's broad product portfolio allows engineers to choose from a wide range of memories, peripheral sets, frequencies, temperatures and packaging options. And all this with a high degree of compatibility across generations.

The new AURIX™ family members are manufactured in a 65nm embedded Flash technology designed for ultimate reliability in harsh automotive environments. Furthermore, the dual frontend concept ensures continuous supply.

As was the case with previous generations, safety software is also available to help manufacturers meet SIL/ ASIL safety standards, as well as AUTOSAR libraries which Infineon has been developing since 2005.

# TriCore™ based product roadmap

Segment	Production			Development	
	AUDO family		AURIX™ family	AURIX™ family	
	130 nm	90 nm	65 nm	65 nm	
High end	TC1797 180 MHz, 4 MB	TC1798 300 MHz, 4 MB	TC29x 300 MHz, 8 M		TC290 Bare die
		TC1793 270 MHz, 4 MB	TC27x 200 MHz, 4 M		
		TC1791 240 MHz, 4 MB			TC270 200 MHz, 4 M Bare die
Mid range	TC1768 133 MHz, 3 M Bare die	TC1746 180 MHz, 2.5 M Bare die			
		TC1784 180 MHz, 2.5 MB	TC26x 200 MHz, 2.5 M		
		TC1782 180 MHz, 2.5 MB			TC260 200 MHz, 2.5 M Bare die
	TC1767 80/133 MHz, 2 MB		TC23x 200 MHz, 2 M		
Low end		TC1728 133 MHz, 1.5 MB			
		TC1724 80 MHz, 1.5 MB			
			TC22x 133 MHz, 1 M		
	TC1736 80 MHz, 1 MB		TC21x 100 MHz, 0.5 M		
Companion ICs	CIC61508 Safety IC				

Production
  Development
  Concept / on request



Infineon's PRO-SIL™ program, designed to protect

The functional complexity and levels of integration of real-time safety-critical applications continue to increase exponentially. In addition, the product life cycle of these applications has to meet stringent safety standards. Norms such as IEC 61508 and ISO 26262 mandate more robust and comprehensive product development processes and functional safety concepts in automotive and industrial applications.

Infineon's PRO-SIL™ safety program is designed to ease and speed up your automotive and industrial design to comply with such standards. Across the full certification spectrum from Safety Integrity Levels (SIL) 1 to 4 and Automotive Safety Integrity Levels (ASIL) A to D, our end-to-end PRO-SIL™ approach will help you select the right hardware, software and functional safety concepts to meet your design and compliance needs.

### PRO-SIL™ highlights

- › Broad hardware portfolio from sensors to microcontrollers, along with analog and power management ICs providing SIL-supporting features.
- › For ISO 26262 PRO-SIL™ products, safety concepts are in place to enable the required safety measures, testing, monitoring and diagnostics capabilities for your safety architecture.
- › Comprehensive safety software packages for seamless integration are in place, such as the SafeTlib software for Infineon's AURIX™ microcontroller family
- › Full range of support services – from consulting and design advice, including training, documentation and technical support – can be provided.
- › Safety-focused organization and project management based on Infineon's zero defect program, safety culture and quality management system are in place.

Infineon's PRO-SIL™ logo guides you to our products (HW, SW, safety documentation) with SIL-supporting features. These products will simplify the implementation of customers' system design and improve time-to-market in achieving the desired functional safety level compliance.

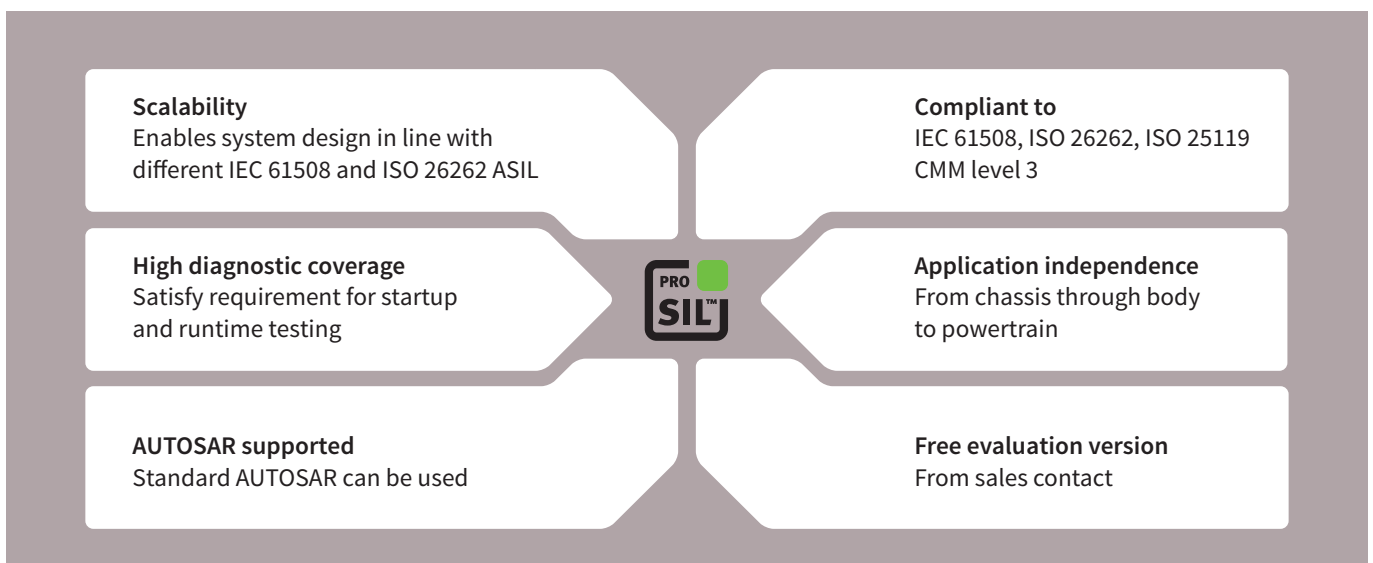

# AURIX™ family system architecture

AURIX™ is Infineon's brand new family of microcontrollers serving exactly the needs of the automotive industry in terms of performance and safety. Its innovative multicore architecture, based on up to three independent 32-bit TriCore™ CPUs, has been designed to meet the highest safety standards while significantly increasing performance at the same time.

Using the AURIX™ platform, automotive developers will be able to control powertrain and safety applications with one single MCU platform. Developments using AURIX™ will require less effort to achieve the ASIL-D standard than with a classical lockstep architecture.

Customers wanting to reduce their time-to-market can now cut down their MCU safety development by 30%. By the same token, a performance surplus of 50% up to 100% allows for more functionality and offers a sufficient resource buffer for future requirements, keeping the power consumption on the single-core microcontroller level. While protecting IP, and preventing theft and fraud, AURIX™ provides an already built-in hardware security module.

With its special feature set, AURIX™ is the perfect match for powertrain applications (including hybrid and electrical vehicles) as well as safety applications (such as steering, braking, airbag and advanced driver assistance systems).

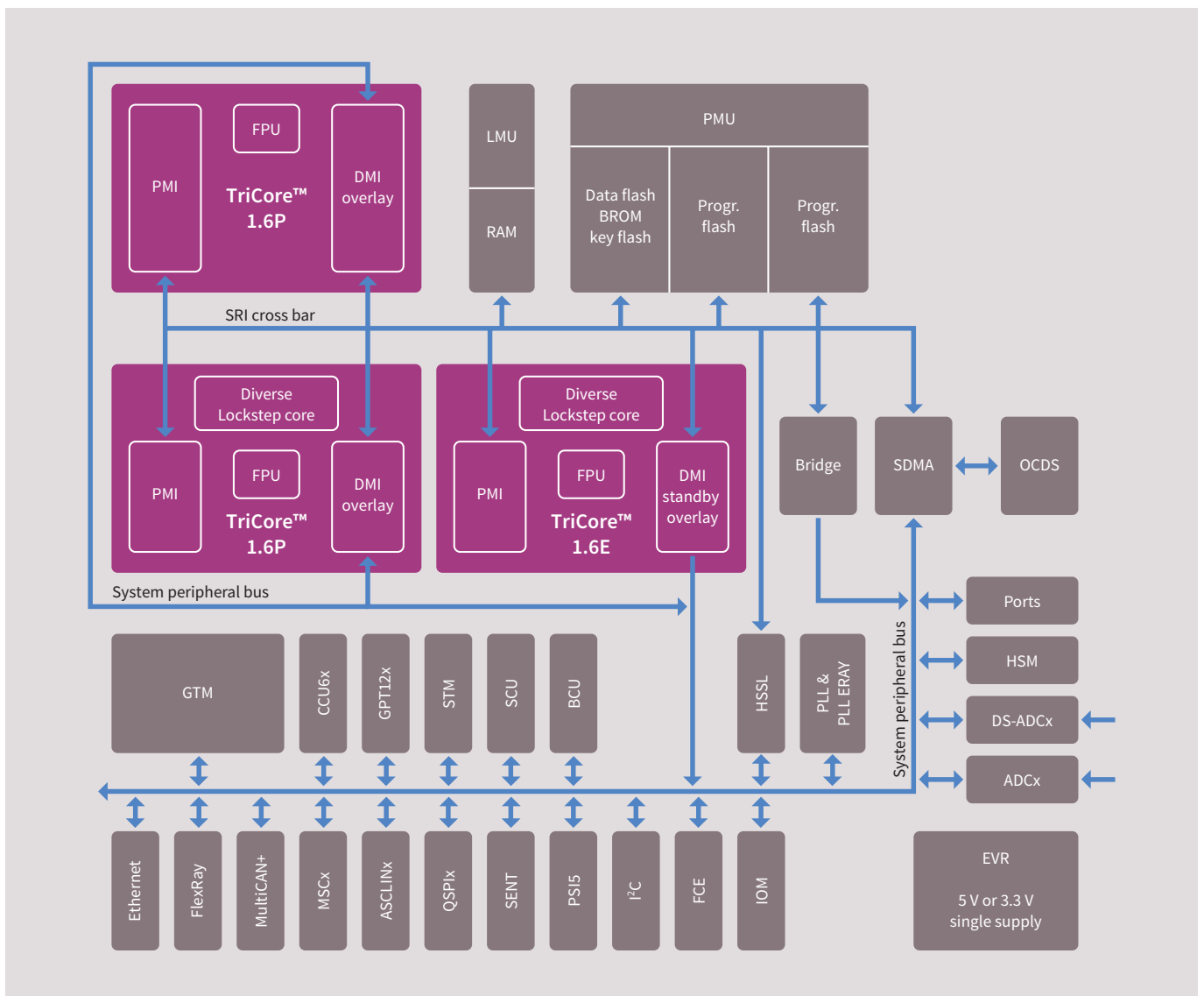

## AURIX™ family package scalability

	TQFP-80	TQFP-100	LQFP-144 TQFP-144	LQFP-176	LFBGA-292	BGA-416	LFBGA-516
<b>9x series</b> up to 8 MB max. SRAM 2.75 MB triple-core					TC297	TC298	TC299
<b>7x series</b> up to 4 MB max. SRAM 472 KB triple-core				TC275	TC277		
<b>6x series</b> up to 2.5 MB max. SRAM 752 KB dual-core			TC264	TC265	TC267		
<b>3x series</b> up to 2 MB max. SRAM 708 KB Lockstep-core		TC233	TC234		TC237		
<b>2x series</b> up to 1 MB max. SRAM 96 KB Lockstep-core	TC222	TC223	TC224				
<b>1x series</b> up to 512 KB max. SRAM 56 KB Lockstep-core	TC212	TC213	TC214				

↕ Upgrade/downgrade with pin-compatible packages

- › Advanced package technologies deliver the best price/performance ratio
- › Customers can choose between different devices in the same pin-compatible package

## TriCore™ upgrade paths

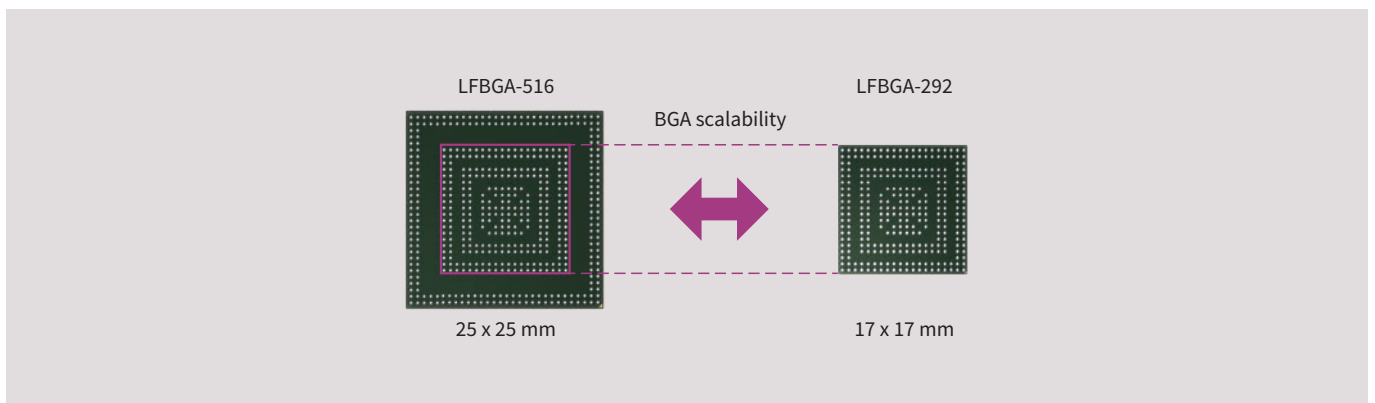

- › LFBGA-292 and LFBGA-516 are ball compatible so that customers can build one PCB for both packages

# Package information<sup>1)</sup>

**LFBGA-516**

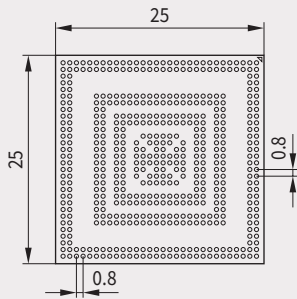

**BGA-416**

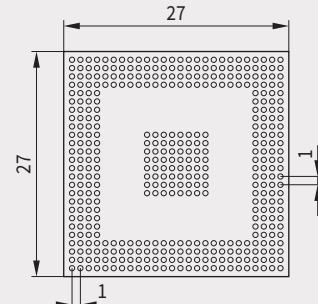

**LFBGA-292**

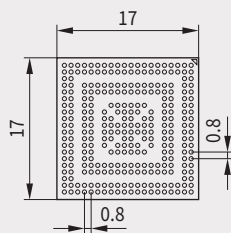

**LQFP-176**

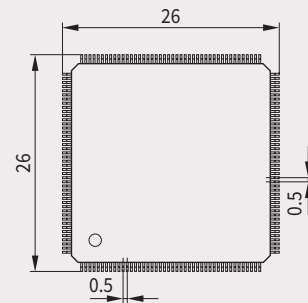

**LQFP-144**

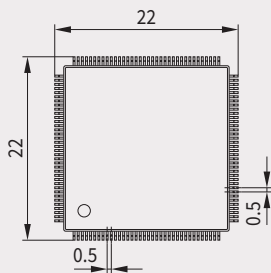

**TQFP-144**

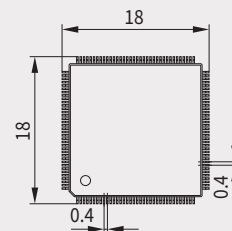

**TQFP-100**

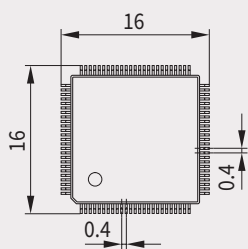

**TQFP-80**

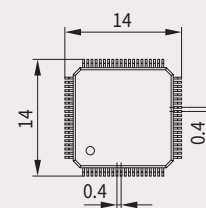

1) For further information on Infineon packages, please visit our internet site at [www.infineon.com/packages](http://www.infineon.com/packages)

## Infineon® diverse lockstep concept

- › Lockstep architecture designed to control and mitigate common cause factors
  - Physical isolation
  - Instruction-level execution diversity: 2-cycle delay
  - Circuit-level design & timing diversity
- › Layout-level diversity
- › Diversity controlled and verified by state-of-the-art design methods
- › Special design of clock & reset networks
- › Careful design of lockstep comparator
- › Main core and diverse lockstep core run the same software in parallel to detect computational errors
- › Like normal locksteps, both cores are physically separated and have a time delay between their execution
- › Diverse lockstep core has been additionally transformed to provide architectural hardware diversity and further reduce common cause failures

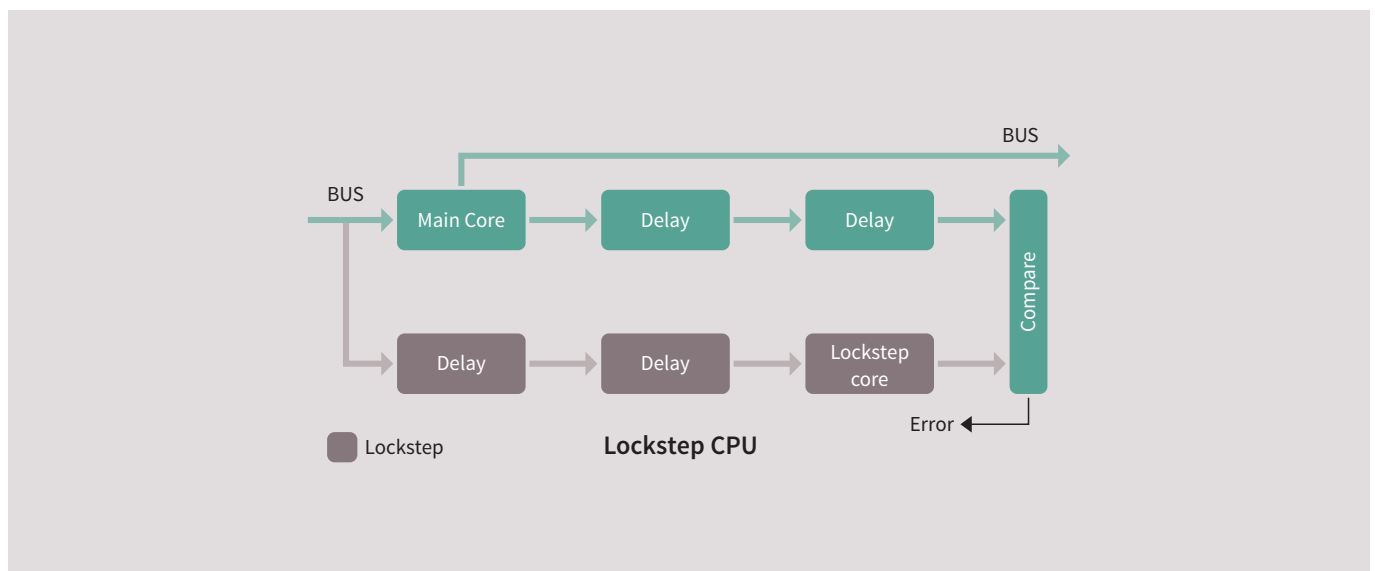

## Multi-AUTOSAR OS support on one microcontroller

- > AURIX™ provides a memory protection system for each core plus an additional distributed hardware-based resource management system
- > Each peripheral and shared SRAM has a resource management unit that works as a local access protection mechanism to allow or deny access
- > When combined with the memory protection system, this hardware can be used to prevent selected direct access from certain tasks or cores to peripherals or regions of SRAMs and instead redirect the attempted access to a hypervisor function
- > The hypervisor can arbitrate/grant/deny access and therefore provide paravirtualization of mixed-criticality tasks in a unified sub-system architecture with a minimal CPU overhead
- > AURIX™ therefore provides the ability to run mixed-criticality software requiring real-time access while still enforcing encapsulation and freedom of interference between cores, even when the cores are not running time and memory-protected operating systems

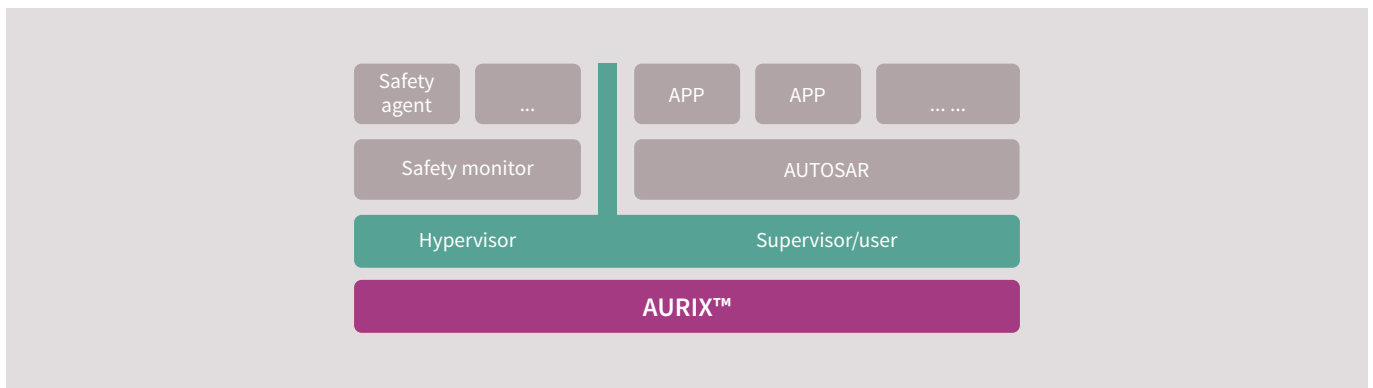

## AURIX™ protection system overview

- > Hardware support for freedom of interference
  - Between SW components
  - Between HW parts
  - Between HW parts & SW components
- > Timing protection

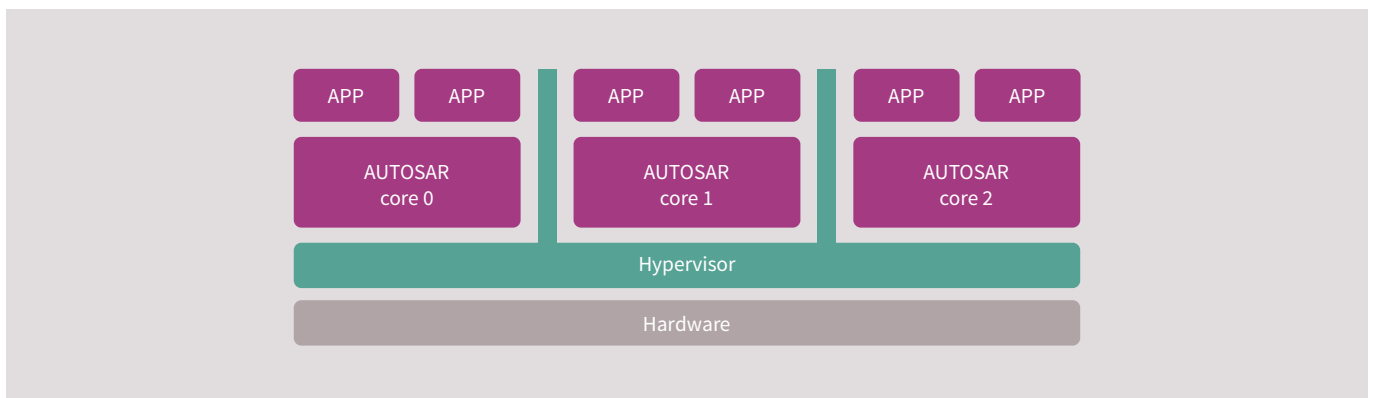

## AURIX™ family communication innovation

### AURIX™ MultiCAN

- › Up to 6 CAN nodes with FD support available
- › CAN standard V2.0 B active
- › ISO11898-1 FDIS 2014 CAN-FD
- › Specific AURIX™ variants support ISO11898-1 DIS 2015
- › Resonator ready with asynchronous operation and choice of clock source
- › Frequency scaling without baud rate change
- › Energy saving: pretended networking and partial networking (ISO11898-6 transceiver support) support (also in CAN FD mode)
- › Safety support: total amount of bus errors countable
- › Message objects can be freely assigned among the nodes
- › Configurable FIFO length, automatic gateway mode support
- › Acceptance mask filtering for each message object



## Ethernet

### Highlights

- › MAC integrated in  $\mu$ C
- › IEEE 802.3-2002 for Ethernet with support of IP, TCP/IP, UDP ...
- › Real-time stamping support (IEEE 1588-2008) for clock synchronization
- › Standard MII and RMI interfaces to PHY
- › Fast Ethernet w/ 100 Mbit
- › AUTOSAR V4 features supported
- › Automatic CRC checksum and padding support
- › AVB support

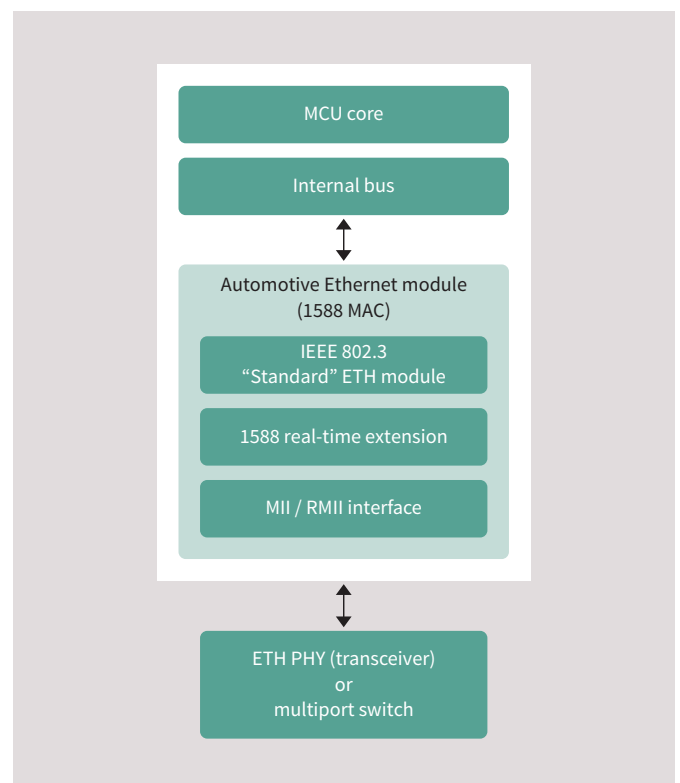

## AURIX™ family offers a complete roadmap for automotive security

	TQFP-100	TQFP-144	LQFP-176	LFBGA-292	LFBGA-516	Bare Die
<b>9x series</b> up to 8 MB				TC297T 270 MHz HSM	TC299T 270 MHz HSM	TC290T 270 MHz HSM
<b>7x series</b> up to 4 MB			TC275T 200 MHz HSM	TC277T 200 MHz HSM		TC270T 200 MHz HSM
<b>3x series</b> up to 2 MB	TC233L 200 MHz HSM	TC234L 200 MHz HSM		TC237L 200 MHz HSM		

High-end engine & transmission management  
 ADAS & sensor fusion domain control (H)EV System

Mid-range engine & transmission management  
 High-end brake and EPS domain control (H)EV system

EPS airbag brake systems ADAS

### Typical use cases

- > Secure on-board communication
- > Tuning protection
- > Immobilizer
- > Secure SW update

## AURIX™ hardware security module – anchor of trust thanks to separated logical protection domain

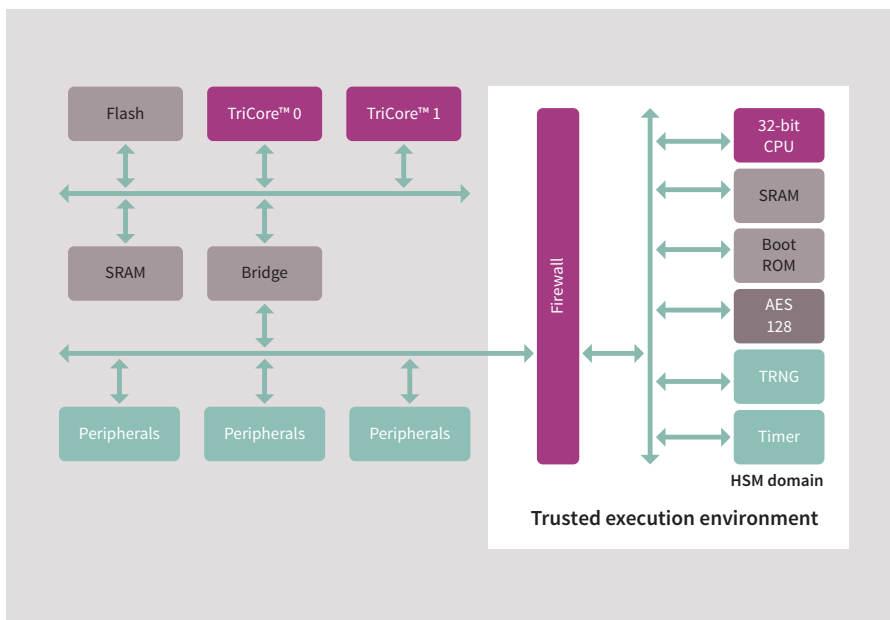

### AURIX™ Hardware Security Module (HSM)

- > A highly flexible and programmable solution
  - AES128 and TRNG implemented in HW
  - Customer-specific requirements, such as HASH or asymmetric encryption, can be implemented in software
- > Offers the performance required to encrypt/decrypt e.g. Ethernet traffic
- > Secure key storage provided by separated HSM-DFLASH portion
  - Alternative secure key storage feasible in dedicated HSM-PFLASH sections
- > SHE+ software



The SHE+ driver controls the hardware security peripheral in the HSM domain and interacts with the TriCore™ host core. SHE+ offers the AUTOSAR CRY interface for integrating the HSM security features into an automotive application, including interface to AUTOSAR, communication from TriCore™ to HSM and vice versa, key storage functionality and security peripheral drivers.

## AURIX™ security software

Infineon's AURIX™ 32-bit microcontroller family offers a wide portfolio of compatible devices with embedded Hardware Security Module (HSM), which offers cost-efficient solutions for all typical automotive security applications. The SHE+ driver controls the hardware security peripheral in the HSM domain and interacts with the TriCore™ host

core. SHE+ comes with the AUTOSAR CRY interface for integrating the HSM security features into an automotive application, including interface to AUTOSAR, communication from TriCore™ to HSM and vice versa, key storage functionality and security peripheral drivers.

	HIS SHE	HSM SHE+ V1	HSM SHE+ envisioned
Key management	10 keys	20 keys	Configurable
Symmetric data encryption / decryption	HW-based AES-128-bit (ECB, CBC)	HW-based AES-128-bit (ECB, CBC, OFB, CFB, CTR, XTC, GCM)	●
MAC generation / verification	●	●	●
Safe MAC verification	-	●	●
Random number management	SHE PRNG	SHE PRNG TRNG	●
Secure boot	●	-	●
Debug access	-	-	Enhanced by HSM debug options
Other SHE services	●	●	●
Asymmetric encryption / decryption	-	-	SW-based RSA1024 SW-based ECC256

Typical applications	Tuning protection 	Immobilizer  Secure-on-board communication 	Possible extensions, depending on specific tier1 / OEM use case
Key management	●	●	●
Symmetric data encryption / decryption	●	●	●
MAC generation / verification	●	●	●
Safe MAC verification		(optional)	(optional)
Random number management	●	●	●
Secure boot	(optional)	(optional)	(optional)
Debug access	(for development)	(for development)	(for development)
Other SHE services	●	●	●
Asymmetric encryption / decryption	(optional in future)	(optional in future)	(optional in future)

# Embedded software

## TriCore™ performance

Real-life application benchmark (software controlling a four-cylinder diesel engine)

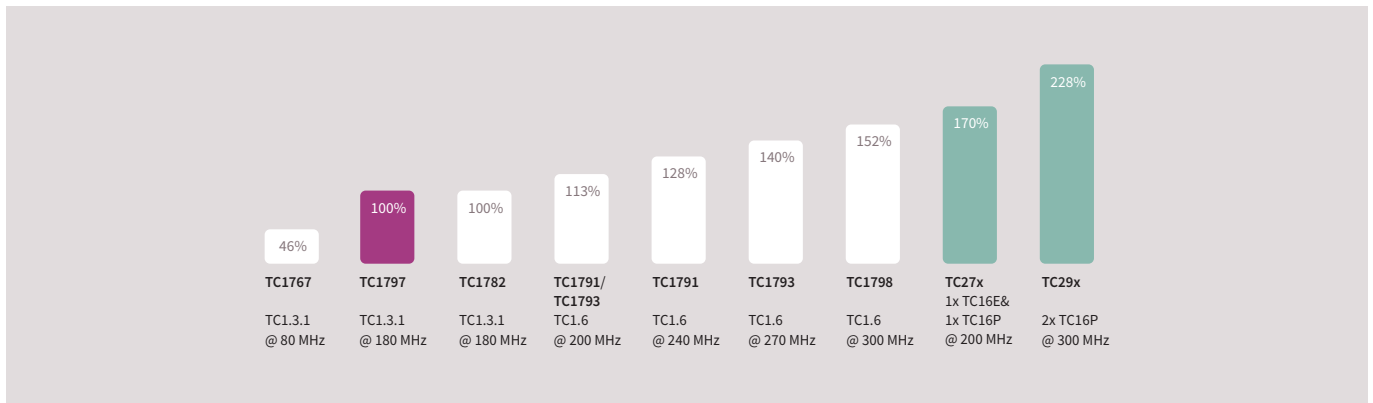

Assuming a multicore performance gain of 1.5 times

## Infineon software product overview

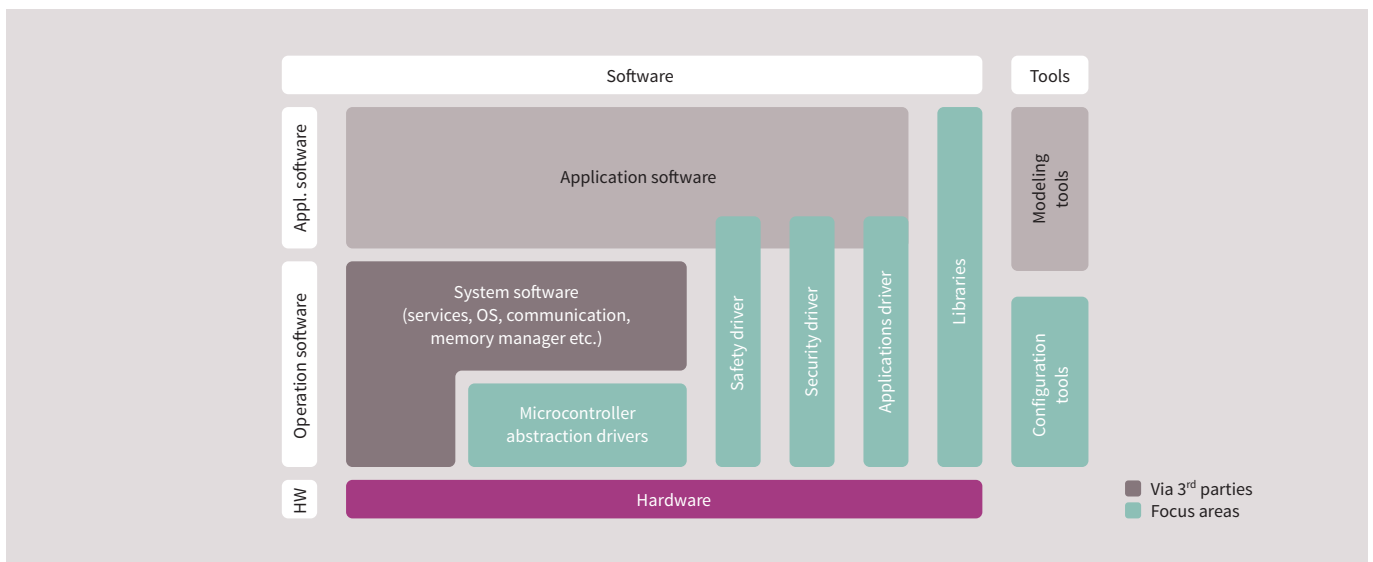

- > Microcontroller abstraction drivers
  - AUTOSAR MCAL
  - DAVE™
- > Safety drivers
  - PRO-SIL™ SafeTcore (AUDO MAX)
  - PRO-SIL™ SafeTlib (AURIX™)
- > Security Driver
  - SHE+ driver

- > System software
- > Configuration tool
  - DAVE™
- > Libraries
  - DSP library
- > Tools
  - MemTool etc.

# Infinion AUTOSAR MCAL drivers

## MC-ISAR product overview

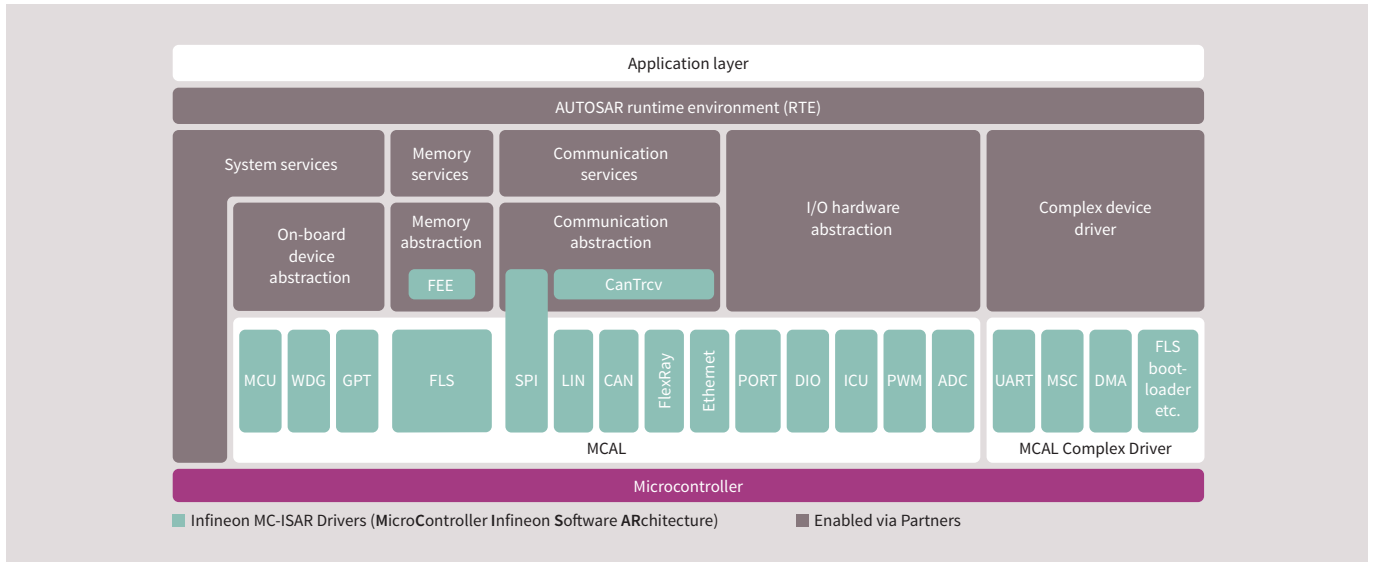

<b>MC-ISAR</b>	<b>MicroController – Infineon Software ARchitecture</b>
MC-ISAR:	MCU, WDG, GPT, SPI, PORT, DIO, ICU, PWM, ADC
MC-ISAR COM Basic:	CAN, CanTrcv, LIN
MC-ISAR COM Enhanced:	FlexRay, Ethernet
MC-ISAR MEM:	FLASH, FEE
MC-ISAR CD:	UART, MSC, DMA, FLSLoader for AURIX™
MC-ISAR DEMOCD:	HSSL, SENT, I2C, STM, DS-ADC, SMU, IOM for AURIX™ as demo code



### > Supported AUTOSAR releases and devices

- V2.0: AUDO NG (TC1796, TC1766)
- V2.1, V3.0: XC2287, AUDO Future (TC1797, TC1767), AUDO S
- V3.1, V3.2: XC2000, AUDO MAX
- V4.03: AUDO MAX
- V3.2, V4.03: AURIX™
- ISO 26262 support

### > Complex driver for non-standardized modules (for TriCore™)

- > CMM L3 process
- > AUTOSAR BSW suite via partners: elektrotbit, vector, KPIT, ETAS
- > Delivery packages include: source code, user manual, Tresos configuration tool

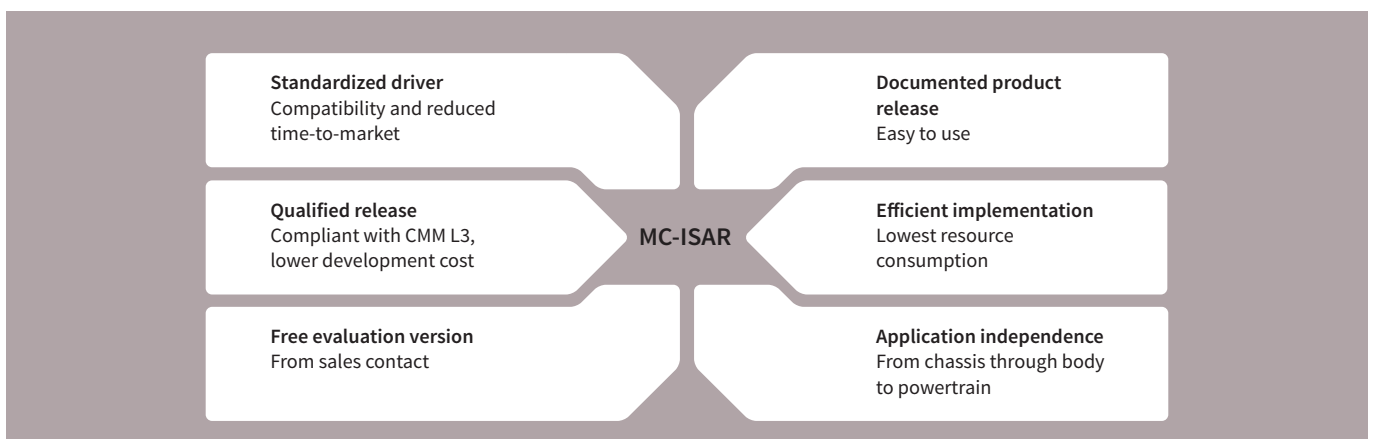

# Development support

## Emulation device

- › Emulation devices (ED) are a very powerful solution for calibration, measurement, rapid prototyping and debugging
- › Emulation logic and RAM are added next to the unchanged Production Device (PD) part on the same chip
- › Cost-optimized PD, feature-rich ED
- › Same package for ED and PD and minimum or no additional external circuitry allows highly cost-optimized ECU design
- › Proven solution with broad tool support by leading automotive and debug tool vendors

### **AURIX™ highlights**

- › Up to 2 Mbyte RAM for calibration with same access speed as on-chip flash
- › Automotive measurement bandwidth (XCP) 15/30 Mbyte/s via regular 2/3-pin DAP interface

## Trace and measurement

Today's vehicles are designed to meet rising market demands for engine performance, engine responsiveness, torque, drivability, fuel economy and emissions. Infineon's proven Multicore Debug Solution (MCDS) enables manufacturers to design and optimize features to support these automotive trends. Unique MCDS features include the fully time-aligned parallel trace of many different on-chip sources and its highly powerful trigger capabilities.

### **Multicore Debug Solution (MCDS)**

#### **Key features**

- › Tracing of CPUs, busses, performance events and peripheral internal states
- › Real-time, cycle-accurate and in parallel
- › Up to 1 Mbyte on-chip trace RAM (40 Gbit/s bandwidth)
- › Very powerful trigger capabilities
- › No additional pins needed besides the DAP interface
- › New Compact Function Trace (CFT) mode for continuous program trace via DAP
- › New fine-grained data trace qualification for automotive measurement

# AURIX™ starter and application kits

Infineon Technologies AG starter kits – 32-bit microcontrollers

## Triboards

Infineon Tricore™ family starter kits are powerful evaluation systems that enable evaluation and development well before the target hardware is available. They offer a solid platform for both hardware and software engineers to evaluate and prototype designs that are closely aligned with their final applications.

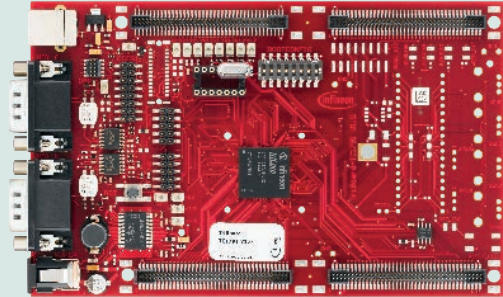

## Application kits

To simplify the development of your own application, the kit comes with a variety of on-board components, including a highly integrated software development environment that gives you everything you need to compile, debug, and flash your AURIX™ multicore application.

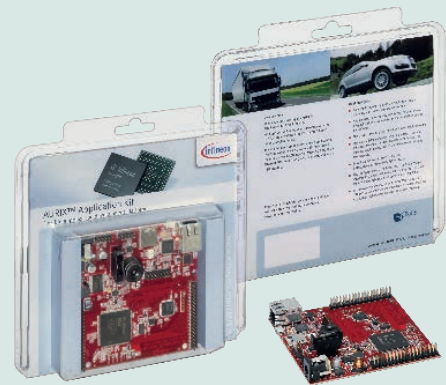

## System application kits

The system application kits provide a quick jump-start to typical microcontroller applications such as motor control, radar etc. These reference design kits provide faster design-in support for end applications by providing a reference board, application software, tooling and documentation.



## ACT- AURIX™ configuration tool

ACT is a powerful tool that helps engineers to jump-start programming of Infineon microcontrollers.

### Key feature

- > Altium TASKING VX TriCore™ lite version including build-in
  - AURIX™ pin mapping incl. interactive package view
  - AURIX™ iLLD (Low-Level Driver)
  - AURIX™ OSEK

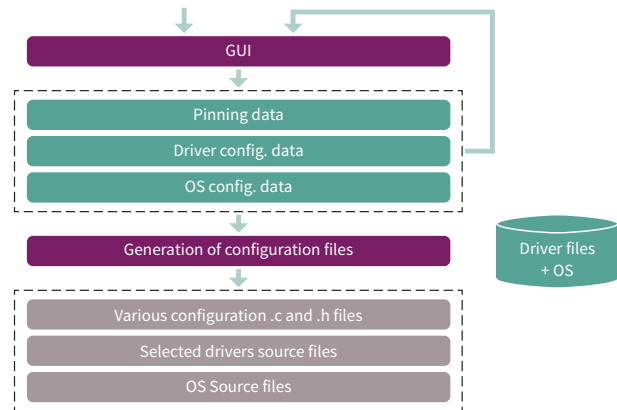

## Free TriCore™ entry tool chain

This free of charge tooling entry tool chain provides all required features to develop and test software for TriCore™ and AURIX™. The tool can be used with all available TriCore™ and AURIX™ starter kits and application boards.

### Key features

- > Eclipse based IDE
- > Project wizard to easy define the project properties for device and board support
- > High-performance GNU C compiler
- > Integrated source level debugger
- > On-chip flash programming support

For further information on TriCore™ Tools, please visit: [www.infineon.com/tricore-tools](http://www.infineon.com/tricore-tools)

## Preferred Design Houses (PDH)

Optimized open-market customer support set up for systems using AURIX™, including software and other Infineon products such as power products, sensor products and modules. They are trained to provide application- and product-specific support.

<b>Classic</b> (Free of charge)	<ul style="list-style-type: none"> <li>&gt; 1<sup>st</sup> level customer support ensuring Infineon products/solutions</li> <li>&gt; Technical interface and support to the customer</li> </ul>	<ul style="list-style-type: none"> <li>&gt; Driving design @ customer</li> <li>&gt; Basic training for design teams @ customer</li> <li>&gt; 24 h response time to the customer</li> </ul>
<b>Premium</b> (Consultancy mode)  To be agreed between customers and PDH	<ul style="list-style-type: none"> <li>&gt; Project management &amp; project-specific application support</li> <li>&gt; Specification of general SW architecture, defining required layers, control and data flow structure etc.</li> <li>&gt; Specification and implementation of custom device drivers</li> <li>&gt; Optimization of software components with regard to speed/code size</li> </ul>	<ul style="list-style-type: none"> <li>&gt; Software testing</li> <li>&gt; Support of project-specific functional safety engineering</li> <li>&gt; Project-specific support of security solution</li> <li>&gt; Safety support</li> <li>&gt; Security support</li> <li>&gt; Multicore support</li> </ul>

Design houses:

For more information, please visit: [www.infineon.com/pdh](http://www.infineon.com/pdh)



# AURIX™ for powertrain applications

## Energy efficiency for combustion engine vehicles

Electronic automotive components are key to raising fuel efficiency levels and cutting emissions. The latest environment protection agency standards – Euro 5 and Euro 6 for passenger cars and Euro 3 and Euro 4 for motorcycles – are driving developments in advanced engine management. TriCore™ based products can be found in improved combustion technologies such as Homogeneous Charge Compression Ignition (HCCI) as well as in direct injection, smart turbocharger and valve actuation applications. They are also ideal for a range of innovative transmission technologies such as Double Clutch Transmission (DCT) and modern Continuous Variable Transmission (CVT).

## Driving hybrid and electrification

While excelling in fuel economy, being fun-to-drive and reducing CO<sub>2</sub> emissions, Hybrid Electric Vehicles (HEV) and Electric Vehicles (EV) have the drawbacks of higher cost, limited drive-range and safety concerns (e.g. risk of battery over-charging). TriCore™ products, with their high performance, functional integration and application-based SW support, are the ideal solution for (H)EV motor drives. TriCore™ offers less than 3% CPU load at 300 MHz frequen-

cy, for the complete Field-Oriented Control (FOC) algorithm. TriCore™ AURIX™ family offers multicore architecture, allowing inverter control, hybrid torque management and DC/DC conversion to be done within one single microcontroller. Nevertheless, the TriCore™ AURIX™ family has built-in resolver functionality, saving customers the cost of implementing an external resolver IC.

Often seen as master micro in battery balancing topology, the TriCore™ AURIX™ family proposes a 32-bit standby domain combined with an integrated 8-bit standby controller, essential for battery balancing under low power mode (e.g. holiday parking). Infineon is market leader in offering Hardware Security Module (HSM), a feature that prevents the main CPU from illegal manipulation, making the billing for battery charging more trustworthy.

## AURIX™ security hardware

Infineon's AURIX™ 32-bit microcontroller family offers a wide portfolio of compatible devices, with embedded Hardware Security Module (HSM), which offer cost-efficient solutions for all typical automotive security applications.



### Hardware Security Module (HSM)

HSM provides a secure computing platform, consisting of a 32-bit CPU, special access-protected memory for storing the cryptographic key and the unique subscriber identifiers, a hardware accelerator for the state-of-the-art AES-128 encryption that can be operated in different modes and specific hardware for generation of random numbers. A firewall separates HSM from the rest of AURIX™ microcontroller.

- › A highly flexible and programmable solution
- › AES-128 HW accelerator matching performance for automotive protocols
- › Crypto- and Algorithm Agility by software
- › AIS31 compliant True Random Number Generator (TRNG) with high random entropy over lifetime

### Customer benefits

- › **Secure platform** – HSM provides a secure platform, separated from the rest of the microcontrollers by a firewall, thereby creating a trusted execution environment.
- › **Security standard compliance** – AURIX™ HSM fulfills SHE HIS and Evita Medium standards as well as provide some additional functionalities.
- › **Backward compatibility** – AURIX™ security solutions are backward compatible to security SHE HIS implementations in previous TriCore™ based microcontroller families.
- › **Security differentiation** - customized secure OEM or Tier1 crypto apps can be processed within trusted HSM execu-

tion environment and therefore allow independent HSM specific SW code review in reference to the huge application host SW from multiple parties. This helps to harden the security level by reliably avoiding potential security backdoors.

- › **Convergence of security and safety** – AURIX™ microcontrollers address both functional safety as well as IT-security requirements, making sure those are properly integrated and not conflicting with one another.
- › **Secure process** – Infineon can provide a secure personalization flow. 1<sup>st</sup> personalization step usually happens at the Tier1, where initial HSM SW and optional transportation key(s) are injected to the ECU. 2<sup>nd</sup> personalization step happens at the OEM, where a car specific Individual key(s) are injected. AURIX™ HSM offers device specific, individual random read-only key. Read-only key can be used for injected keys and make them invisible for the application SW layer.
- › **Secure failure analysis** – for the purpose of preventing unpermitted debug access, AURIX™ HSM offers 256-bit password for debugger access protection. It is possible to create car specific debugger password, which can be stored in OEM/Tier1 data base or generated by secret algorithm. Destructive debugger entry functionality opens debugger access but initiates a persistent destructive action – device gets inoperable in native ECU car environment.

# Gasoline direct injection

## Application example

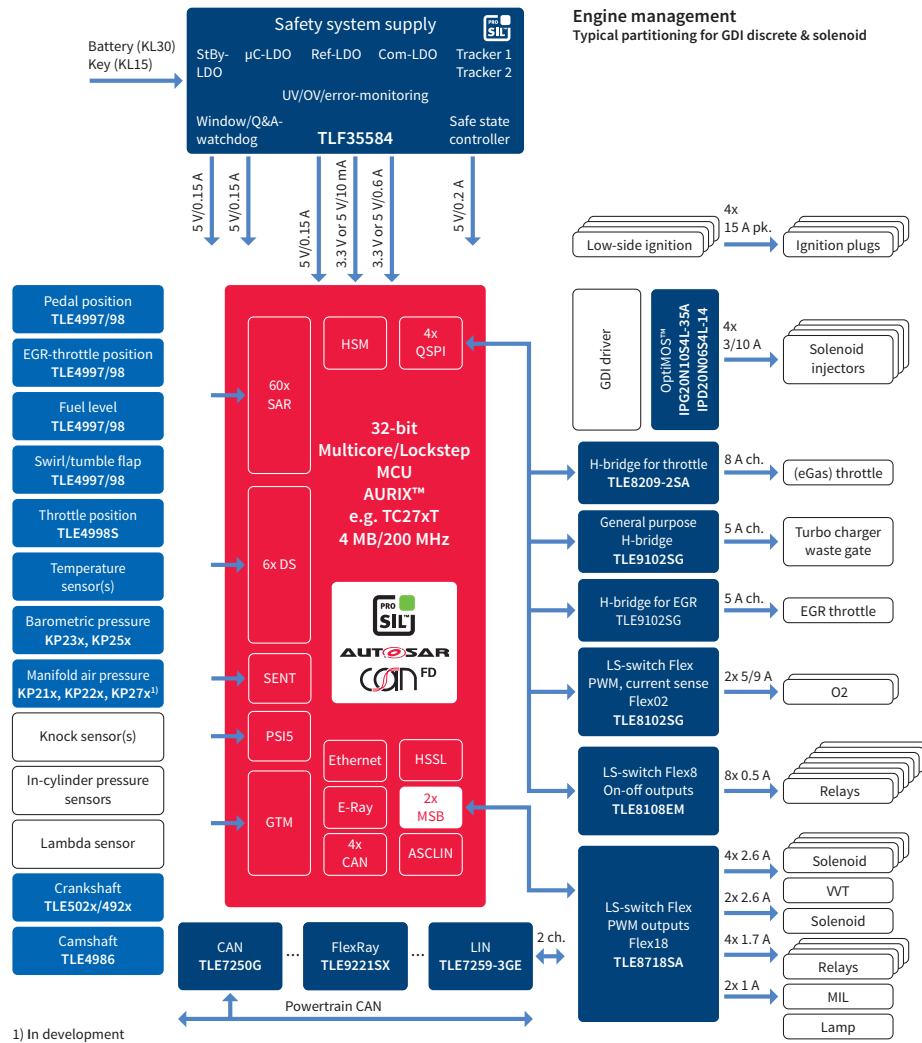

The new TriCore™ family AURIX™ with state-of-the-art safety features enables systems to achieve the highest safety level up to ASIL-D. The scalable AURIX™ family includes the GTM, the de-facto industry standard timing module that supports highly complex engine management, while meeting the market's most stringent emissions regulations.

### Application features

- › Direct injection
- › Scalable software-based knock detection
- › Variable valve control
- › Throttle and EGR control
- › Turbo charging
- › Catalyist after treatment
- › Start/stop system

### System benefits

- › Microcontroller with best-in-class real-time performance
- › Scalable platform – performance, memory size and I/Os
- › Committed to reduce CO<sub>2</sub> by 20%
- › Anti-theft protection and tuning protection
- › Increased knock detection accuracy via DS-ADC
- › Enhanced communication (Ethernet)
- › Dedicated peripherals for powertrain

### Suggested products

- › TC27x – TriCore™ 32-bit microcontroller
- › TC26x – TriCore™ 32-bit microcontroller



# Gasoline multi-port injection – discrete solution

## Application example

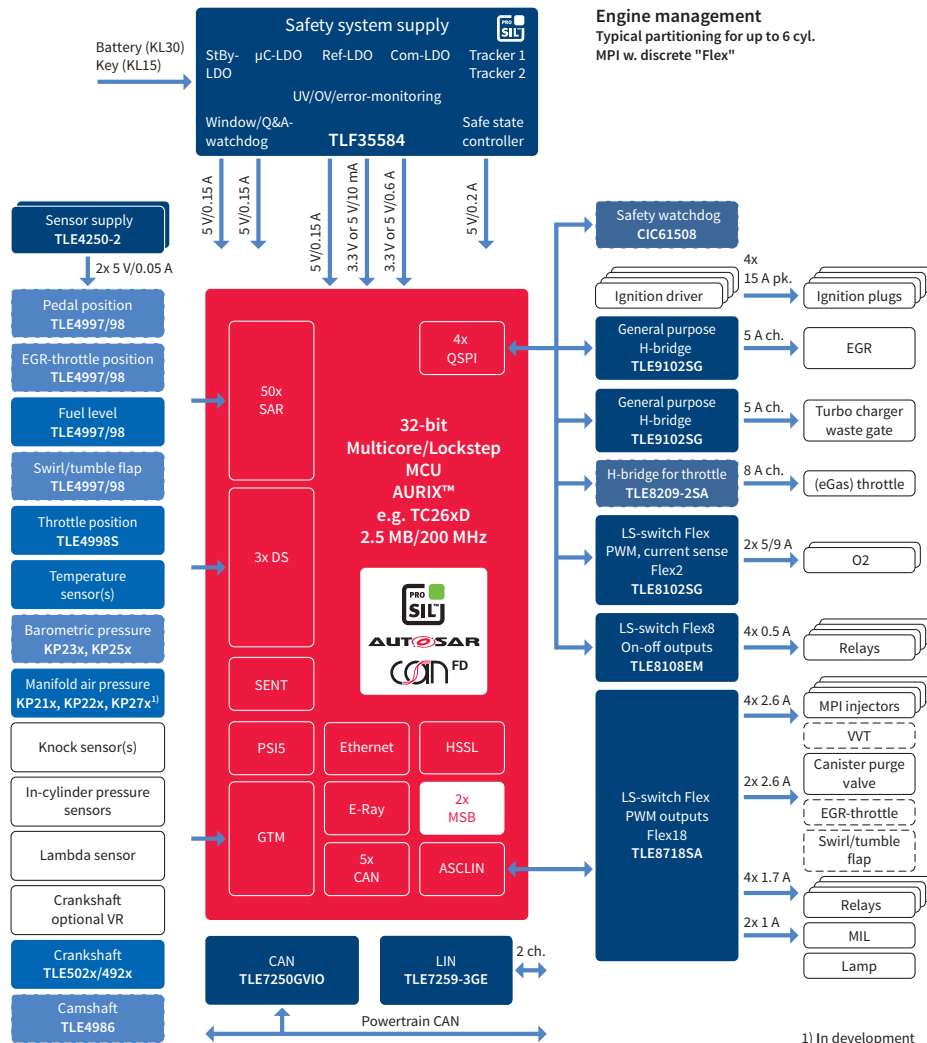

The new TriCore™ family AURIX™ with state-of-the-art safety features enables systems to achieve the highest safety level up to ASIL-D. The scalable AURIX™ family includes the GTM, the de-facto industry standard timing module that supports highly complex engine management, while meeting the market's most stringent emissions regulations.

### Application features

- › Gasoline port injection
- › Scalable software-based knock detection
- › Throttle and EGR control
- › Catalyst after treatment
- › Start/stop systems
- › Cost-optimized for entry segment

### System benefits

- › Scalable platform – performance, memory size and I/Os
- › Single voltage supply (EVR)
- › Focus on reducing CO<sub>2</sub>
- › Easy migration from ultra low-end to mid-range applications
- › Best tool/partner support for all development phases within V-cycle

### Suggested products

- › TC265 – TriCore™ 32-bit microcontroller
- › TC264 – TriCore™ 32-bit microcontroller



# Diesel direct injection

## Application example

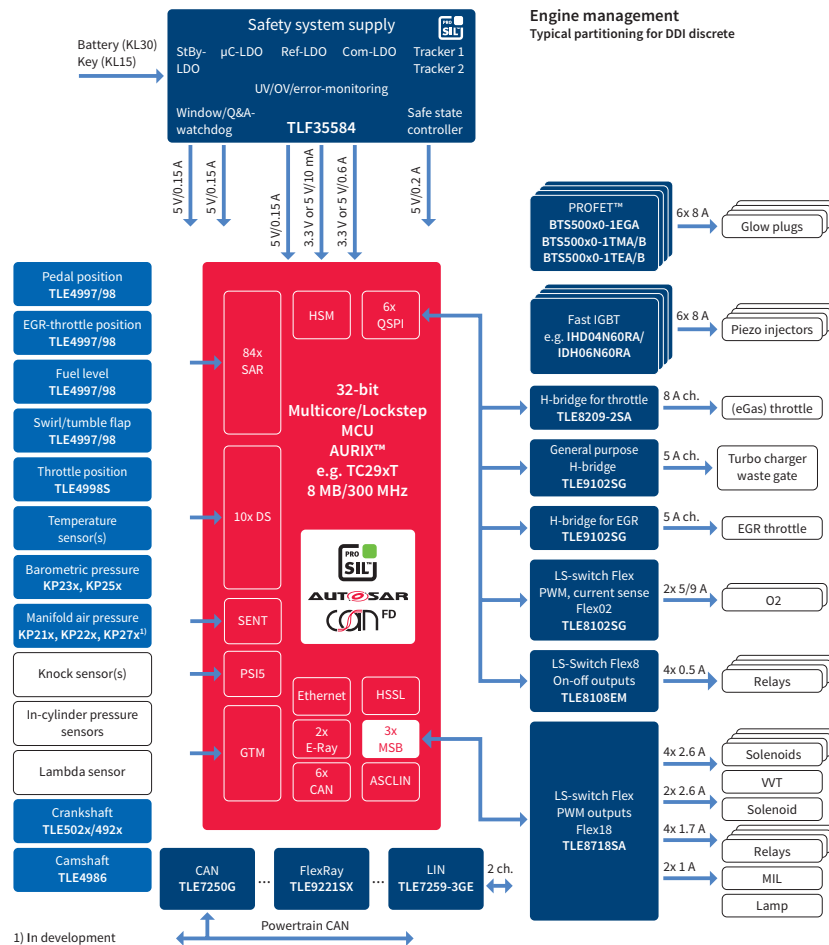

The new TriCore™ family AURIX™ with state-of-the-art safety features enables systems to achieve the highest safety level up to ASIL-D. The scalable AURIX™ family includes the GTM, the de-facto industry standard timing module that supports highly complex engine management, while meeting the market’s most stringent emissions regulations.

### Application features

- › Direct injection (piezo/magnetic)
- › In-cylinder pressure measurement
- › Hardware-supported security enhancements
- › Throttle and EGR control
- › Turbo charging
- › Diesel particulate filter
- › ‘Blue’ after-treatment support (e.g. urea-based SCR)

### Suggested products

- › TC29x – TriCore™ 32-bit microcontroller
- › TC27x – TriCore™ 32-bit microcontroller

### System benefits

- › Microcontroller with best-in-class real-time performance
- › Scalable platform – performance, memory size and I/Os
- › Committed to reduce NOx and particulate matter in line with Euro 6 standard
- › Hardware-supported IP/anti-theft protection and tuning protection
- › Increased accuracy with in-cylinder pressure sensing via DS-ADC
- › Enhanced communication (Ethernet)
- › Dedicated peripherals for powertrain



# Automatic transmission – hydraulic control

## Application example

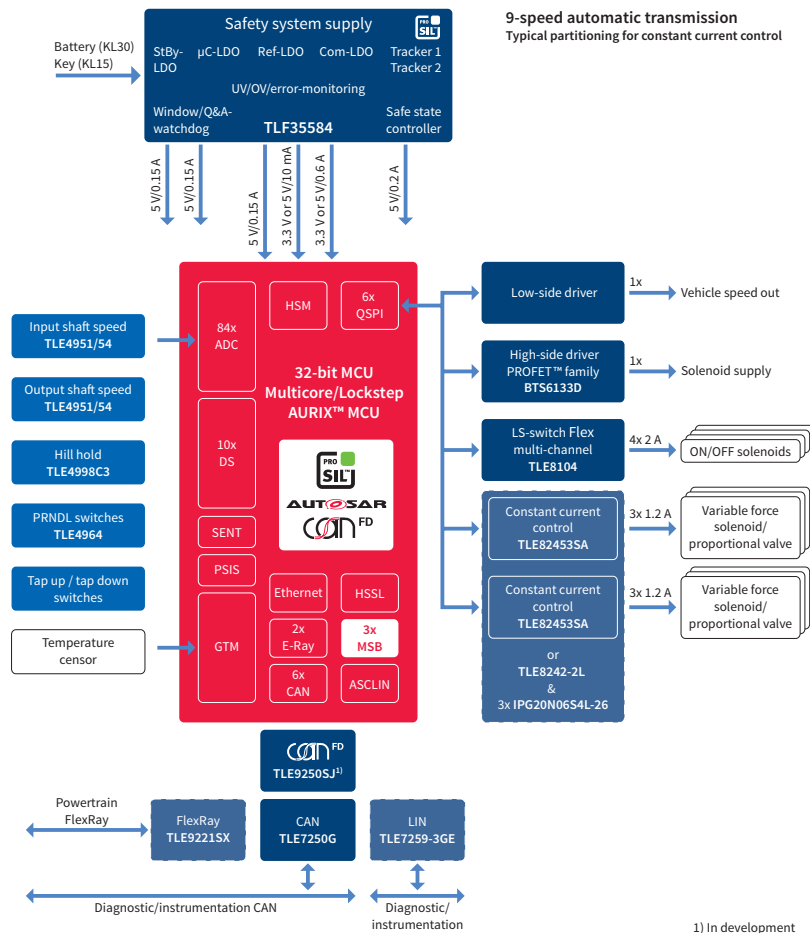

The new TriCore™ family AURIX™ with state-of-the-art safety features enables systems to achieve the highest safety level up to ASIL-D. The rich scalability of the AURIX™ family permits a platform approach that meets the needs of a range of transmission system demands. Furthermore, the hot temperature package and bare die solutions enable AURIX™ to be used in both attached and integrated control units.

### Application features

- › Smooth gear shifting
- › Closely coupled with engine control via high-speed CAN/CAN-FD/FlexRay link
- › Support of four 3-phase DC-brushless E-drives
- › TC270: high microcontroller junction bare die temperature
- › TC275/TC277: extended ambient temperature range to meet harsh environment requirements

### Suggested products

- › TC29x – TriCore™ 32-bit microcontroller
- › TC27x – TriCore™ 32-bit microcontroller
- › TC270 – Bare die TriCore™ 32-bit microcontroller

### System benefits

- › Improved and fast clutch control
- › Supports Safety Level up to ASIL-D
- › Security module HSM to prevent tampering
- › Hot bare die supports modular temperature-optimized TCU design
- › Hot bare die capabilities enable microcontrollers to be placed wherever they are needed in the system
- › Scalable product offering ensures perfect fit for individual application needs



# Dry double clutch transmission – hydraulic control

## Application example

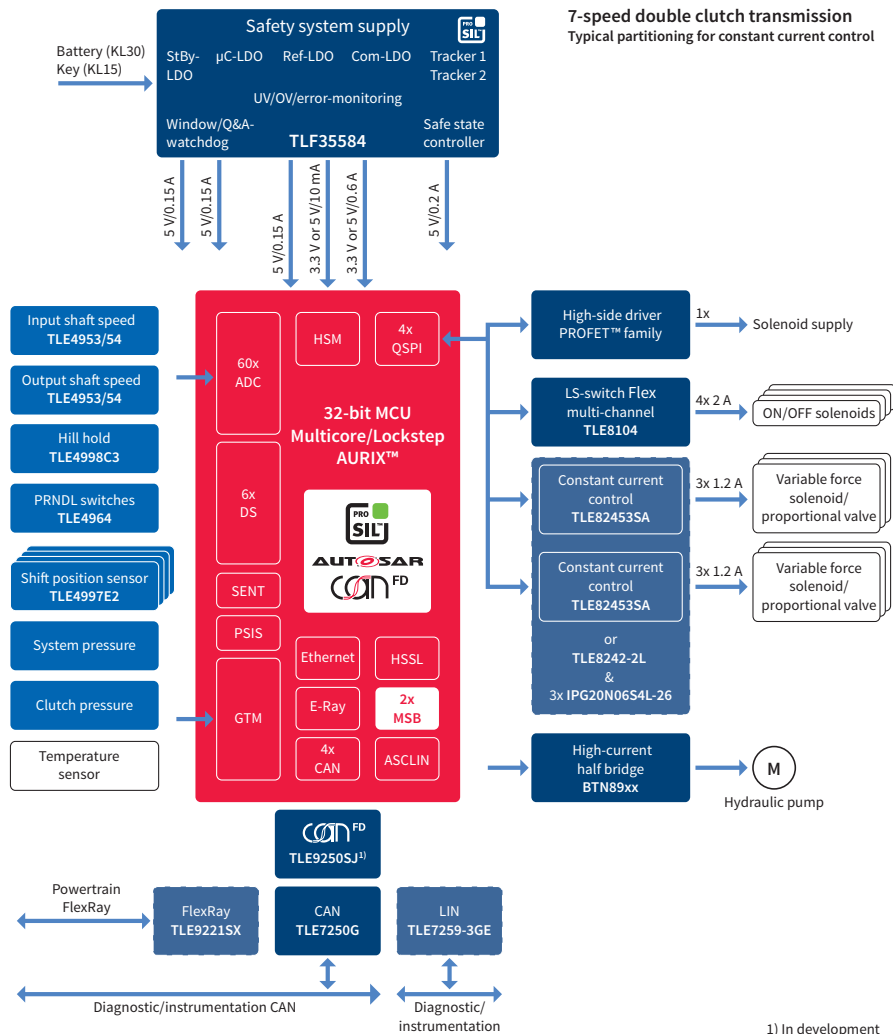

The new TriCore™ family AURIX™ with state-of-the-art safety features enables systems to achieve the highest safety level up to ASIL-D. The rich scalability of the AURIX™ family permits a platform approach that meets the needs of a range of transmission system demands. Furthermore, the hot temperature package and bare die solutions enable AURIX™ to be used in both attached and integrated control units.

### Application features

- › Ultra-fast gear switching
- › Closely coupled with engine control via high-speed CAN/CAN-FD/FlexRay link
- › Support of four 3-phase DC-brushless E-drives (dry-DCT)
- › High microcontroller junction bare die temperature

### Suggested products

- › TC275 – TriCore™ 32-bit microcontroller
- › TC270 – Bare die TriCore™ 32-bit microcontroller

### System benefits

- › Improved fast clutch control
- › Supports safety level up to ASIL-D
- › Feature set optimized for wet and dry DCT designs
- › Continuous torque on wheels ensures a sportive driving experience
- › Hot bare die capabilities enable microcontrollers to be placed directly where they are needed in the system
- › Hot bare die supports modular temperature-optimized TCU designs



# Dry double clutch transmission – electrical control

## Application example

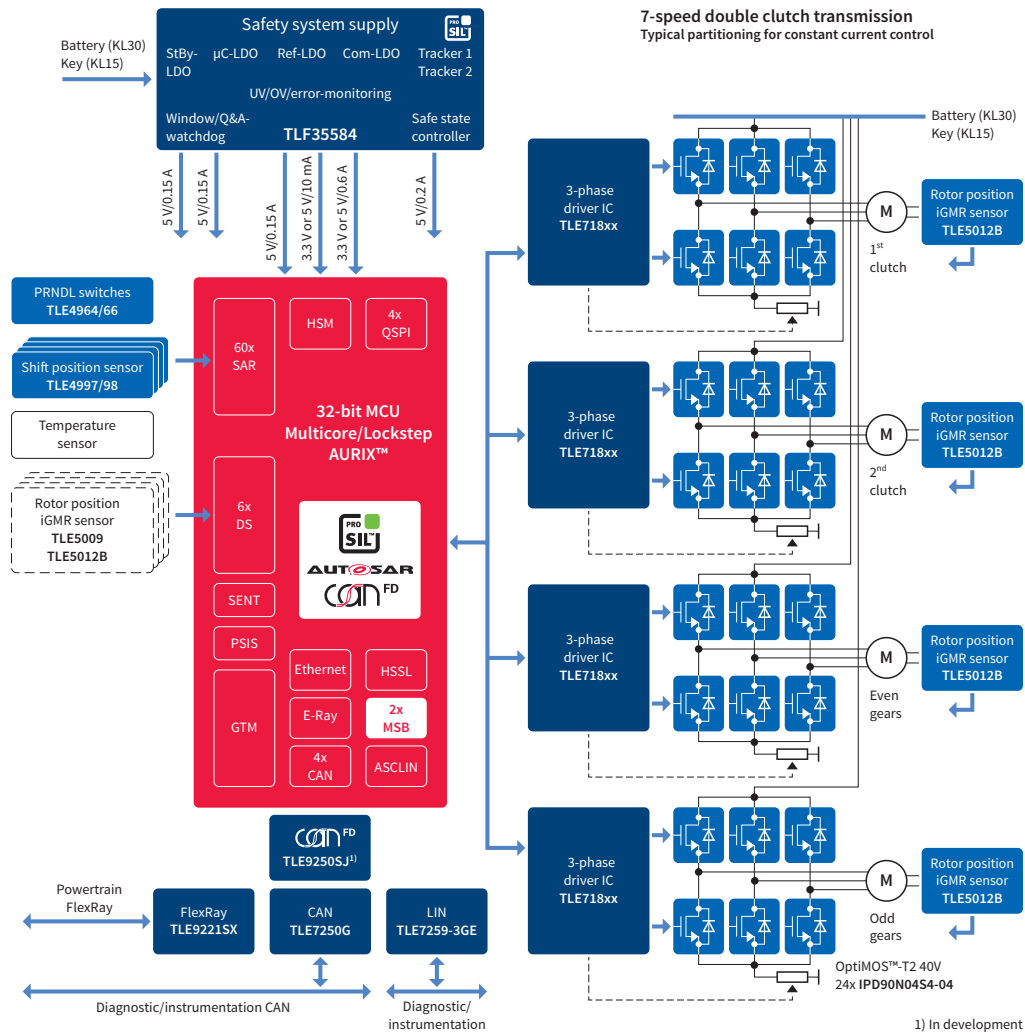

The new TriCore™ family AURIX™ with state-of-the-art safety features enables systems to achieve the highest safety level up to ASIL-D. The rich scalability of the AURIX™ family permits a platform approach that meets the needs of a range of transmission system demands. Furthermore, the hot temperature package and bare die solutions enable AURIX™ to be used in both attached and integrated control units.

### Application features

- › Ultra-fast gear switching
- › Closely coupled with engine control via high-speed CAN/CAN-FD/FlexRay link
- › Support of four 3-phase DC-brushless E-drives (dry-DCT)
- › High microcontroller junction bare die temperature

### Suggested products

- › TC275 – TriCore™ 32-bit microcontroller
- › TC270 – Bare die TriCore™ 32-bit microcontroller

### System benefits

- › Improved fast clutch control
- › Supports safety level up to ASIL-D
- › Feature set optimized for wet and dry DCT designs
- › Continuous torque on wheels ensures a sportive driving experience
- › Hot bare die capabilities enable microcontrollers to be placed directly where they are needed in the system
- › Hot bare die supports a modular temperature-optimized TCU design
- › Infineon e-motor driver



# Integrated (H)EV control

## Application example

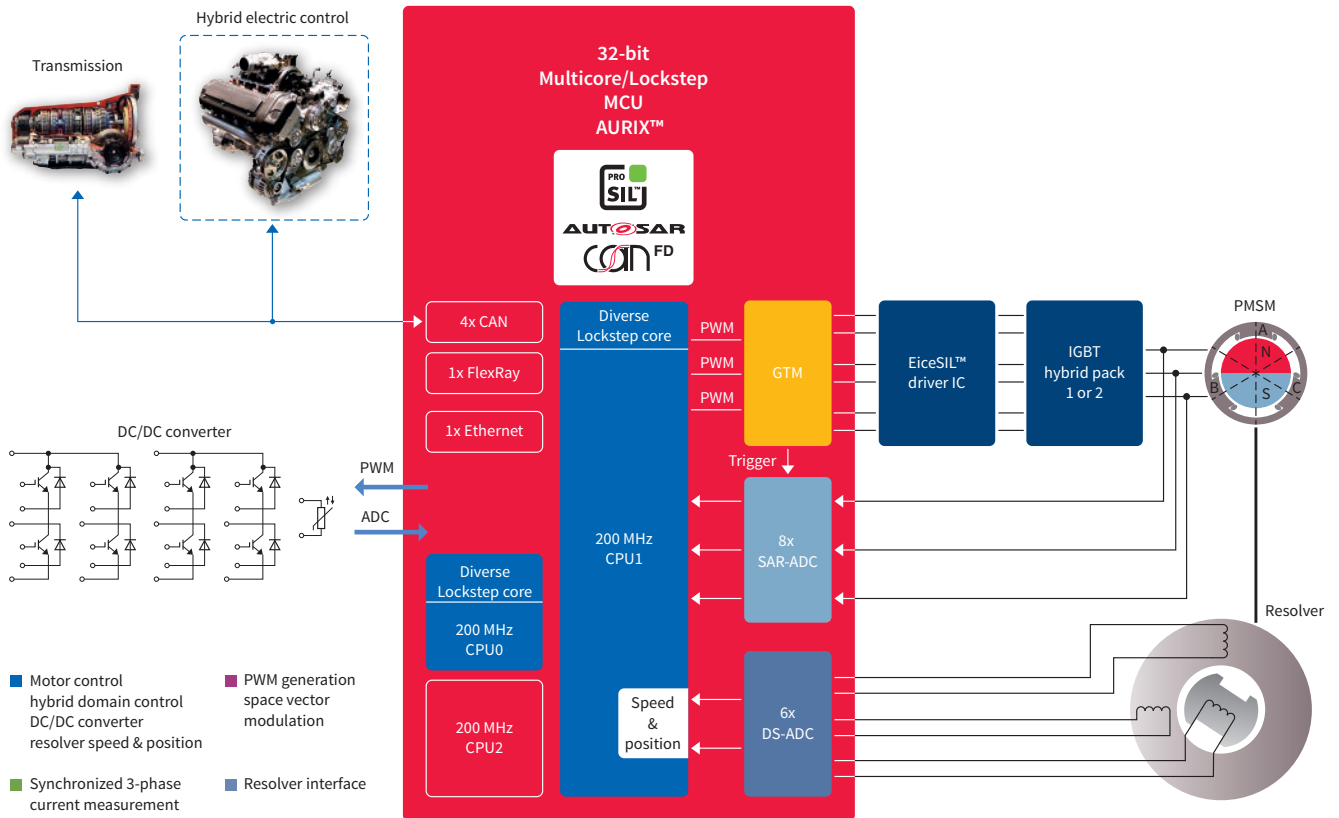

The inverter controls the electric motor via an electric drivetrain. It resembles the Engine Management System (EMS) in vehicles with an internal combustion engine. It is seen as a key component in determining (H)EV drive behavior. The inverter captures energy released through regenerative braking and feeds this back to the battery. As a result, the range of the vehicle is directly related to the efficiency of the inverter. A safe, highly efficient inverter control system is crucial to the quality of driving.

### Application features

- > Multicore & lockstep architecture
- > DS-ADC-enabled direct resolver-to-microcontroller
- > Superior performance
- > Customized PWM pattern generation

### System benefits

- > ISO 26262 ASIL-C/D compliant
- > No resolver IC needed, lower system cost
- > Enables sub-system integration (driving HCU + inverter + DC/DC)
- > Fine motor tuning

### Suggested products

- > TC29x – TriCore™ 32-bit microcontroller
- > TC27x – TriCore™ 32-bit microcontroller

# (H)EV battery management system

Application example

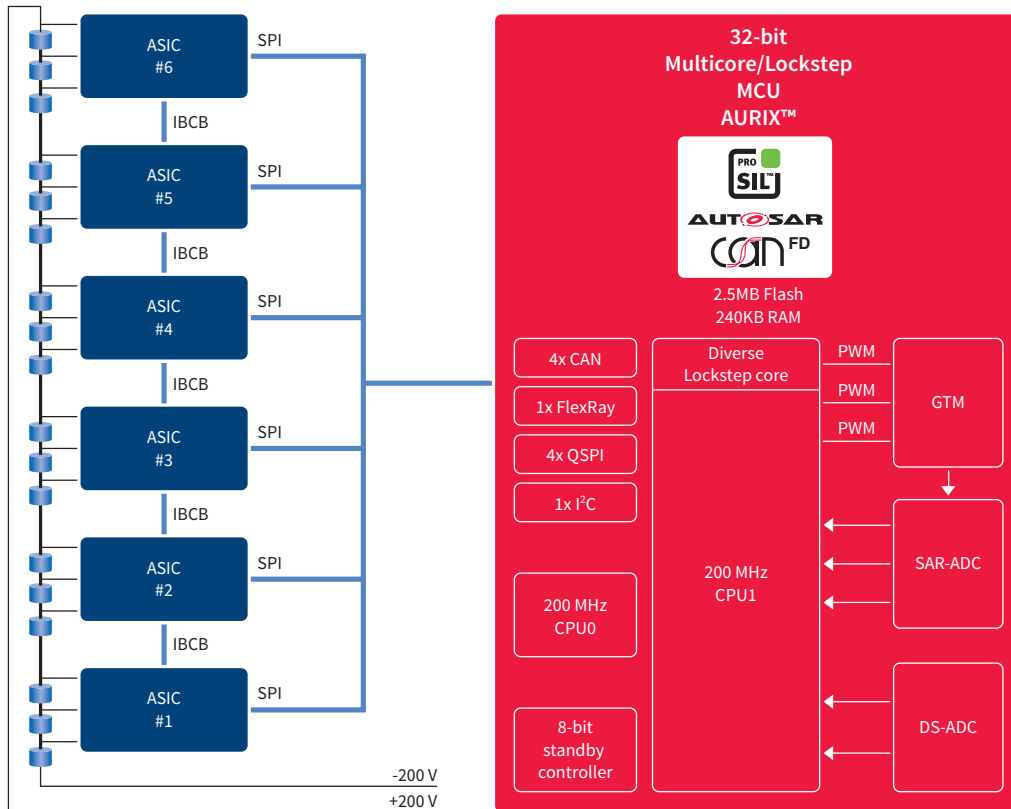

The battery management system controls the battery state during charging and discharging. Intelligent functionality is needed to extend the battery lifetime, which has a considerable impact on the total cost of ownership. The State of Health (SoH), State of Charge (SoC) and Depth of Discharge (DoD) of the battery is permanently monitored.

## Application features

- > Multicore & lockstep core architecture
- > Fast communication interface
- > Integrated low-power 8-bit standby controller
- > HW Security Module (HSM)

## System benefits

- > ISO 26262 compliant
- > Ring topology in event of failure
- > Balancing & monitoring over long parking period
- > Charge-billing verification

## Suggested products

- > TC27x – TriCore™ 32-bit microcontroller
- > TC26x – TriCore™ 32-bit microcontroller



# AURIX™ for safety applications

## AURIX™ made for safety

The AURIX™ architecture ISO 26262 compliant process is designed to efficiently meet ASIL-D on an application level. The platform uses up to 2 cores in TriCore™ diverse lockstep core technology, a diverse lockstep architecture combined with cutting-edge safety technology, such as safe internal communication buses or distributed memory protection system. Innovative encapsulation techniques allow the integration of software with various safety levels (QM to ASIL-D) from different sources, thereby significantly reducing system complexity. Thanks to this optimized approach, multiple applications and operating systems (such as steering, braking, airbag and advanced driver assistance systems) are seamlessly hosted on an unified platform. This leads to productivity gains of up to 30%, resulting in a smaller development outlay and reduced time-to-market for our customers.

Furthermore, Infineon extends the microcontroller safety roadmap with devices dedicated to the Advanced Driver Assistance System (ADAS) segment, such as radar or camera applications. Innovation has been focused on system partitioning in order to further integrate system functionality and consequently reduce the complexity and area, providing our customers with highly optimized solutions. The new devices include high-speed interfaces, integrated hardware acceleration and enhanced ECU validation and instrumentation tools. All ADAS devices support ISO 26262 safety methodology, meaning that they can be involved in automatic decisions to assist drivers, such as emergency braking.

## AURIX™ made for scalability

Thanks to its market-leading expertise, Infineon has translated customer demands for individual scalability into a universal product roadmap. Designed to optimize its customers' investment, the AURIX™ family comes with a comprehensive range of fully modular components, thereby ensuring long-term design flexibility. The devices range in the ultra high-end from a 300 MHz triple-core device

with 8 MB of embedded Flash to a 200 MHz triple core with 4 MB of embedded Flash to a 200 MHz dual-core device with 2.5 MB of embedded Flash right down to 130 MHz and 80 MHz single-core and single-core lockstep devices with 1.5 MB, 1 MB and 0.5 MB of embedded Flash. The package portfolio includes a BGA-516 package with a ball-compatible BGA-292 package (I/O subset), and compatible QFP-176, QFP-144, QFP-100 to QFP-80 packages.

# Chassis domain control

## Application example

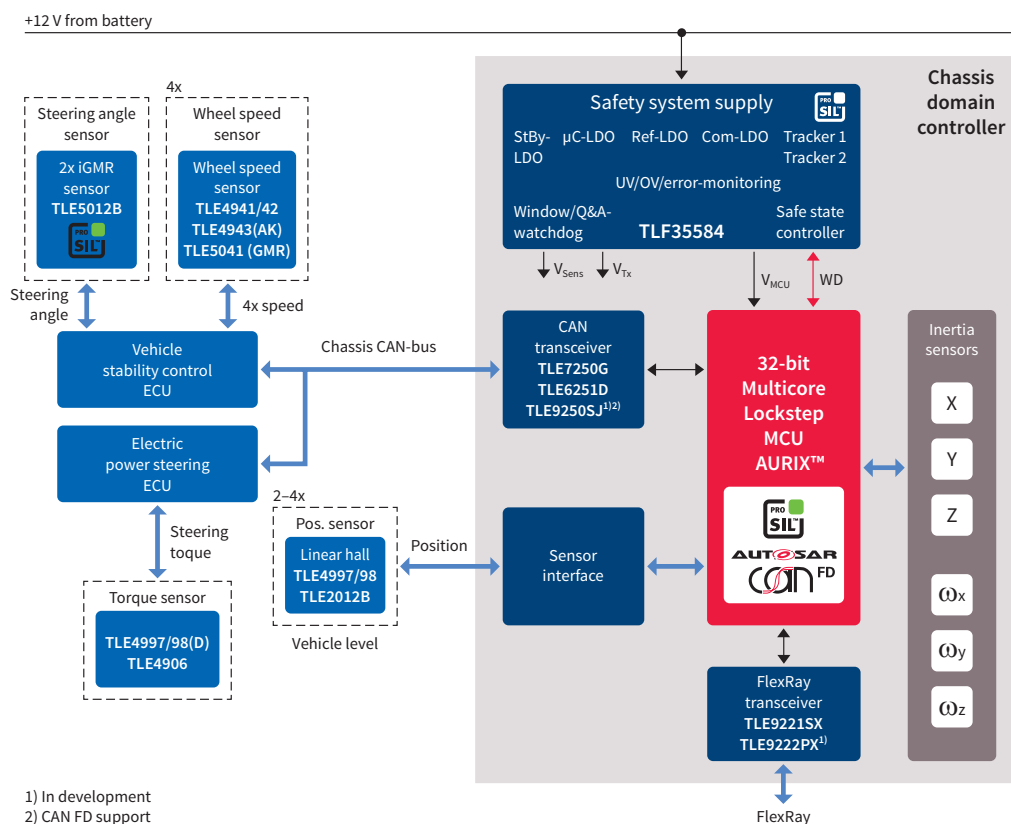

The new TriCore™ family AURIX™ with state-of-the-art safety features enables systems to achieve the highest safety level ASIL-D, which is already required in contemporary domain control systems. The latest diverse lockstep technology with clock delay (diverse lockstep core) reduces the software overhead significantly and enables fast time-to-market. Thanks to a scalable multicore system and innovative encapsulation techniques, this supports the integration of software with mixed-criticality levels from different sources, thereby allowing multiple applications and operating systems to be seamlessly hosted on an unified platform.

### Application features

- > TriCore™ DSP functionality
- > Best-in-class performance: triple TriCore™ with up to 300 MHz per core
- > Supporting floating point and fix point with all cores
- > Up to 2.7 MB of internal RAM
- > Communication peripherals: CAN, LIN, FlexRay, Ethernet
- > Innovative single supply 5 V or 3.3 V
- > External memory interface
- > ISO 26262 conformance to support safety requirements up to ASIL-D
- > Availability of AUTOSAR 4.x

### System benefits

- > Advanced communication with FlexRay and Ethernet
- > Highest available performance with integrated FPU
- > Flexible DMA unit
- > Scalability over Flash, RAM and peripherals
- > Proven safety concept to support ISO 26262
- > Innovative supply concept leads to best-in-class power consumption

### Suggested products

- > TC29x
- > TC27x



# Electric Power Steering (EPS)

## Application example

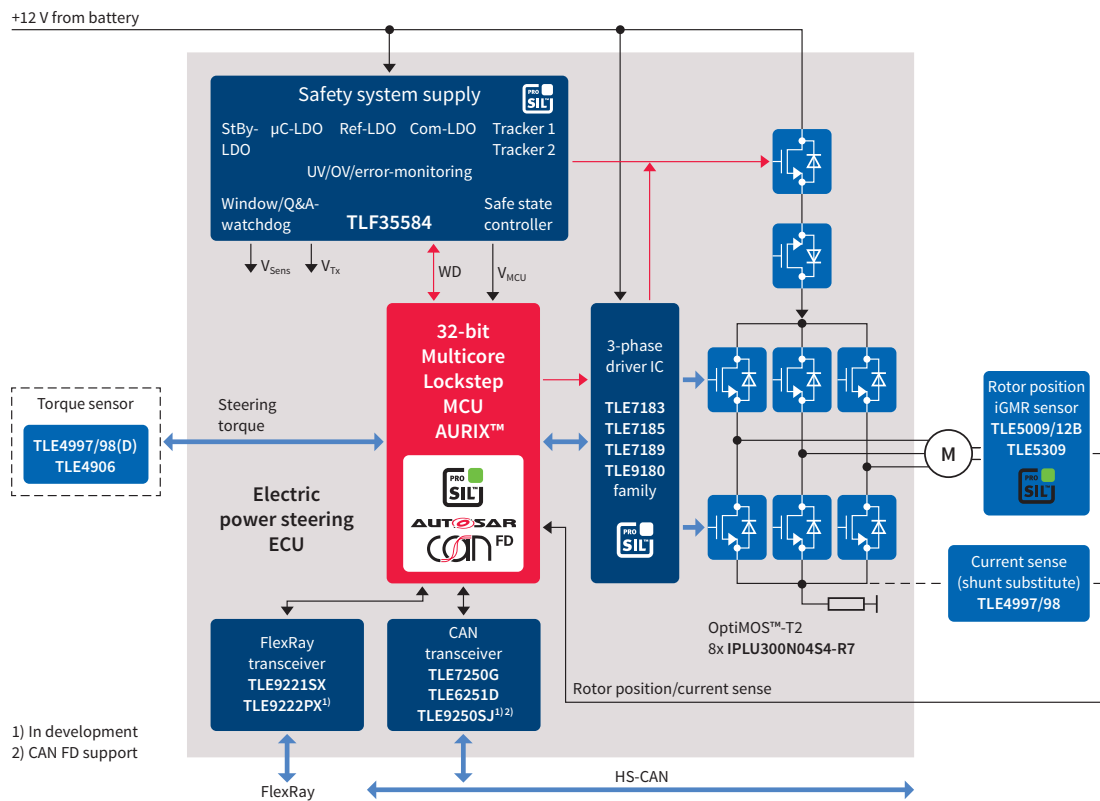

The new TriCore™ family AURIX™ with state-of-the-art safety features enables systems to achieve the highest safety level ASIL-D, which is already required in contemporary steering systems.

The latest diverse lockstep technology with clock delay (diverse lockstep core) reduces the software overhead significantly and enables fast time-to-market.

Its rich scalability meets a variety of different electric power steering system demands.

### Application features

- > Flash 512 KB–8 MB
- > Performance from 133 MHz–3x 300 MHz
- >  $T_a = -40\text{ °C} \dots 145\text{ °C}$
- > Dedicated peripheral set: LIN, CAN, SPI, FlexRay, Ethernet
- > Advanced timer unit for totally flexible PWM generation and hardware input capture
- > Redundant flexible 12-bit ADC
- > Hardware SENT interface for low CPU load
- > Hardware-focused safety concept for reduced SW overhead
- > Safety software: Infineon SafeTcore library
- > ISO 26262 conformance to support safety requirements up to ASIL-D
- > Availability of AUTOSAR 4.x

### System benefits

- > Scalability over Flash, RAM and peripherals offering the best cost-performance ratio
- > Serves all kinds of EPS systems, such as column or belt drive
- > Proven safety concept to support ISO 26262
- > Innovative supply concept leads to best-in-class power consumption

### Suggested products

- > TC26x
- > TC23x
- > TC22x



# Active suspension control system

## Application example

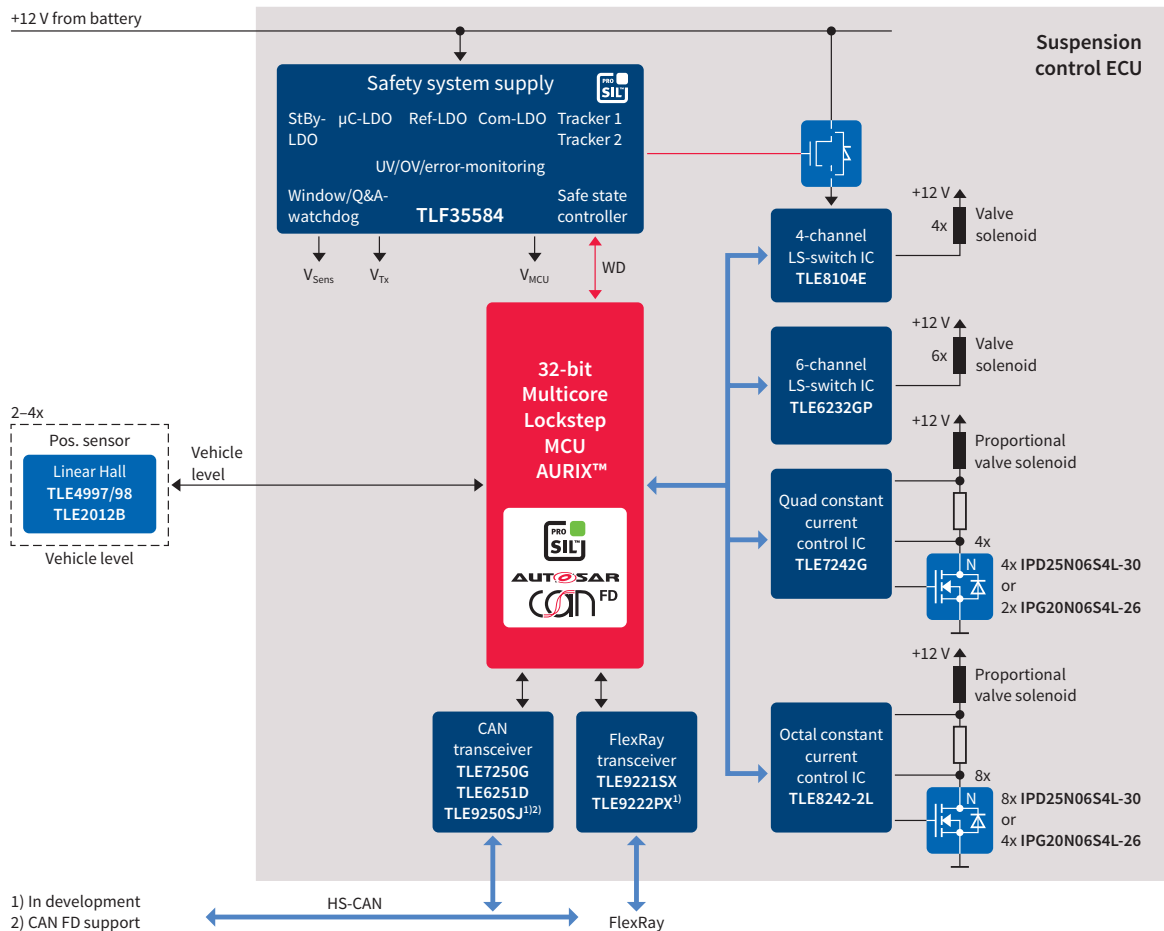

The new TriCore™ family AURIX™ with state-of-the-art safety features enables systems to achieve the highest safety level ASIL-D, which is already required in contemporary suspension systems.

The latest diverse lockstep technology with clock delay (diverse lockstep core) reduces the software overhead significantly and enables fast time-to-market.

The scalability supports an optimized fit in order to meet different OEM specifications.

### Application features

- > TriCore™ DSP functionality
- > Best-in-class performance: triple TriCore™ with up to 300 MHz per core
- > Supporting floating point and fix point with all cores
- > Communication peripherals: CAN, LIN, FlexRay, Ethernet
- > Innovative single supply 5 V or 3.3V
- > Wide range of packages from 80-pin – 516-pin
- > ISO 26262 conformance to support safety requirements up to ASIL-D
- > Availability of AUTOSAR 4.x

### System benefits

- > Scalability over Flash, RAM and peripherals offering the best cost-performance ratio
- > Proven safety concept to support ISO 26262
- > Innovative supply concept leads to best-in-class power consumption and saves external component costs

### Suggested products

- > TC27x
- > TC26x
- > TC23x
- > TC22x



# Advanced airbag system

## Application example

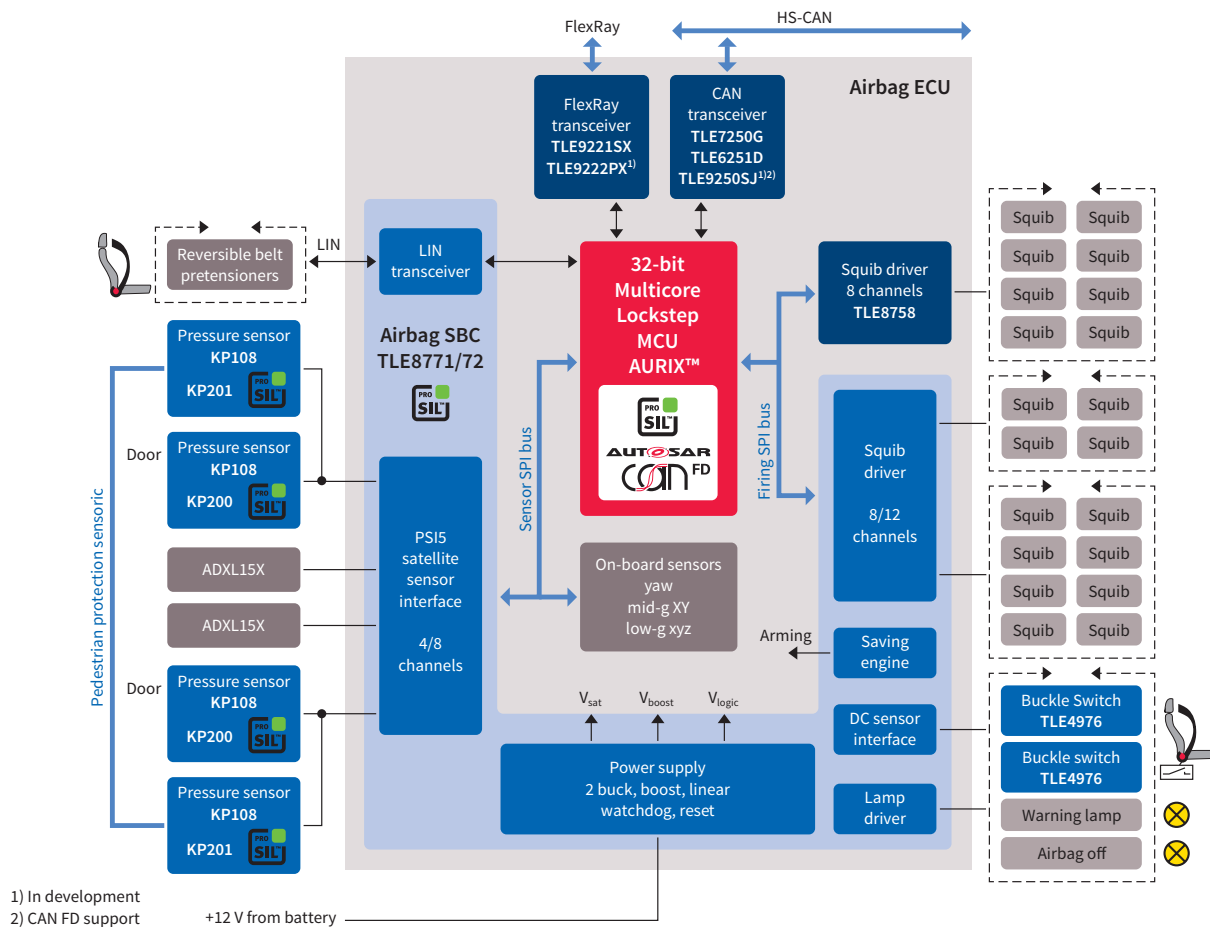

The new TriCore™ family AURIX™ with state-of-the-art safety features enables systems to achieve the highest safety level up to ASIL-D.

The scalability allows the selection of a single-core solution for basic airbag systems and multicore solutions for airbag systems with an integrated sensor cluster. The best cost-performance fit is offered by the wide range of Flash, performance and peripheral options available within the AURIX™ family.

### Application features

- > Scalable MCU family from single to multicore
- > Flash 512 KB–8 MB
- > Embedded EEPROM
- > Performance from 133 MHz–3x 300 MHz
- > Dedicated peripheral set: CAN, LIN, SPI, FlexRay, Ethernet
- > Hardware-focused safety concept for reduced SW overhead
- > Safety software: Infineon SafeTcore library
- > ISO 26262 conformance to support safety requirements up to ASIL-D
- > Availability of AUTOSAR 4.x

### System benefits

- > Scalability over Flash, RAM and peripherals offering the best cost-performance ratio
- > Proven safety concept to support ISO 26262
- > Innovative supply concept leads to best-in-class power consumption

### Suggested products

- > TC23x
- > TC22x
- > TC21x



# Braking

## Application example

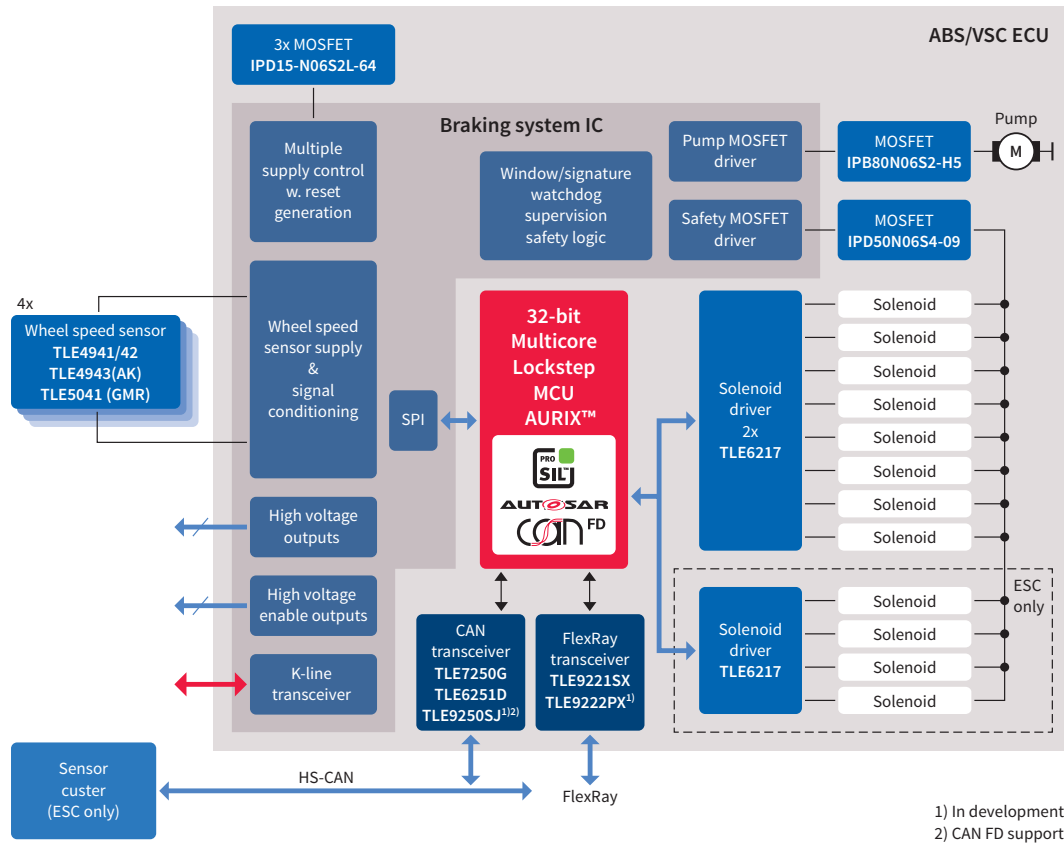

The new TriCore™ family AURIX™ with state-of-the-art safety features enables systems to achieve the highest safety level ASIL-D, which is already required in contemporary braking systems. The latest diverse lockstep technology with clock delay (diverse lockstep core) reduces the software overhead significantly and enables fast time-to-market. The scalability supports an optimized cost-performance fit for basic ABS systems up to highly-integrated ESC systems.

### Application features

- › Scalable MCU family with diverse lockstep
- › Flash 512 KB–8 MB
- › Performance from 133 MHz–3x 300 MHz
- › Hardware-focused safety concept for reduced SW overhead
- › SENT interface for low CPU load
- › Safety software: Infineon SafeTcore library
- › ISO 26262 conformance to support safety requirements up to ASIL-D
- › Availability of AUTOSAR 4.x

### System benefits

- › Scalability over Flash, RAM, performance and peripherals leads to an optimized cost-performance fit
- › Proven safety concept to support ISO 26262 validated by 3<sup>rd</sup> party
- › Innovative supply concept leads to best-in-class power consumption and saves external component costs

### Suggested products

- TC29x
- TC27x
- TC26x
- TC23x
- TC22x



# Multi-purpose camera configuration

## Application example

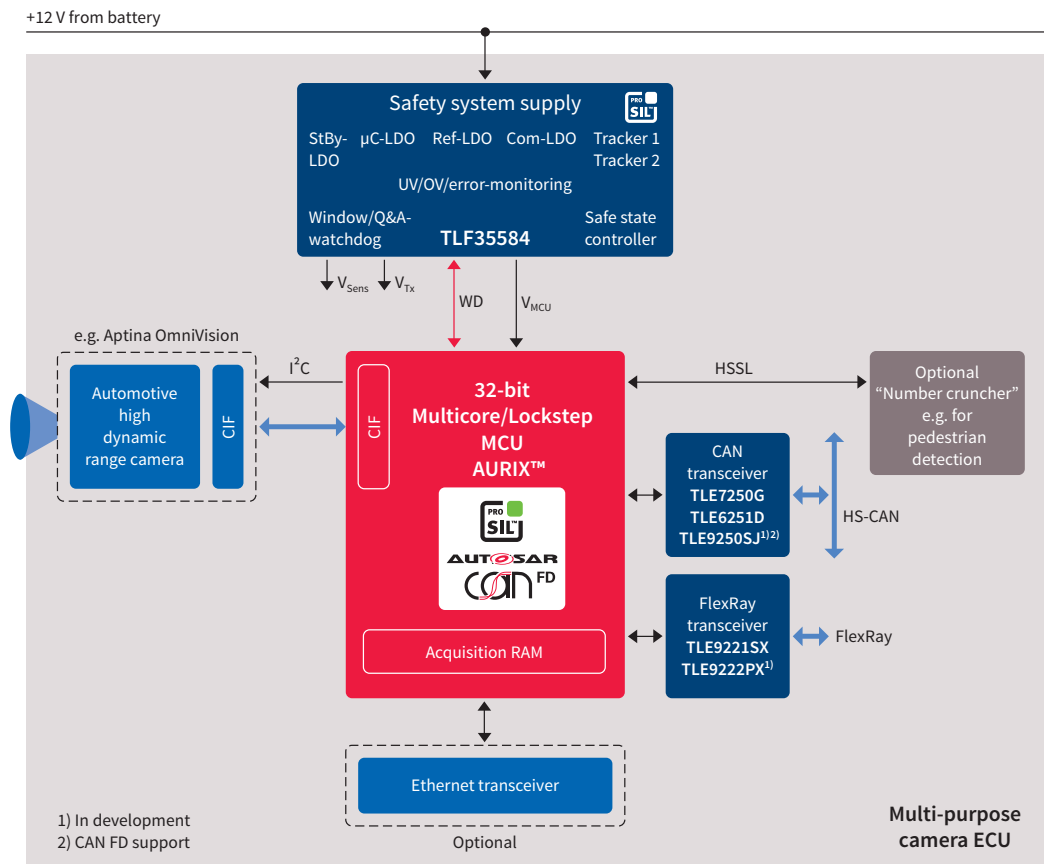

The new TriCore™ family AURIX™ will enhance classic safety features with dedicated features to cater for multi-purpose camera systems.

The combination of new features, such as a picture pre-processing unit, camera interface, DSP functionality and increased SRAM, in conjunction with outstanding safety features enables a high level of scalability in order to achieve the best cost-performance ratio.

### Application features

- › TriCore™ DSP functionality
- › Best-in-class performance: triple TriCore™ with up to 300 MHz per core
- › Supporting floating point and fix point with all cores
- › Up to 2.7 MB of internal RAM for picture information storage
- › Picture pre-processing unit
- › Camera interface up to 100 MHz
- › Innovative single supply 5 V or 3.3 V
- › External memory interface
- › ISO 26262 conformance to support safety requirements up to ASIL-D
- › Availability of AUTOSAR 4.x

### System benefits

- › High scalability option allows a dedicated performance feature fit for multiple camera applications from single automatic high beam systems up to multi-function systems (lane departure warning, forward collision warning, traffic sign recognition, pedestrian recognition etc.)
- › High integration leads to reduced complexity
- › Support for ISO 26262 decisions such as emergency braking
- › Innovative supply concept leads to best-in-class power consumption

### Suggested products

- › TC29xTA



# Short-range radar (24 GHz) system

## Application example

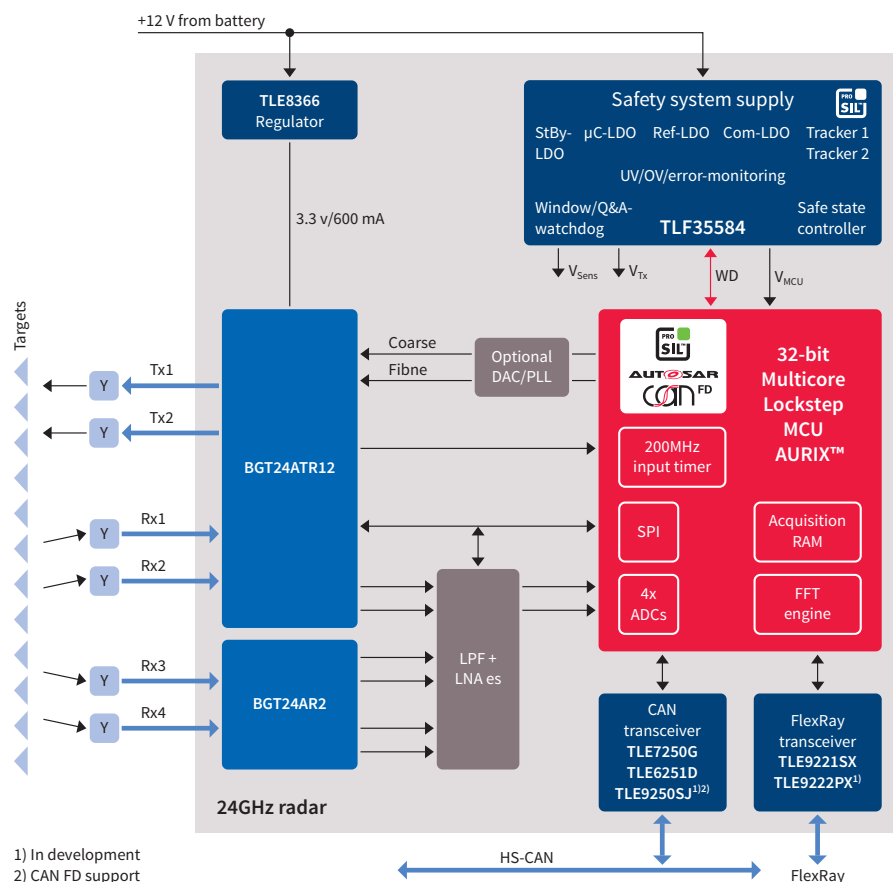

The new TriCore™ family AURIX™ will enhance classic safety features with dedicated features to serve the needs of 24 GHz radar systems.

The combination of new features and increased SRAM, in conjunction with outstanding safety features, enables a high level of integration and reduction of complexity.

### Application features

- › Up to 752 KB RAM for radar image storage
- › Radar signal processing with windowing functionality
- › Flexibility in radar signal acquisition with 4x internal ADCs
- › Possibility to connect external ADCs (interface to connect up to 16-bit ADCs)
- › High-precision input timers
- › High-precision output timers for DAC
- › Innovative single supply 5 V or 3.3 V
- › ISO 26262 compliance to support safety requirements up to ASIL-D
- › Availability of AUTOSAR 4.x

### System benefits

- › High integration leads to significant cost savings
- › High integration leads to reduced complexity
- › ISO 26262 compliance supports safe input for functions such as emergency braking
- › Innovative supply concept

### Suggested products

- › TC23xLA
- › TC26xDA
- › TC29xTA

# Long-range radar (76/77 GHz) system

## Application example

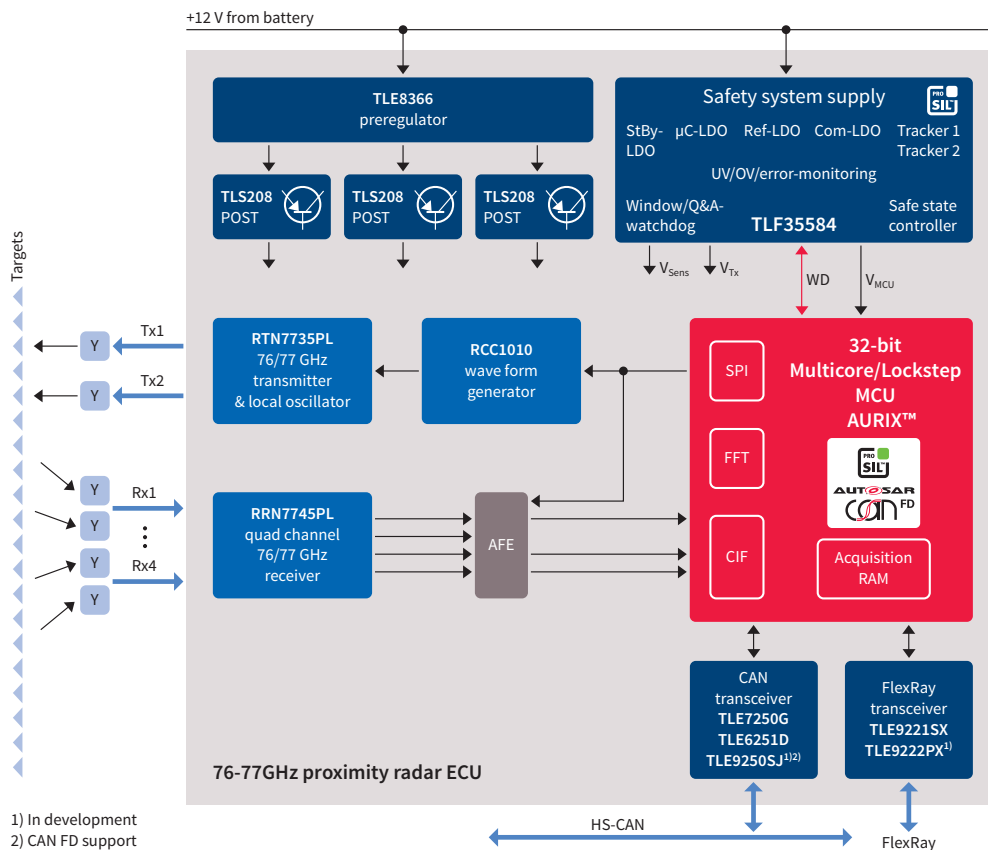

The new TriCore™ family AURIX™ will enhance classic safety features with dedicated features to serve the needs of 77 GHz radar systems.

The combination of new features and increased SRAM, in conjunction with outstanding safety features, enables a high level of integration and reduction of complexity.

### Application features

- > TriCore™ DSP functionality
- > Best-in-class performance: triple TriCore™ with up to 300 MHz per core
- > Up to 2.7 MB RAM for radar image storage
- > Radar signal processing with windowing functionality
- > Flexibility in radar signal acquisition with 4x internal ADCs
- > Possibility to connect external ADCs (interface to connect up to 16-bit ADCs)
- > High-precision input timers
- > High-precision output timers for DAC
- > Innovative single supply 5 V or 3.3 V
- > External memory interface
- > ISO 26262 compliance to support safety requirements up to ASIL-D
- > Availability of AUTOSAR 4.x

### System benefits

- > High integration leads to significant cost savings
- > High integration leads to reduced complexity
- > ISO 26262 compliance supports safe input for functions such as emergency braking
- > Innovative supply concept leads to best-in-class power consumption

### Suggested products

- > TC26xDA
- > TC29xTA





# AURIX™ for connectivity applications

Connectivity electronics systems embrace a broad variety of applications inside the car, covering comfort, safety and security as well as high-performance computing and in-vehicle networking. **This leads to the key strengths of the AURIX™ family:**

- › **AUTOSAR** – With AUTOSAR 4, multicore architectures can be easily designed into vehicles. Infineon is one of the first implementers of a multicore architecture with AURIX™ ready for AUTOSAR 4.x. Furthermore, Infineon also provides the MCAL drivers developed according to the CMM 3 level.
- › **Power consumption** – Innovative supply concept automatically adapts the power consumption to the actual performance requirements. Furthermore, the new trend of pretended networking and ECU degradation is actively supported.
- › **Enhanced communication** – As cars incorporate an increasing amount of electronics, the body electronics module's responsibilities increase to handle the additional components and message traffic. Because of the gateway functionality of the BCM, the AURIX™ has enhanced communication capabilities to support communication between CAN FD, LIN, FlexRay™ and Ethernet buses.
- › **Safety** – The trend is toward the integration of safety targets in the requirements of advanced body systems such as lighting, BCM etc. To achieve the required ASIL level according to ISO 26262, AURIX™ has the capability to cover targets up to the highest safety integrity level ASIL-D.
- › **Security** – In the future, the need for a high level of security will also expand into body applications. Cars are expected to hold even more information as they become smart cards on wheels for simplifying financial transactions at gas pumps, charging stations, parking lots, toll booths, drive-through shops and more. The vehicle will act as a smart card and pay your fee/fare – sometimes automatically. Hardware-based security is more robust than software-only security. AURIX™ provides a dedicated module, HSM (Hardware Secure Module), to cover the highest level of security.

# Telematics control unit for over-the-air updates

## Application example

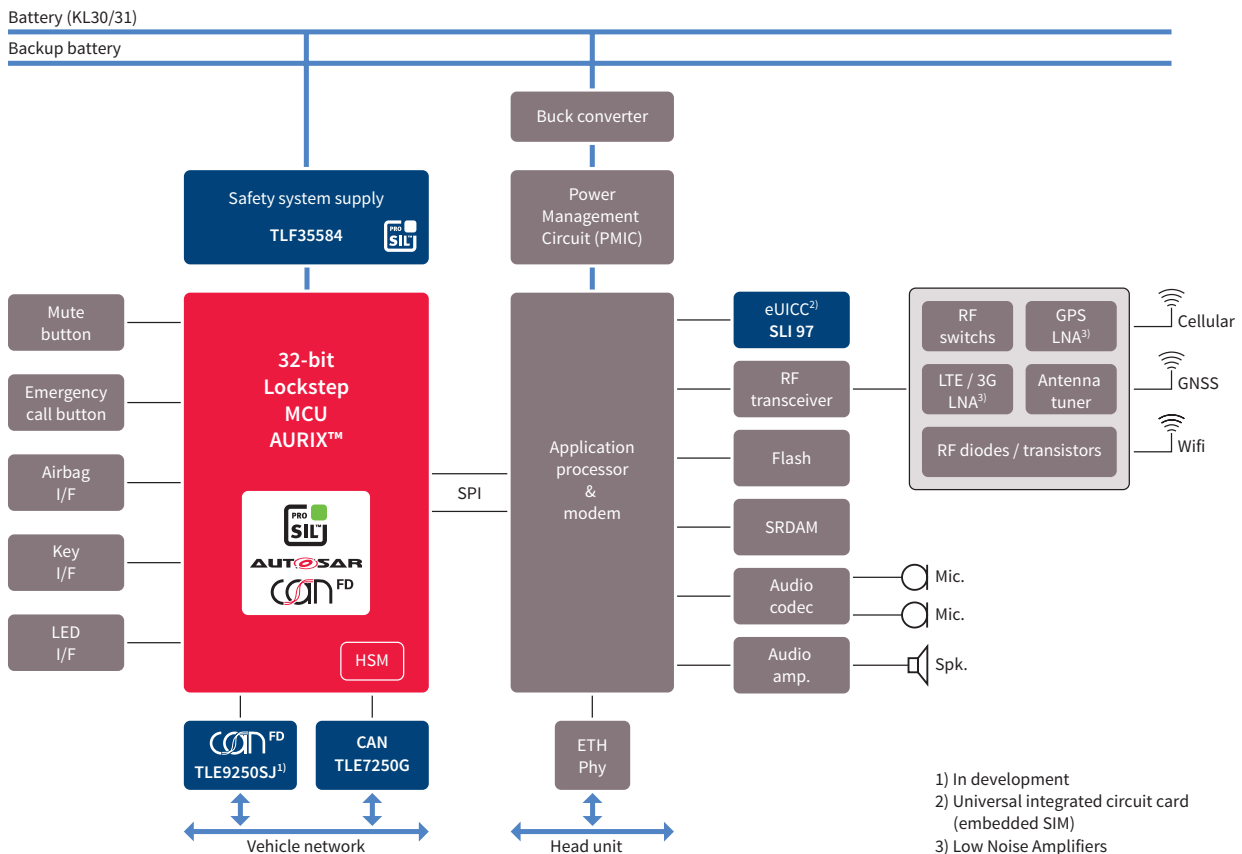

The telematics control unit connects the car to the outside world and thereby enables numerous new applications and functionalities. Software in different ECUs can be updated remotely, to either add new features or remove any software bugs that might be found during operation. This reduces the number of recalls and related costs and increases customer satisfaction. The possibility of adding new features opens up the door for new business models and revenue streams.

### Application features

- > eCall
- > Remote diagnostics
- > Payment systems
- > Software update
- > Feature upgrades
- > Internet services
- > etc.

### System benefits

- > System supplies, bock converter, active antenna supplies etc.
- > Secure elements (eUICC, OPTIGA™ TPM 2.0, SLI 97 V2X etc.)
- > RF switches, RF diodes/transistors, low-noise amplifiers (GPS, LTE etc.)
- > Silicon microphone

### Application features

- > TC23x – TriCore™ 32-bit microcontroller
  - Superior Hardware Security Solution (HSM) + functional safety up to ASIL-D (e.g. eCall, V2x communication, software update of safety-critical ECUs)
  - Automotive & consumer interfaces (incl. CAN/-FD, FlexRay, Ethernet etc.)
  - Highly scalable product portfolio (starting with 2 MB & QFP-100 at the lowest end)

# High-feature body control module with integrated gateway functionality

Application example

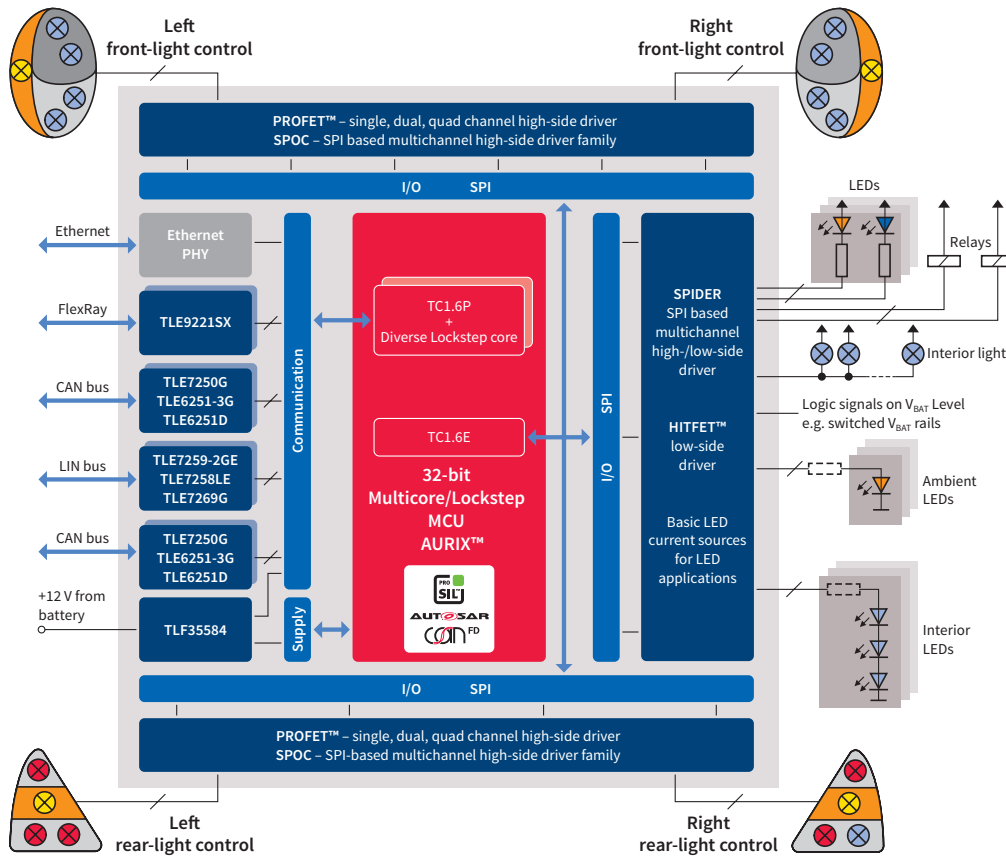

Body Control Module (BCM) application comprising internal and external lighting systems, as well as control of relays and voltage rails and further comfort functions such as door and wiper control. The central gateway manages all internal interfaces (i.e. motor management, in-car entertainment, dashboard or convenience control) and communication with external interfaces for after-sales software updates. The AURIX™ multicore concept enables the integration of two applications in one device, e.g. BCM and gateway.

## Application features

- > Scalable MCU family from single to multicore
- > Encapsulation feature allows software development without interference for multiple applications
- > Embedded EEPROM
- > Advanced communication peripherals: CAN, LIN, SPI, FlexRay, Ethernet
- > ISO 26262 conformance to support safety requirements up to ASIL-D
- > Availability of AUTOSAR 4.x

## System benefits

- > Enables pretended networking and ECU degradation
- > High integration leads to significant cost savings
- > High integration leads to reduced complexity
- > ISO 26262 compliance supports ASIL requirements
- > Innovative supply concept leads to best-in-class power consumption

## Suggested products

- > TC29x
- > TC23x
- > TC22x
- > TC21x





## TriCore™ for transportation applications optimized with scalable AURIX™ family

AURIX™ is Infineon's brand new family of microcontrollers serving exactly the needs of the 24 V–60 V industry in terms of performance, memory, scalability, safety and security.

Its innovative multicore architecture supports the latest trends in connectivity, such as Ethernet and CAN FD as well as safety (IEC 61508/ISO 25119/ISO 26262) and security.

While supporting high performance, the innovative supply concept with integrated DC/DC converter leads to best-in class power consumption.

The scalable AURIX™ family leads to the most optimized cost-performance application fit.

# Commercial and Agricultural Vehicles (CAV)

A 24 V complete system solution for hydraulic/pneumatic management systems: power supply, sensors, microcontroller and high-side switches can be used without external protection in a 24 V system. Valves and pumps can be driven via linear activation or demand-controlled via PWM signals.

## Hydraulic management system

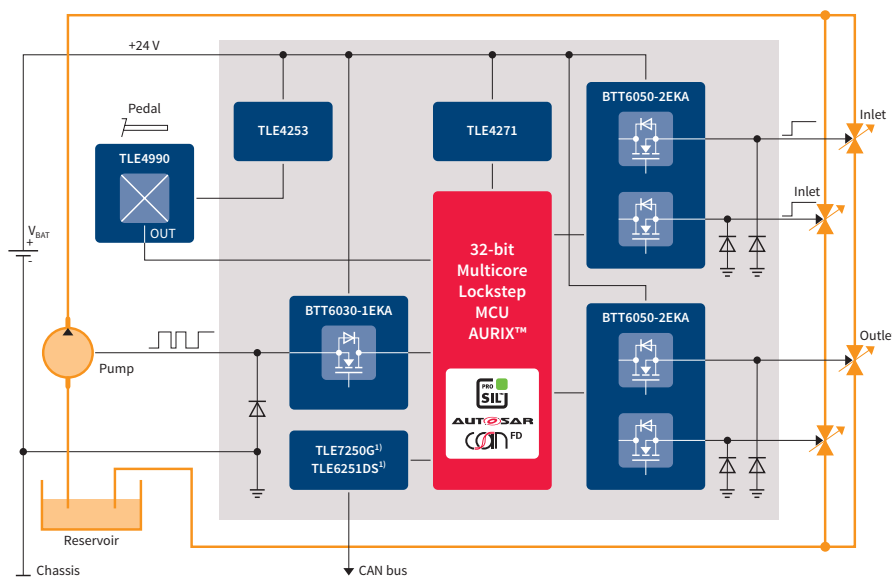

1) If ECU permanently supplied, you may need to add external protection against load dump 400 ms above 40 V.

### System benefits

- > Valves and pumps can be driven via linear activation or demand-controlled via PWM signals
- > Quad and dual channels are optimized to reduce costs and space for these applications
- > Pin-to-pin and software compatibility
- > ISO 26262, ASIL D/SIL 3 compliant
- > AECQ-100

### Suggested products

- > TC23x
- > TC22x
- > TC21x

## Pneumatic management system

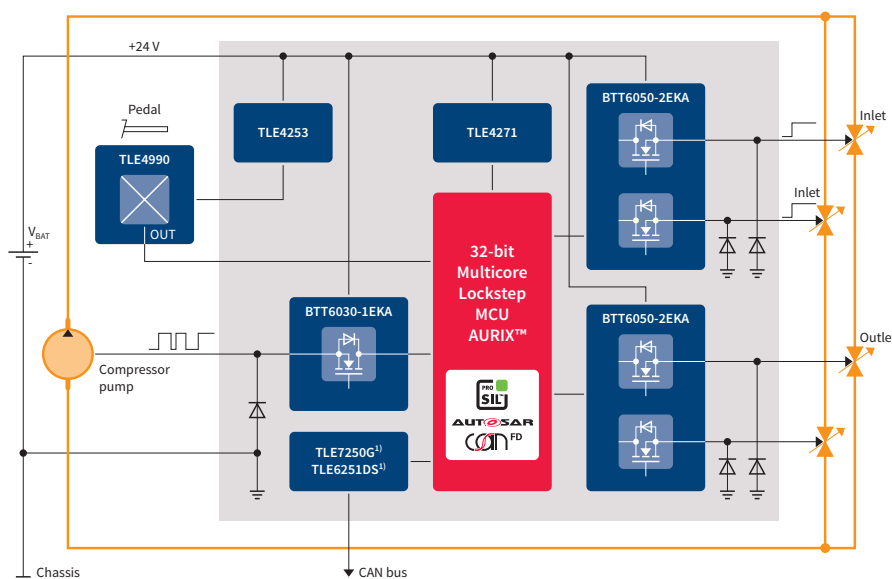

1) If ECU permanently supplied, you may need to add external protection against load dump 400 ms above 40 V.

### System benefits

- > Valves and pumps can be driven via linear activation or demand-controlled via PWM signals
- > Quad and dual channels are optimized to reduce costs and space for these applications
- > Pin-to-pin and software compatibility
- > ISO 26262, ASIL D/SIL 3 compliant
- > AECQ-100

### Suggested products

- > TC23x
- > TC22x
- > TC21x





## AURIX™ for industrial applications

### High-performance, multicore and safety-demanding applications

The AURIX™ 32-bit microcontroller family is based on the Infineon TriCore™ high-performance core concept and provides a very high scalability family from single core to multi core.

The AURIX™ family enabling highest integrated safe memory sizes (SRAM up to 2.7 MB and flash memory up to 8 MB) and all memory is protected by hardware Error Correction Code (ECC). The devices reach more than 600 DMIPS at clock rates of up to 300 MHz and combine MCU & DSP instructions with an integrated FPU.

The integrated peripheral set is primarily targeted toward motor control and power conversion providing up to 11 ADCs, DS ADCs and a full set of diverse high-performance timers – namely the General Timer Module (GTM), CapCom 6, GPT12. This is one of the very few in the industry that is able to drive the upcoming three-level inverter topologies.

Furthermore the AURIX™ family supports the latest connectivity like Ethernet, CAN FD, Flexray and multiple other high speed interfaces.

### Providing security and functional safety

In a global economy, IP protection and secure communication plays an increasingly important role. This demand is accounted for by the integration of special security modules providing the required means of safe key storage, along with secure boot and encryption on the hardware level. As one of the leaders in functional safety, Infineon has designed the TriCore™ MCUs to meet the growing demand for functional safety in the industrial market as specified in IEC 61508. Via our cooperation partner Hitex, Infineon offers a complete package comprising a microcontroller, safety supply with integrated watchdog TLF35584, software and documentation, achieving safety integrity levels up to SIL3.

The next generation of TriCore™-based microcontrollers – AURIX™ – will provide another significant performance milestone by integrating up to three cores in one device. The multicore concept is targeted at running concurrent applications in parallel. Some of the integrated cores integrate lockstep functionality and the peripherals can be allocated to individual cores. This allows running a combination of safety-critical tasks, such as controlling an inverter, with non-critical tasks, such as network communication, on a single MCU.

# Mobile controller

## Application example

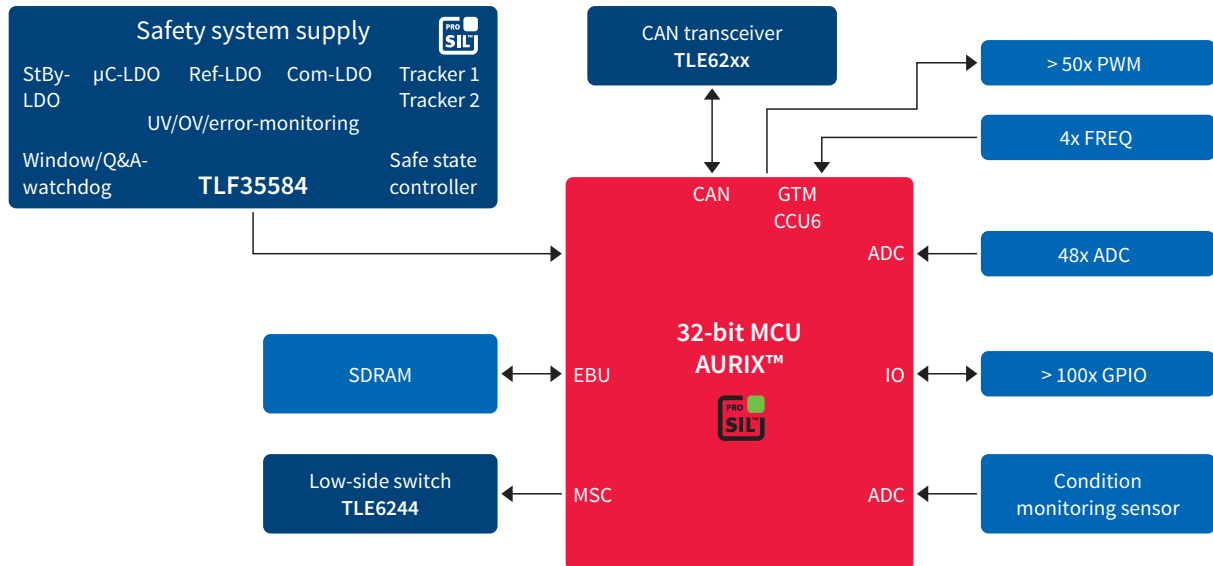

### Application features

- > Closed-loop control of solenoid currents
- > Multitasking to drive hydraulic and electric actuators
- > IEC 61131-3 support
- > Tasking/Green Hills/GNU(Hightec)/windriver toolchain
- > Ready for harsh environments
- > IEC 61508 support - Integrity Level (SIL) 1 to 3

### Suggested products

- > TC26xD – TriCore™ 32-bit microcontroller
- > TC27xT – TriCore™ 32-bit microcontroller

### System benefits

- > Scalable family with compatibility: SW, pin-out
- > High-speed 200 MHz asymmetric single/dual/triple core
- > Up to 50 Pulse-Width-Modulated (PWM) outputs
- > Four 12-bit Analog to Digital Converters (SAR-ADC)
- > 12-bit, up to 60 channels
- > DS-ADC converter
- > Temperature range up to  $T_a = 150\text{ }^\circ\text{C}$ ,  $T_j = 175\text{ }^\circ\text{C}$
- > SAE J1939 supported for up to 6 CAN nodes incl. CAN FD
- > 64 KB EEPROM
- > Innovative single power supply concept

# Inverter

## Application example

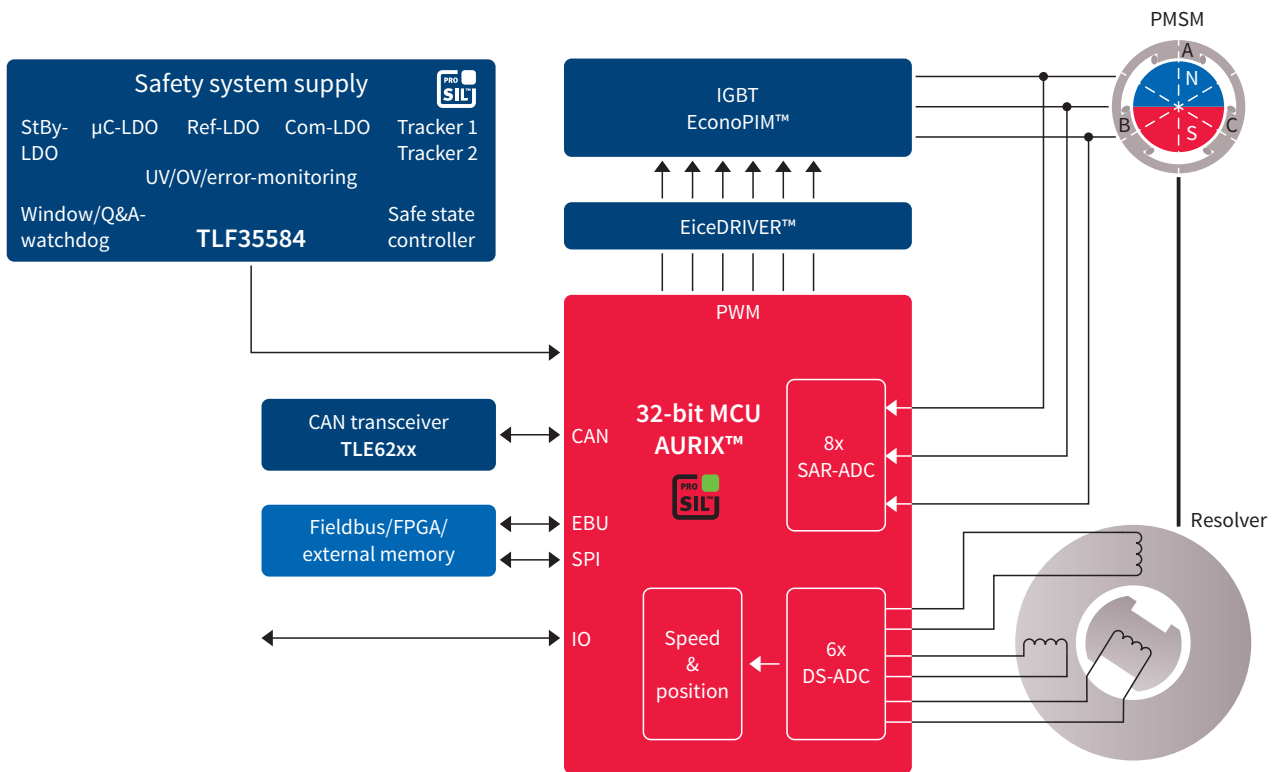

### Application features

- > Multi-axis controller for two 3-phase complementary PWMs
- > Multiple modulation strategies (SVPWM, DPWM, soft-PWM, direct torque control) to support requirements for reduced noise emissions and increased efficiency
- > Ready for four Q-inverters, matrix-inverters
- > Field-oriented control with less than 10% CPU load
- > Multiprocessor support for reliability and safety
- > Support for 3-level inverter topologies
- > High computing performance up to 3 x 300 MHz
- > Up to 2.7 MB internal RAM

### Suggested products

- > TC27xT – TriCore™ 32-bit microcontroller
- > TC29xT – TriCore™ 32-bit microcontroller

### System benefits

- > Diverse timer architecture: generic timer module (GTM), CCU6, GPT12
- > 8 SAR-ADCs 12-bit resolution, 1 MSPS
- > DS-ADC
- > Resolver I/F
- > Encoder I/F with digital noise filter
- > Very fast control loop
- > IEC 61508 support – Integrity Level (SIL) 1 to 3
- > Innovative single power supply concept

# Wind turbine inverter

## Application example

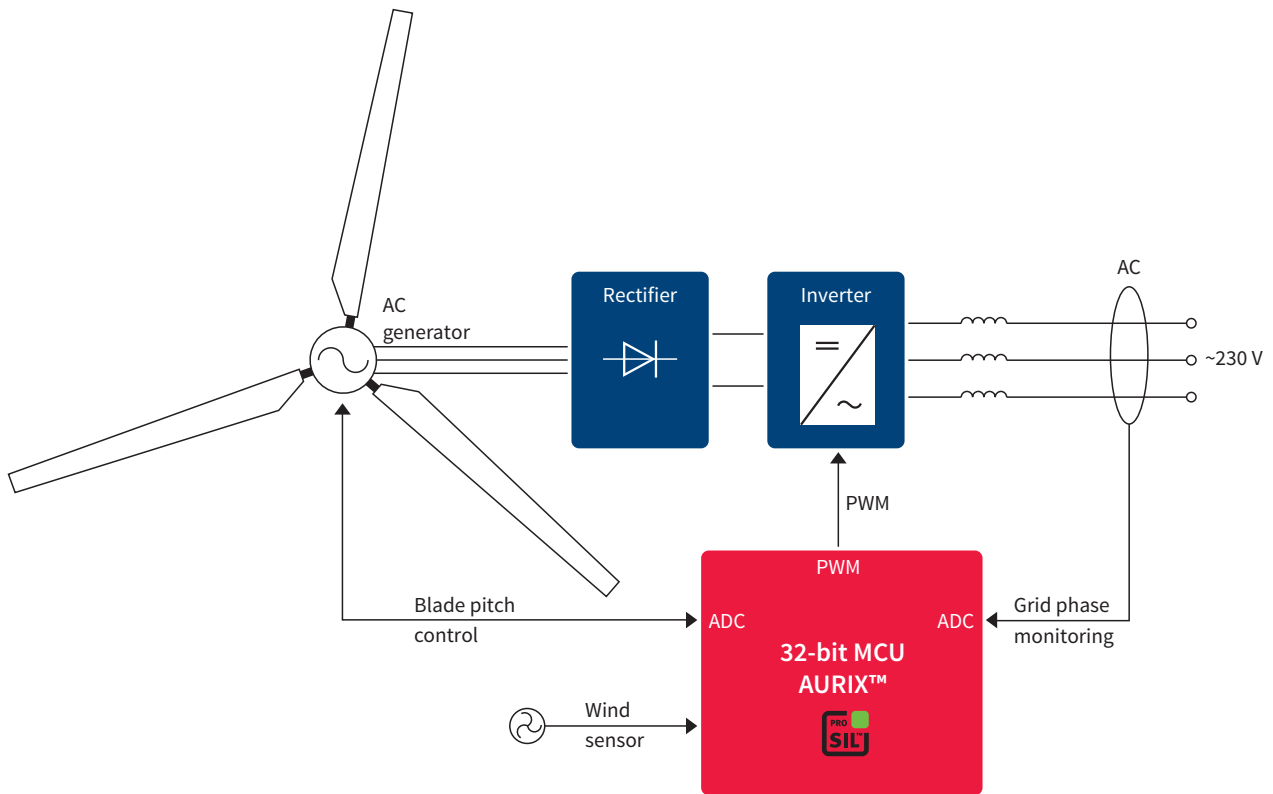

### Application features

- > Reliable blade pitch control
- > Increased wind turbine efficiency
- > Multiple modulation strategies (SVPWM, DPWM, soft-PWM, direct torque control) to support requirements for reduced noise emissions and increased efficiency
- > Multiprocessor support for reliability and safety
- > Support for 3-level inverter topologies

### Suggested products

- > TC26xD – TriCore™ 32-bit microcontroller
- > TC27xT – TriCore™ 32-bit microcontroller

### System benefits

- > Diverse timer architecture: generic timer module (GTM), CCU6, GPT12
- > 8 SAR-ADCs 12-bit resolution, 1 MSPS
- > DS-ADC
- > Resolver I/F
- > Encoder I/F with digital noise filter
- > IEC 61508 support - Integrity Level (SIL) 1 to 3
- > Innovative single power supply concept

# Solar panel

## Application example

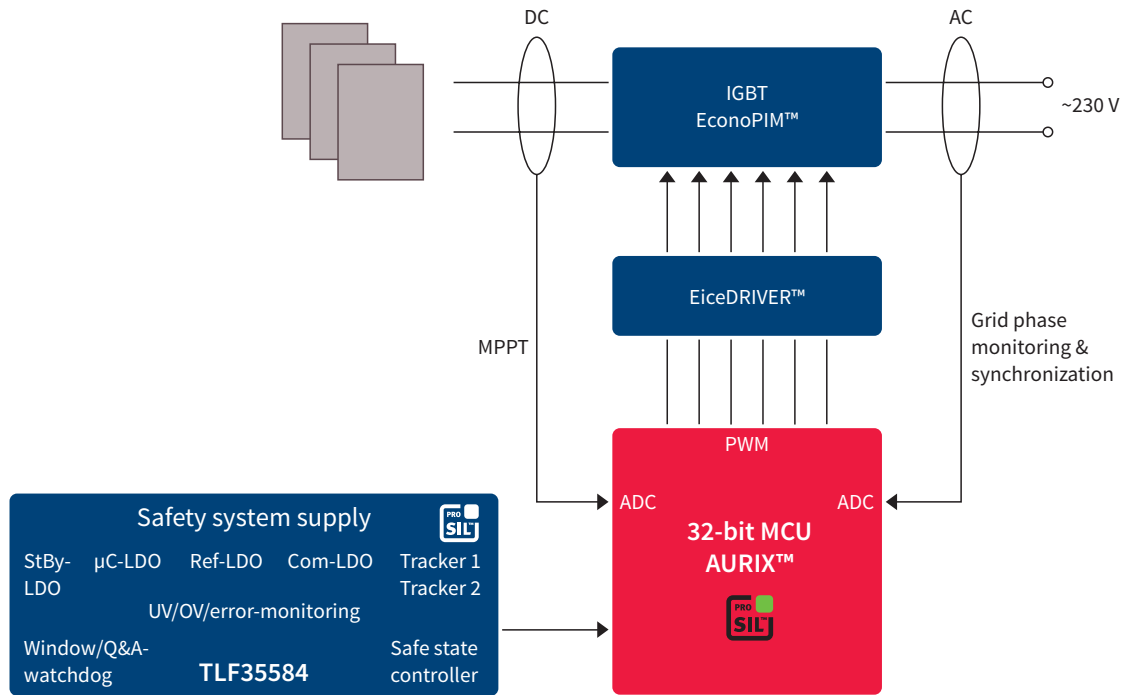

### Application features

- > Multi-phase PWM controller for single or multiple strings
- > Runs multiple modulation strategies (SVPWM, DPWM, soft-PWM, direct torque control) to support requirements for reduced noise emissions and increased efficiency
- > Maximum Power Point Tracking (MPPT) to extract maximum power from solar panels
- > Grid phase monitoring and synchronization to ensure power factor unity
- > Current control to avoid disharmonics and to determine the feed-in refund
- > Support for 3-level inverter topologies

### Suggested products

- > TC26xD – TriCore™ 32-bit microcontroller
- > TC27xT – TriCore™ 32-bit microcontroller

### System benefits

- > Diverse timer architecture: generic timer module (GTM), CCU6, GPT12
- > 8 SAR-ADCs 12-bit resolution, 1 MSPS
- > DS-ADC
- > Resolver I/F
- > Encoder I/F with digital noise filter
- > IEC 61508 support - Integrity Level (SIL) 1 to 3
- > Innovative single power supply concept
- > DSP library available

### Maximum Power Point Tracking (MPPT)

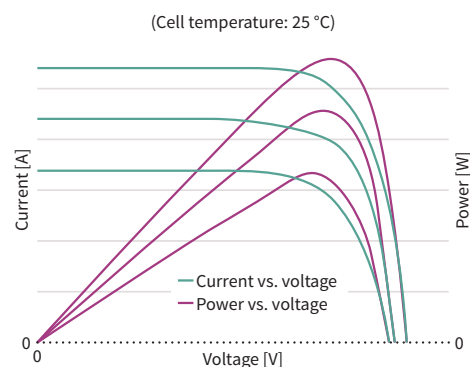

# TriCore™ tool partners

## Embedded software solutions AUTOSAR suites



## Simulation/virtual prototyping



## Integrated compiler environments



## Auto code generation tools



## Timing/scheduling analysis



## Operating systems



## Debugger and test tools



## Data measurement/calibration/rapid prototyping



## Programmer/flash tools



## Software verification



## Training/services



## Free tooling

Free TriCore™ Entry Toolchain, MemTool, ACT

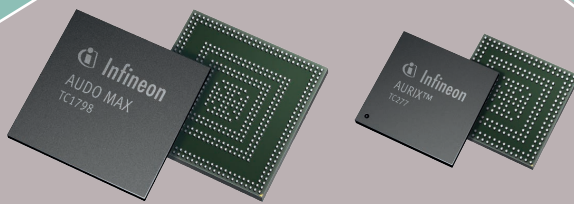

# Feature overview TriCore™ family

TriCore™ microcontroller

Product type	Max clock frequency [MHz]	Program memory [KByte]	SRAM (incl. cache) [KByte]	Co-processor <sup>1)</sup>	Cores/lockstep	Timed I/O GPIO	Number of ADC channels	External bus interface	CAN/CAN-FD nodes	Communication interfaces <sup>2)</sup>	Temperature ranges <sup>3)</sup>	Packages	Additional features/remarks <sup>4)</sup>
AURIX™ – family													
TC299TX	300	8000	2728	FPU	3/1	263	84/10 DS	Yes	6	4x ASCLIN, 6x QSPI, 3x MSC, 2x I <sup>2</sup> C, 15x SENT, HSSL, 5x PSi5, 2x FlexRay, Ethernet	K	LFBGA-516	EVR, STBU, HSM
TC299TP	300	8000	728	FPU	3/1	263	84/10 DS	Yes	6	4x ASCLIN, 6x QSPI, 3x MSC, 2x I <sup>2</sup> C, 15x SENT, HSSL, 5x PSi5, 2x FlexRay, Ethernet, CAN FD	K	LFBGA-516	EVR, STBU, HSM
TC298TP	300	8000	728	FPU	3/1	232	60/10 DS	Yes	6	4x ASCLIN, 6x QSPI, 3x MSC, 2x I <sup>2</sup> C, 15x SENT, HSSL, 5x PSi5, 2x FlexRay, Ethernet	K	LFBGA-416	EVR, STBU, HSM
TC297TA	300	8000	2728	FPU, FFT, CIF	3/1	169	60/10 DS	No	6	4x ASCLIN, 6x QSPI, 3x MSC, 2x I <sup>2</sup> C, 15x SENT, HSSL, 5x PSi5, 2x FlexRay, Ethernet	K	LFBGA-292	EVR, STBU, HSM
TC297TX	300	8000	2728	FPU	3/1	263	60/10 DS	No	6	4x ASCLIN, 6x QSPI, 3x MSC, 2x I <sup>2</sup> C, 15x SENT, HSSL, 5x PSi5, 2x FlexRay, Ethernet	K	LFBGA-292	EVR, STBU, HSM
TC297TP	300	8000	728	FPU	3/1	169	60/10 DS	No	6	4x ASCLIN, 6x QSPI, 3x MSC, 2x I <sup>2</sup> C, 15x SENT, HSSL, 5x PSi5, 2x FlexRay, Ethernet, CAN FD	K	LFBGA-292	EVR, STBU, HSM
TC277TP	200	4000	472	FPU	3/2	169	60/6 DS	No	4	4x ASCLIN, 4x QSPI, 2x MSC, HSSL, I <sup>2</sup> C, 10x SENT, 3x PSi5, FlexRay, Ethernet, CAN FD	K	LFBGA-292	EVR, WUT, HSM
TC275TP	200	4000	472	FPU	3/2	112	48/6 DS	No	4	4x ASCLIN, 4x QSPI, 2x MSC, HSSL, I <sup>2</sup> C, 10x SENT, 3x PSi5, FlexRay, Ethernet, CAN FD	K	LQFP-176	EVR, WUT, HSM
TC267D	200	2500	240	FPU	02/1	169	50/3 DS	No	5	4x ASCLIN, 4x QSPI, 2x MSC, I <sup>2</sup> C, 10x SENT, 3x PSi5, HSSL, FlexRay, Ethernet, CAN FD	K	LFBGA-292	EVR, STBU
TC265D	200	2500	240	FPU	2/1	112	50/3 DS	No	5	4x ASCLIN, 4x QSPI, 2x MSC, I <sup>2</sup> C, 10x SENT, HSSL, 3x PSi5, FlexRay, Ethernet, CAN FD	K	LQFP-176	EVR, STBU
TC264DA	200	2500	752	FPU, FFT, CIF	2/1	88	40/3 DS	No	5	4x ASCLIN, 4x QSPI, 2x MSC, I <sup>2</sup> C, 10x SENT, HSSL, 3x PSi5, FlexRay, Ethernet, CAN FD	K	LQFP-144	EVR, STBU
TC264D	200	2500	240	FPU	2/1	88	40/3 DS	No	5	4x ASCLIN, 4x QSPI, 2x MSC, I <sup>2</sup> C, 10x SENT, HSSL, 3x PSi5, FlexRay, Ethernet, CAN FD	K	LQFP-144	EVR, STBU
TC237LP	200	2000	192	FPU	1/1	120	24	No	6	2x ASCLIN, 4x QSPI, 4x SENT, FlexRay, CAN FD	K	LFBGA-292	EVR, WUT, HSM
TC234LA	200	2000	704	FPU, FFT	1/1	120	24	No	6	2x ASCLIN, 4x QSPI, 4x SENT, FlexRay, Ethernet	K	TQFP-144	EVR, WUT, HSM
TC234LX	200	2000	704	FPU	1/1	120	24	No	6	2x ASCLIN, 4x QSPI, 4x SENT, FlexRay, Ethernet	K	TQFP-144	EVR, WUT, HSM
TC234LP	200	2000	192	FPU	1/1	120	24	No	6	2x ASCLIN, 4x QSPI, 4x SENT, FlexRay, CAN FD	K	TQFP-144	EVR, WUT, HSM
TC233LP	200	2000	192	FPU	1/1	78	24	No	6	2x ASCLIN, 4x QSPI, 4x SENT, FlexRay, CAN FD	K	TQFP-100	EVR, WUT, HSM
TC224L	133	1000	96	FPU	1/1	120	24	No	3	2x ASCLIN, 4x QSPI, 4x SENT	K	TQFP-144	EVR, WUT
TC223L	133	1000	96	FPU	1/1	78	24	No	3	2x ASCLIN, 4x QSPI, 4x SENT	K	TQFP-100	EVR, WUT
TC222L	133	1000	96	FPU	1/1	59	14	No	3	2x ASCLIN, 4x QSPI, 4x SENT	K	TQFP-80	EVR, WUT
TC214L	133	500	96	FPU	1/1	120	24	No	3	2x ASCLIN, 4x QSPI, 4x SENT	K	TQFP-144	EVR, WUT
TC213L	133	500	96	FPU	1/1	78	24	No	3	2x ASCLIN, 4x QSPI, 4x SENT	K	TQFP-100	EVR, WUT
TC212L	133	500	96	FPU	1/1	59	14	No	3	2x ASCLIN, 4x QSPI, 4x SENT	K	TQFP-80	EVR, WUT

1) CIF = Camera and external ADC interface, FFT = Fast Fourier Transform Accelerator, FPU = Floating Point Unit, PCP = Peripheral Control Processor

2) ASC = Asynchronous Serial Channel, ASCLIN = Asyn/Synchronous Local Interconnect Network, HSSL = High Speed Serial Link, I<sup>2</sup>C = Inter-Integrated Circuit, LIN = Local Interconnect Network, MLI = Micro Link Interface, MSC = Micro Second Channel, PSi5 = Peripheral Sensor Interface 5, QSPI = Queued Serial Peripheral Interface, SENT = Single Edge Nibble Transmission, SSC = Synchronous Serial Channel

3) Ambient temperature range: A = -40 ... 140 °C, B = 0 ... 70 °C, F = -40 ... 85 °C, H = -40 ... 110 °C, K = -40 ... 125 °C, L = -40 ... 150 °C, X = -40 ... 105 °C

4) EVR = Embedded Voltage Regulator, HSM = Hardware Security Module, STBU = Stand-by Control Unit, WUT = Wake-Up Timer

# Feature overview TriCore™ family

TriCore™ microcontroller

Product type	Max clock frequency [MHz]	Program memory [kByte]	SRAM (incl. cache) [kByte]	Co-processor	Digital I/O lines	Number of ADC channels	Timed I/O channels (PWM, capture)	External bus interface	CAN nodes	Communication interfaces	Temperature ranges	Package	ASC	SSC	Additional features / remarks
<b>AUDO – next generation family</b>															
TC1762-1128F	66–80	1000	52	FPU	81	32	48	No	2	2x ASC, 1x SSC, 1x MSC, 1x MLI	K	LQFP-176	2x	1x	–
TC1766-192F80HL	80	1500	108	FPU, PCP	81	32	48	No	2	2x ASC, 2x SSC, 1x MSC, 2x MLI	K	LQFP-176	2x	2x	–
TC1796-256F150E	150	2000	256	FPU, PCP	123	44	126	Yes	4	2x ASC, 2x SSC, 2x MSC, 2x MLI	K	BGA-416	2x	2x	–
<b>AUDO – future family</b>															
TC1736-128F80HL	80	1000	48	FPU	70	24	53	No	2	2x ASC, 2x SSC, 1x MSC, 1x MLI	K	LQFP-144	2x	2x	–
TC1767-256F	80–133	2000	128	FPU, PCP	88	36	80	No	2	2x ASC, 2x SSC, 1x MSC, 1x MLI	K	LQFP-176	2x	2x	–
TC1797-512F180E	180	4000	224	FPU, PCP	221	48	118	Yes	4	2x ASC, 2x SSC, 2x MSC, 2x MLI	K	BGA-416	2x	2x	–
<b>AUDO MAX – family</b>															
TC1724N-192F80HR	80	1500	152	FPU, PCP	95	28	77	No	3	2x ASC, 4x SSC, 1x MSC, 1x MLI	K	LQFP-144	2x	4x	EVR
TC1728N-192F133HR	133	1500	152	FPU, PCP	127	36	94	No	3	2x ASC, 4x SSC, 1x MSC, 1x MLI	K	LQFP-176	2x	4x	EVR
TC1782F-320F180HR	180	2500	176	FPU/PCP	86	36	80	No	3	2x ASC, 3x SSC, 1x MSC, 1x MLI, 2x FlexRay	K	LQFP-176	2x	3x	–
TC1784F-320F180EL	180	2500	176	FPU/PCP	126	36	122	Yes	3	2x ASC, 3x SSC, 1x MSC, 1x MLI, 2x FlexRay	K	LFPGA-292	2x	3x	–
TC1791F-512F240EP	240	4000	288	FPU/PCP	144	48	100	No	4	2x ASC, 4x SSC, 2x MSC, 2x MLI, 8x SENT, 2x FlexRay	K	LFPGA-292	2x	4x	–
TC1793F-512F270EF	270	4000	288	FPU/PCP	221	44	112	Yes	4	2x ASC, 4x SSC, 2x MSC, 2x MLI, 8x SENT, 2x FlexRay	K	LBGA-416	2x	4x	–
TC1798F-512F300EP	300	4000	288	FPU/PCP	252	72	138	Yes	4	2x ASC, 4x SSC, 2x MSC, 2x MLI, 8x SENT, 2x FlexRay	K	BGA-516	2x	4x	–

**ASC** = Asynchronous Serial Channel

**EVR** = Embedded Voltage Regulator

**FPU** = Floating Point Unit

**MSC** = Micro Second Channel

**MLI** = Micro Link Interface

**PCP** = Peripheral Control Processor

**SDIO** = SD Card Interface with Input/Output

**SENT** = Single Edge Nibble Transmission

**SSC** = Synchronous Serial Channel

**USIC** = ASC, SPI, I<sup>2</sup>C, I<sup>2</sup>S

**K** = -40/+125 °C

Published by  
Infineon Technologies AG  
85579 Neubiberg, Germany

© 2016 Infineon Technologies AG.  
All Rights Reserved.

#### Please note!

THIS DOCUMENT IS FOR INFORMATION PURPOSES ONLY AND ANY INFORMATION GIVEN HEREIN SHALL IN NO EVENT BE REGARDED AS A WARRANTY, GUARANTEE OR DESCRIPTION OF ANY FUNCTIONALITY, CONDITIONS AND/OR QUALITY OF OUR PRODUCTS OR ANY SUITABILITY FOR A PARTICULAR PURPOSE. WITH REGARD TO THE TECHNICAL SPECIFICATIONS OF OUR PRODUCTS, WE KINDLY ASK YOU TO REFER TO THE RELEVANT PRODUCT DATASHEETS PROVIDED BY US. OUR CUSTOMERS AND THEIR TECHNICAL DEPARTMENTS ARE REQUIRED TO EVALUATE THE SUITABILITY OF OUR PRODUCTS FOR THE INTENDED APPLICATION.

WE RESERVE THE RIGHT TO CHANGE THIS DOCUMENT AND/OR THE INFORMATION GIVEN HEREIN AT ANY TIME.

#### Additional information

For further information on technologies, our products, the application of our products, delivery terms and conditions and/or prices please contact your nearest Infineon Technologies office ([www.infineon.com](http://www.infineon.com)).

#### Warnings

Due to technical requirements, our products may contain dangerous substances. For information on the types in question please contact your nearest Infineon Technologies office.

Except as otherwise explicitly approved by us in a written document signed by authorized representatives of Infineon Technologies, our products may not be used in any life endangering applications, including but not limited to medical, nuclear, military, life critical or any other applications where a failure of the product or any consequences of the use thereof can result in personal injury.

# Where to buy

Infiniteon distribution partners and sales offices:

[www.infineon.com/WhereToBuy](http://www.infineon.com/WhereToBuy)

# Service hotline

Infiniteon offers its toll-free 0800/4001 service hotline as one central number, available 24/7 in English, Mandarin and German.

- > Germany ..... 0800 951 951 951 (German/English)
- > China, mainland ..... 4001 200 951 (Mandarin/English)
- > India ..... 000 800 4402 951 (English)
- > USA ..... 1-866 951 9519 (English/German)
- > Other countries ..... 00\* 800 951 951 951 (English/German)
- > Direct access ..... +49 89 234-0 (interconnection fee, German/English)

\* Please note: Some countries may require you to dial a code other than "00" to access this international number.  
Please visit [www.infineon.com/service](http://www.infineon.com/service) for your country!



Mobile product catalog

Mobile app for iOS and Android.

[www.infineon.com](http://www.infineon.com)

Published by  
Infineon Technologies AG  
81726 Munich, Germany

© 2016 Infineon Technologies AG.  
All Rights Reserved.

Order Number: B158-I0090-V2-7600-EU-EC-P  
Date: 09 / 2016

### Please note!

THIS DOCUMENT IS FOR INFORMATION PURPOSES ONLY AND ANY INFORMATION GIVEN HEREIN SHALL IN NO EVENT BE REGARDED AS A WARRANTY, GUARANTEE OR DESCRIPTION OF ANY FUNCTIONALITY, CONDITIONS AND/OR QUALITY OF OUR PRODUCTS OR ANY SUITABILITY FOR A PARTICULAR PURPOSE. WITH REGARD TO THE TECHNICAL SPECIFICATIONS OF OUR PRODUCTS, WE KINDLY ASK YOU TO REFER TO THE RELEVANT PRODUCT DATA SHEETS PROVIDED BY US. OUR CUSTOMERS AND THEIR TECHNICAL DEPARTMENTS ARE REQUIRED TO EVALUATE THE SUITABILITY OF OUR PRODUCTS FOR THE INTENDED APPLICATION.

WE RESERVE THE RIGHT TO CHANGE THIS DOCUMENT AND/OR THE INFORMATION GIVEN HEREIN AT ANY TIME.

### Additional information

For further information on technologies, our products, the application of our products, delivery terms and conditions and/or prices, please contact your nearest Infineon Technologies office ([www.infineon.com](http://www.infineon.com)).



### Warnings

Due to technical requirements, our products may contain dangerous substances. For information on the types in question, please contact your nearest Infineon Technologies office.



Except as otherwise explicitly approved by us in a written document signed by authorized representatives of Infineon Technologies, our products may not be used in any life-endangering applications, including but not limited to medical, nuclear, military, life-critical or any other applications where a failure of the product or any consequences of the use thereof can result in personal injury.

## Looking for pricing, stock, or lifecycle information?

Click below to explore more details on WIN SOURCE:

-  [View TC234LX32F200FABKXUMA1 on WIN SOURCE](#)
-  [Infineon Technologies Information](#)

## Optimize Your Supply Chain with WIN SOURCE Solutions

-  Global Sourcing Solution
-  Obsolete Management
-  Cost Control Management
-  Shortage Management
-  Alternative Solution
-  Excess Inventory Management