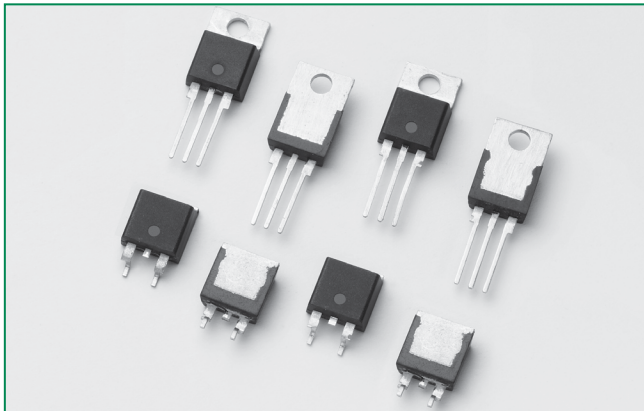




# THE DATASHEET OF S4025NTP



Sxx20x & Sxx25x Series



**Description**

Excellent unidirectional switches for phase control applications such as heating and motor speed controls. Standard phase control SCRs are triggered with few milliamperes of current at less than 1.5V potential.

**Features & Benefits**

- RoHS-compliant
- Glass – passivated junctions
- Voltage capability up to 1000 V
- Surge capability up to 350 A
- Available in isolated TO-220, non-isolated TO-220 and TO-263 packages.

**Agency Approval**

Agency	Agency File Number
	E71639*

\* - L Package Only

**Applications**

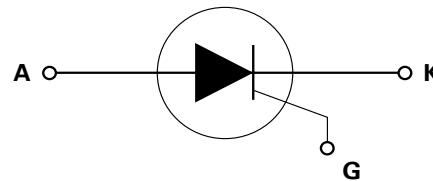
Typical applications are AC solid-state switches, industrial power tools, exercise equipment, white goods and commercial appliances.

Internally constructed isolated packages are offered for ease of heat sinking with highest isolation voltage.

**Main Features**

Symbol	Value	Unit
$I_{T(RMS)}$	20 & 25	A
$V_{DRM}/V_{RRM}$	400 to 1000	V
$I_{GT}$	30 to 35	mA

**Schematic Symbol**



**Additional Information**



Datasheet



Resources



Samples

**Absolute Maximum Ratings – 20A SCR**

Symbol	Parameter	Test Conditions	Value	Unit
$I_{T(RMS)}$	RMS on-state current	$T_c = 80^\circ\text{C}$	20	A
$I_{T(AV)}$	Average on-state current	Sxx20x & Sxx20L $T_c = 80^\circ\text{C}$	12.8	A
$I_{TSM}$	Peak non-repetitive surge current	single half cycle; $f = 50\text{Hz}$ ; $T_j(\text{initial}) = 25^\circ\text{C}$	255	A
		single half cycle; $f = 60\text{Hz}$ ; $T_j(\text{initial}) = 25^\circ\text{C}$	300	
$I^2t$	$I^2t$ Value for fusing	$t_p = 8.3 \text{ms}$	374	$\text{A}^2\text{s}$
$di/dt$	Critical rate of rise of on-state current	$f = 60\text{Hz}$ ; $T_j = 125^\circ\text{C}$	125	$\text{A}/\mu\text{s}$
$I_{GM}$	Peak gate current	$T_j = 125^\circ\text{C}$	3	A
$P_{G(AV)}$	Average gate power dissipation	$T_j = 125^\circ\text{C}$	0.6	W
$T_{stg}$	Storage temperature range		-40 to 150	$^\circ\text{C}$
$T_j$	Operating junction temperature range		-40 to 125	$^\circ\text{C}$

### Absolute Maximum Ratings — 25A SCR

Symbol	Parameter	Test Conditions	Value	Unit
$I_{T(RMS)}$	RMS on-state current	Sxx25L: $T_C = 75^\circ\text{C}$	25	A
		Sxx25R/Sxx25N: $T_C = 100^\circ\text{C}$		
$I_{T(AV)}$	Average on-state current	Sxx25L $T_C = 75^\circ\text{C}$	16	A
		Sxx25R/Sxx25N $T_C = 100^\circ\text{C}$		
$I_{TSM}$	Peak non-repetitive surge current	single half cycle; $f = 50\text{Hz}$ ; $T_J$ (initial) = $25^\circ\text{C}$	300	A
		single half cycle; $f = 60\text{Hz}$ ; $T_J$ (initial) = $25^\circ\text{C}$	350	
$I^2t$	$I^2t$ Value for fusing	$t_p = 8.3 \text{ ms}$	510	$\text{A}^2\text{s}$
$di/dt$	Critical rate of rise of on-state current	$f = 60\text{Hz}$ ; $T_J = 125^\circ\text{C}$	150	$\text{A}/\mu\text{s}$
$I_{GM}$	Peak gate current	$T_J = 125^\circ\text{C}$	3.5	A
$P_{G(AV)}$	Average gate power dissipation	$T_J = 125^\circ\text{C}$	0.8	W
$T_{stg}$	Storage temperature range		-40 to 150	$^\circ\text{C}$
$T_J$	Operating junction temperature range		-40 to 125	$^\circ\text{C}$

### Electrical Characteristics ( $T_J = 25^\circ\text{C}$ , unless otherwise specified)

Symbol	Test Conditions			Value		Unit
				Sxx20L	Sxx25x	
$I_{GT}$	$V_D = 12\text{V}$ $R_L = 30 \Omega$	-	MAX.	30	35	mA
		-	MIN.	1	1	
$V_{GT}$	$V_D = 12\text{V}$ $R_L = 30 \Omega$	-	MAX.	1.5		V
$dv/dt$	$V_D = V_{DRM}$ ; gate open; $T_J = 100^\circ\text{C}$	400V	MIN.	450		V/ $\mu\text{s}$
		600V		425		
		800V		400		
		1000V		200		
	$V_D = V_{DRM}$ ; gate open; $T_J = 125^\circ\text{C}$	400V	350			
		600V	325			
800V		300				
$V_{GD}$	$V_D = V_{DRM}$ $R_L = 3.3 \text{ k}\Omega$ $T_J = 125^\circ\text{C}$	-	MIN.	0.2		V
$I_H$	$I_T = 400\text{mA}$ (initial)	-	MAX.	40	50	mA
$t_q$	(1)	-	MAX.	35		$\mu\text{s}$
$t_{gt}$	$I_G = 2 \times I_{GT}$ $\text{PW} = 15\mu\text{s}$ $I_T = 40\text{A}$	-	TYP.	2		$\mu\text{s}$

Note: xx = voltage, x = package

(1)  $I_T = 2\text{A}$ ;  $t_p = 50\mu\text{s}$ ;  $dv/dt = 5\text{V}/\mu\text{s}$ ;  $di/dt = 30\text{A}/\mu\text{s}$

**Static Characteristics**

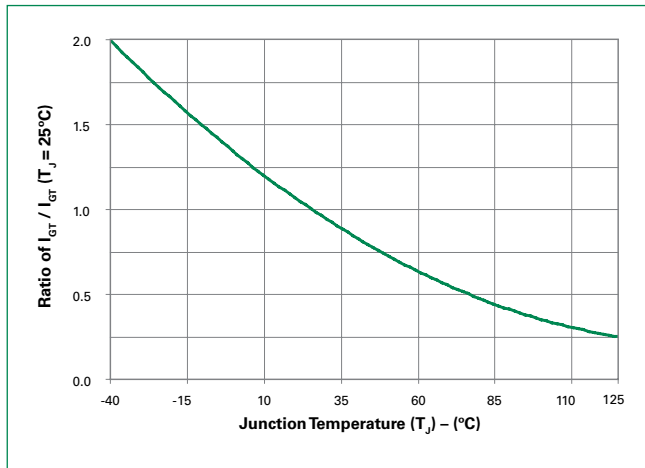
Symbol	Test Conditions		Value	Unit		
$V_{TM}$	20A Device $I_T = 40A$ ; $t_p = 380\mu s$		MAX.	1.6	V	
	25A Device $I_T = 50A$ ; $t_p = 380\mu s$					
$I_{DRM} / I_{RRM}$	$V_{DRM} / V_{RRM}$	$T_J = 25^\circ C$	MAX.	400 – 600V	10	$\mu A$
				800 – 1000V	20	
				400 – 600V	500	
		$T_J = 100^\circ C$	800V	1000		
			1000V	3000		
			400 – 600V	1000		
		$T_J = 125^\circ C$	800V	2000		

**Thermal Resistances**

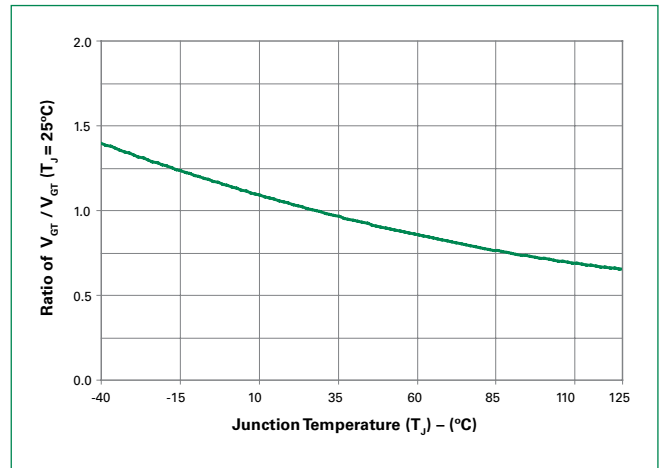
Symbol	Parameter	Value	Unit	
$R_{\theta(J-C)}$	Junction to case (AC)	Sxx25R / Sxx25N	1.0	$^\circ C/W$
		Sxx20L / Sxx25L	2.4	
$R_{\theta(J-A)}$	Junction to ambient	Sxx25R	40	$^\circ C/W$
		Sxx20L / Sxx25L	50	

Note: xx = voltage

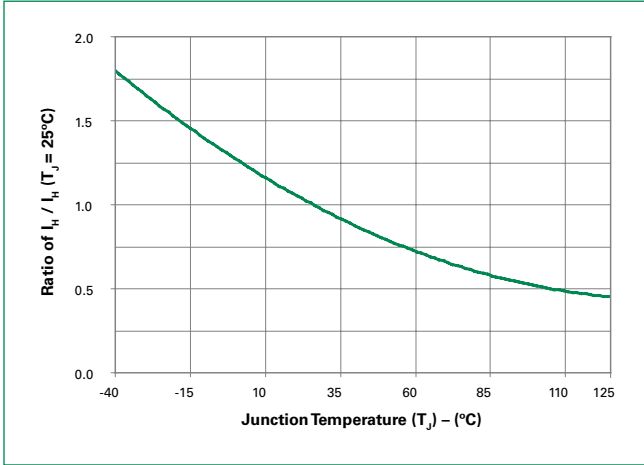
**Figure 1: Normalized DC Gate Trigger Current vs. Junction Temperature**



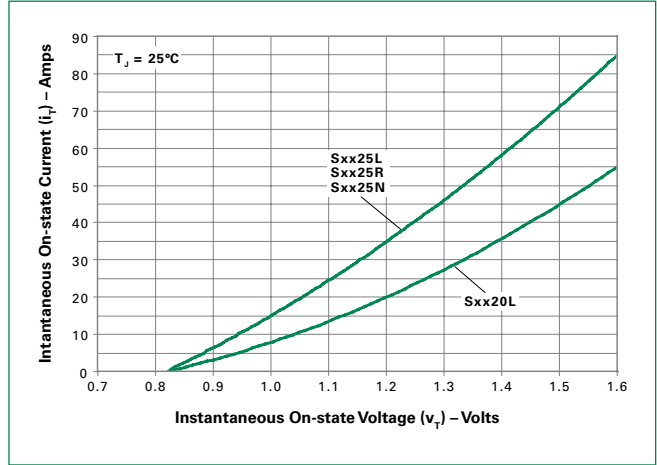
**Figure 2: Normalized DC Gate Trigger Voltage vs. Junction Temperature**



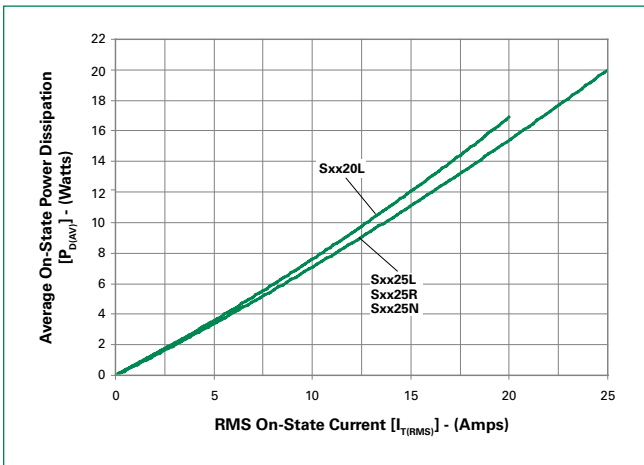
**Figure 3: Normalized DC Holding Current vs. Junction Temperature**



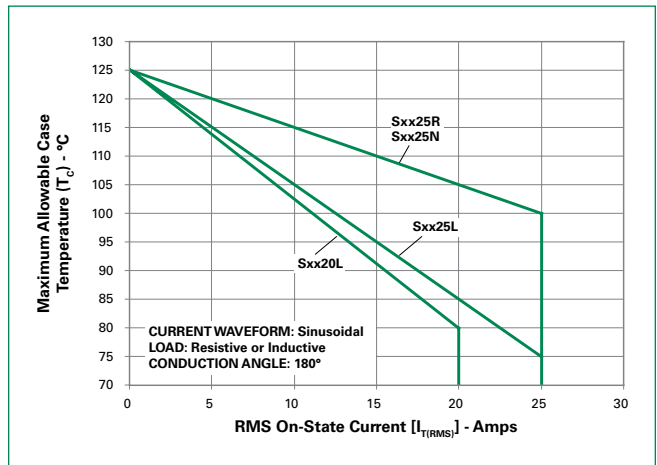
**Figure 4: On-State Current vs. On-State Voltage (Typical)**



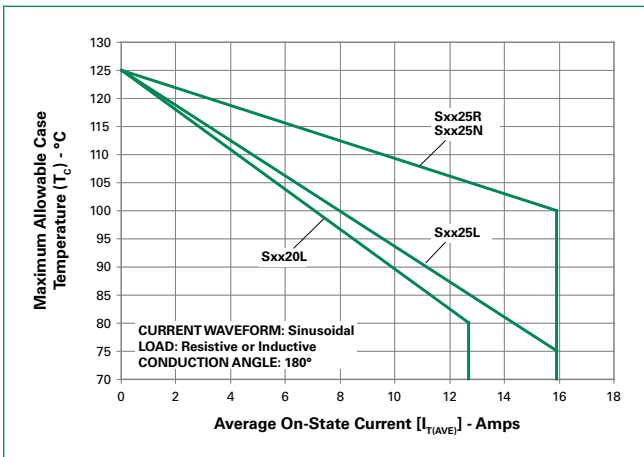
**Figure 5: Power Dissipation (Typical) vs. RMS On-State Current**



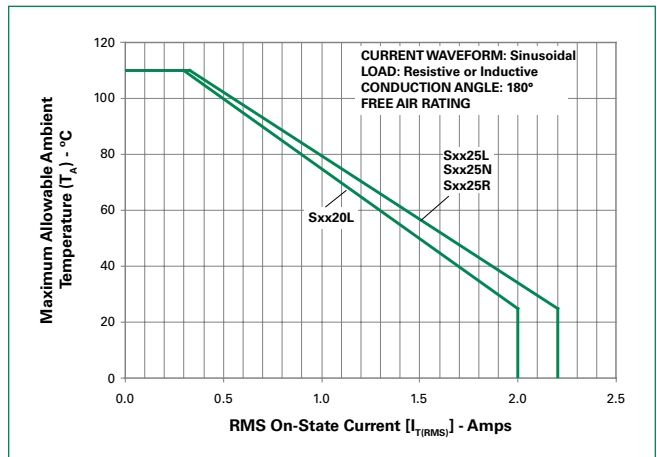
**Figure 6: Maximum Allowable Case Temperature vs. RMS On-State Current**



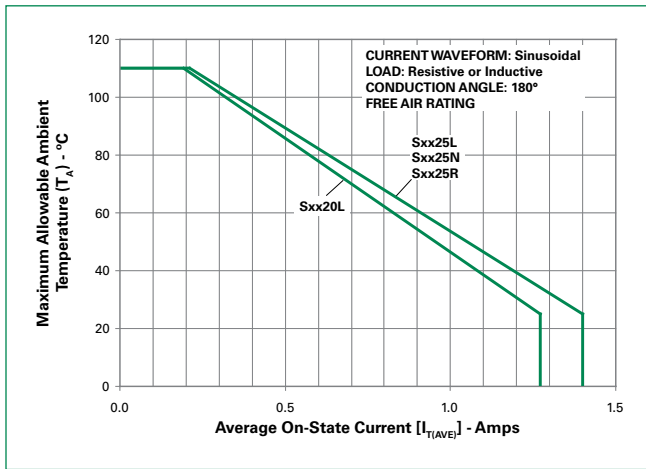
**Figure 7: Maximum Allowable Case Temperature vs. Average On-State Current**



**Figure 8: Maximum Allowable Ambient Temperature vs. RMS On-State Current**

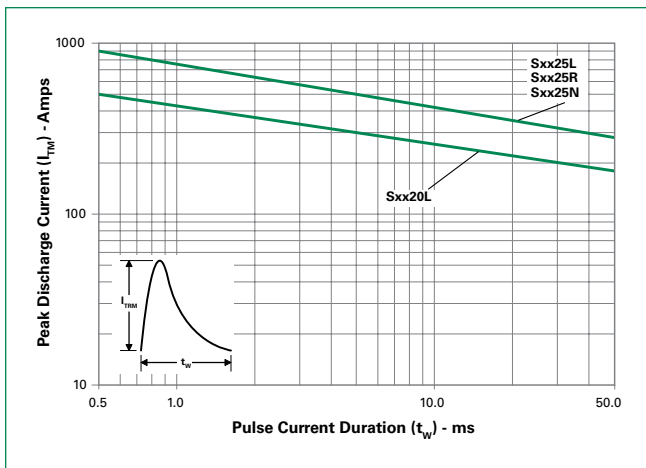


**Figure 9: Maximum Allowable Ambient Temperature vs. Average On-State Current**

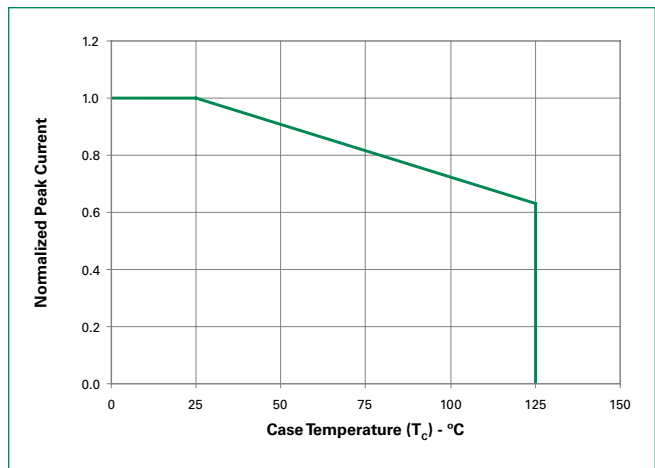


Note: xx = voltage

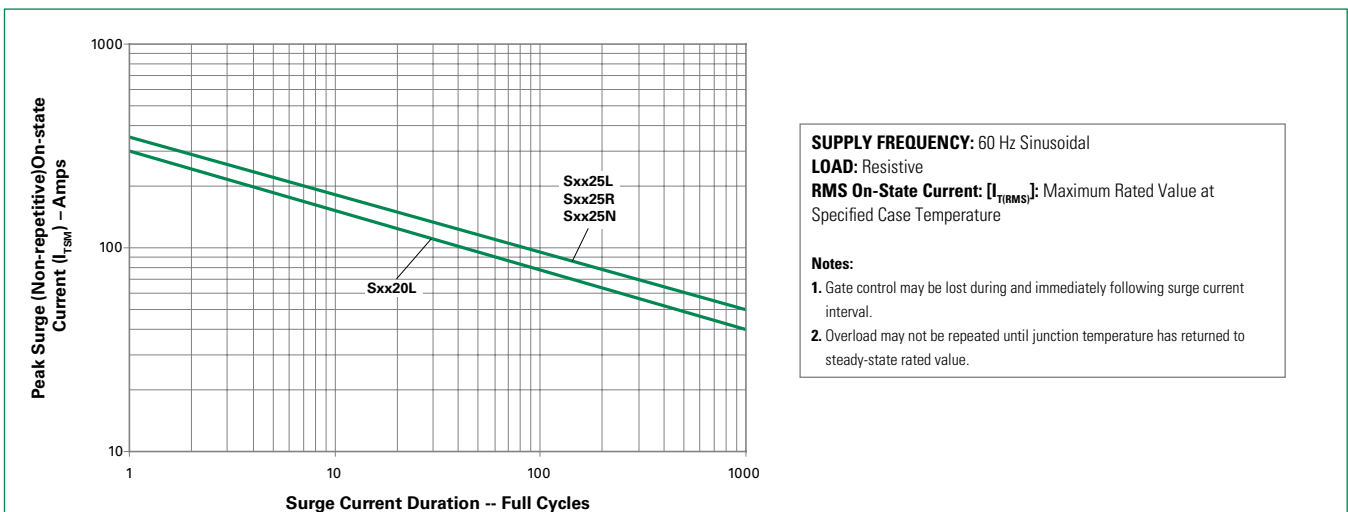
**Figure 10: Peak Capacitor Discharge Current**



**Figure 11: Peak Capacitor Discharge Current Derating**

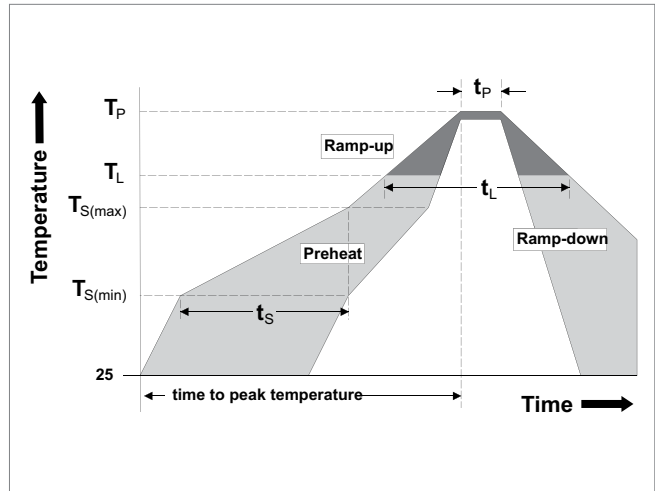


**Figure 12: Surge Peak On-State Current vs. Number of Cycles**



**Soldering Parameters**

<b>Reflow Condition</b>		Pb – Free assembly
<b>Pre Heat</b>	- Temperature Min ( $T_{s(min)}$ )	150°C
	- Temperature Max ( $T_{s(max)}$ )	200°C
	- Time (min to max) ( $t_s$ )	60 – 180 secs
<b>Average ramp up rate (Liquidus Temp) (<math>T_L</math>) to peak</b>		5°C/second max
<b><math>T_{s(max)}</math> to <math>T_L</math> - Ramp-up Rate</b>		5°C/second max
<b>Reflow</b>	- Temperature ( $T_L$ ) (Liquidus)	217°C
	- Temperature ( $t_L$ )	60 – 150 seconds
<b>Peak Temperature (<math>T_p</math>)</b>		260 <sup>+0/-5</sup> °C
<b>Time within 5°C of actual peak Temperature (<math>t_p</math>)</b>		20 – 40 seconds
<b>Ramp-down Rate</b>		5°C/second max
<b>Time 25°C to peak Temperature (<math>T_p</math>)</b>		8 minutes Max.
<b>Do not exceed</b>		280°C



**Physical Specifications**

<b>Terminal Finish</b>	100% Matte Tin-plated
<b>Body Material</b>	UL recognized epoxy meeting flammability classification 94V-0
<b>Lead Material</b>	Copper Alloy

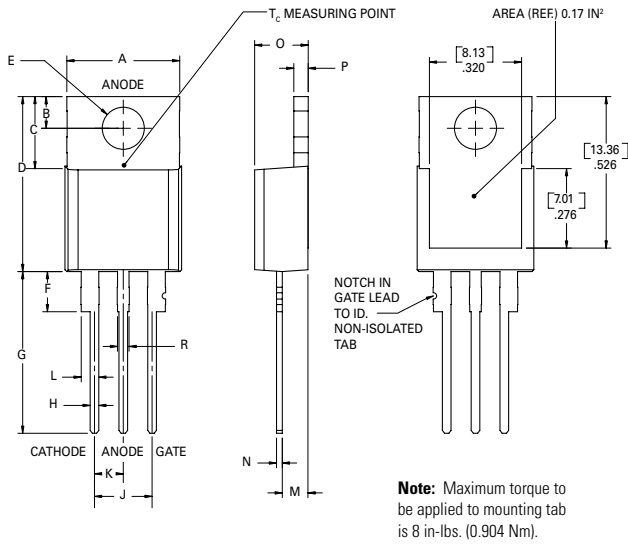
**Design Considerations**

Careful selection of the correct device for the application's operating parameters and environment will go a long way toward extending the operating life of the Thyristor. Good design practice should limit the maximum continuous current through the main terminals to 75% of the device rating. Other ways to ensure long life for a power discrete semiconductor are proper heat sinking and selection of voltage ratings for worst case conditions. Overheating, overvoltage (including dv/dt), and surge currents are the main killers of semiconductors. Correct mounting, soldering, and forming of the leads also help protect against component damage.

**Environmental Specifications**

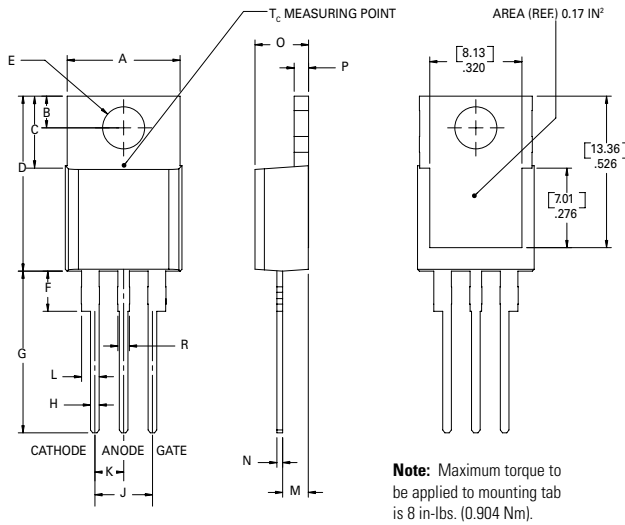
Test	Specifications and Conditions
<b>AC Blocking</b>	MIL-STD-750, M-1040, Cond A Applied Peak AC voltage @ 125°C for 1008 hours
<b>Temperature Cycling</b>	MIL-STD-750, M-1051, 100 cycles; -40°C to +150°C; 15-min dwell-time
<b>Temperature/Humidity</b>	EIA / JEDEC, JESD22-A101 1008 hours; 320V - DC: 85°C; 85% rel humidity
<b>High Temp Storage</b>	MIL-STD-750, M-1031, 1008 hours; 150°C
<b>Low-Temp Storage</b>	1008 hours; -40°C
<b>Resistance to Solder Heat</b>	MIL-STD-750 Method 2031
<b>Solderability</b>	ANSI/J-STD-002, category 3, Test A
<b>Lead Bend</b>	MIL-STD-750, M-2036 Cond E

**Dimensions — TO-220AB (R-Package) — Non-Isolated Mounting Tab Common with Center Lead**



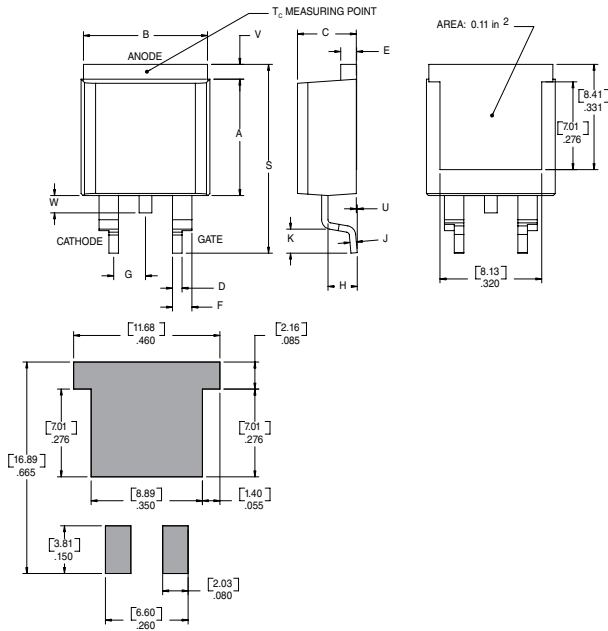
Dimension	Inches		Millimeters	
	Min	Max	Min	Max
A	0.380	0.420	9.65	10.67
B	0.105	0.115	2.67	2.92
C	0.230	0.250	5.84	6.35
D	0.590	0.620	14.99	15.75
E	0.142	0.147	3.61	3.73
F	0.110	0.130	2.79	3.30
G	0.540	0.575	13.72	14.61
H	0.025	0.035	0.64	0.89
J	0.195	0.205	4.95	5.21
K	0.095	0.105	2.41	2.67
L	0.060	0.075	1.52	1.91
M	0.085	0.095	2.16	2.41
N	0.018	0.024	0.46	0.61
O	0.178	0.188	4.52	4.78
P	0.045	0.060	1.14	1.52
R	0.038	0.048	0.97	1.22

**Dimensions — TO-220AB (L-Package) — Isolated Mounting Tab**



Dimension	Inches		Millimeters	
	Min	Max	Min	Max
A	0.380	0.420	9.65	10.67
B	0.105	0.115	2.67	2.92
C	0.230	0.250	5.84	6.35
D	0.590	0.620	14.99	15.75
E	0.142	0.147	3.61	3.73
F	0.110	0.130	2.79	3.30
G	0.540	0.575	13.72	14.61
H	0.025	0.035	0.64	0.89
J	0.195	0.205	4.95	5.21
K	0.095	0.105	2.41	2.67
L	0.060	0.075	1.52	1.91
M	0.085	0.095	2.16	2.41
N	0.018	0.024	0.46	0.61
O	0.178	0.188	4.52	4.78
P	0.045	0.060	1.14	1.52
R	0.038	0.048	0.97	1.22

**Dimensions –TO- 263AB (N-package) – D<sup>2</sup>-Pak Surface Mount**



Dimension	Inches		Millimeters	
	Min	Max	Min	Max
A	0.360	0.370	9.14	9.40
B	0.380	0.420	9.65	10.67
C	0.178	0.188	4.52	4.78
D	0.025	0.035	0.64	0.89
E	0.045	0.060	1.14	1.52
F	0.060	0.075	1.52	1.91
G	0.095	0.105	2.41	2.67
H	0.092	0.102	2.34	2.59
J	0.018	0.024	0.46	0.61
K	0.090	0.110	2.29	2.79
S	0.590	0.625	14.99	15.88
V	0.035	0.045	0.89	1.14
U	0.002	0.010	0.05	0.25
W	0.040	0.070	1.016	1.78

**Product Selector**

Part Number	Voltage				Gate Sensitivity	Type	Package
	400V	600V	800V	1000V			
Sxx20L	X	X	X	X	30mA	Standard SCR	TO-220L
Sxx25L	X	X	X	X	35mA	Standard SCR	TO-220L
Sxx25R	X	X	X	X	35mA	Standard SCR	TO-220R
Sxx25N	X	X	X	X	35mA	Standard SCR	TO-263

Note: xx = Voltage

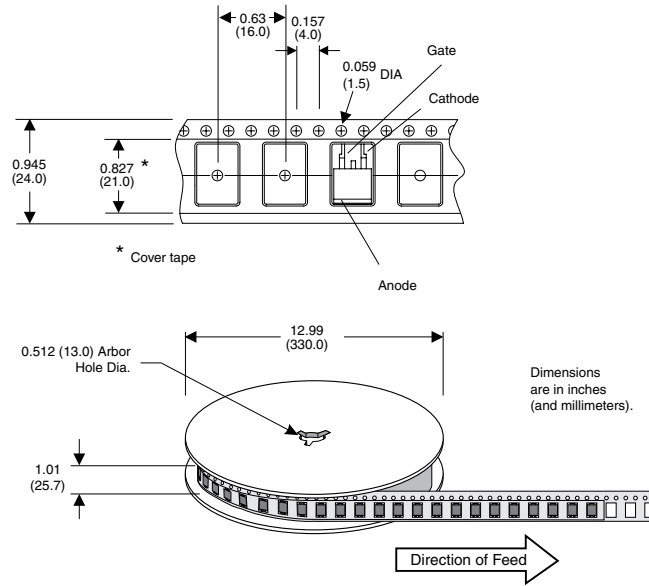
**Packing Options**

Part Number	Marking	Weight	Packing Mode	Base Quantity
Sxx20LTP	Sxx20L	2.2g	Tube	1000 (50 per tube)
Sxx25LTP	Sxx25L	2.2g	Tube	1000 (50 per tube)
Sxx25RTP	Sxx25R	2.2g	Tube	1000 (50 per tube)
Sxx25NTP	Sxx25N	1.6g	Tube	1000 (50 per tube)
Sxx25NRP	Sxx25N	1.6g	Embossed Carrier	500

Note: xx = Voltage

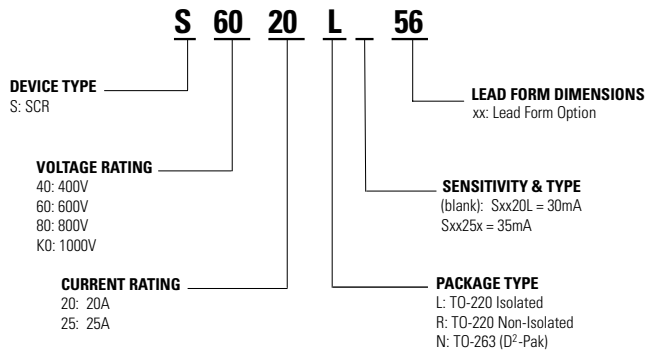
**TO-263 Embossed Carrier Reel Pack (RP) Specifications**

Meets all EIA-481-2 Standards



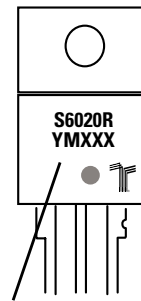
Dimensions are in inches (and millimeters).

**Part Numbering System**



**Part Marking System**

**TO-220 AB - (L and R Package)**  
**TO-263 AB - (N Package)**



Date Code Marking  
Y: Year Code  
M: Month Code  
XXX: Lot Trace Code

## Looking for pricing, stock, or lifecycle information?

Click below to explore more details on WIN SOURCE:

 [View S4025NTP on WIN SOURCE](#)

 [Littelfuse Inc. Information](#)

## Optimize Your Supply Chain with WIN SOURCE Solutions

-  Global Sourcing Solution
-  Obsolete Management
-  Cost Control Management
-  Shortage Management
-  Alternative Solution
-  Excess Inventory Management