



**THE DATASHEET OF  
CDRH125-180MC**



<b>SPECIFICATION</b>		
SUMIDA TYPE	CDRH125	PART NO. REF. TO THE ATTACHED SHEET.

1. DIMENSION (UNIT mm)

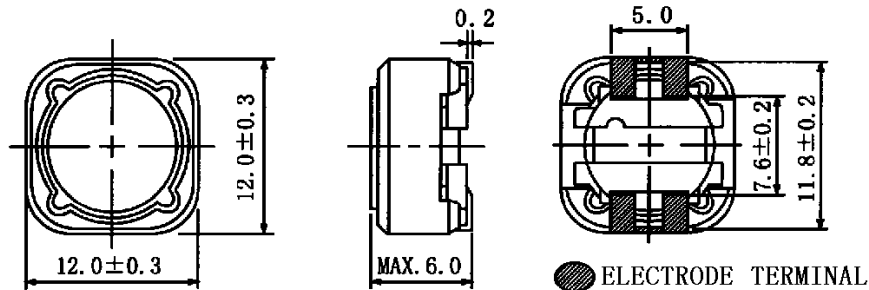

\* DIMENSION WITHOUT TOLERANCE ARE APPROX.

2. CONNECTION (BOTTOM)

3. STAMP (Ex.)

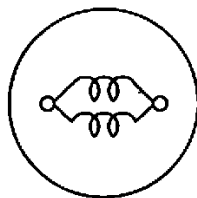

10  $\mu$ H ~ 47  $\mu$ H

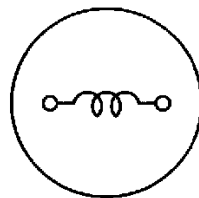

56  $\mu$ H ~ 1 mH

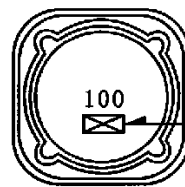

DATE CODE

DIRECTLY STAMP  
UNFIXED THE POSITION

4. NOTE

\* PLEASE DO NOT USE A WASHING AGENT.

\* ENCLOSING CONDITION OF COILS.

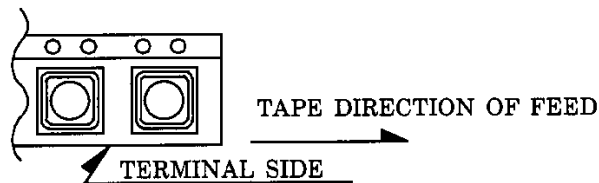

\* CARRIER TAPE PACKING SPECIFICATION IN DETAIL.(S-074-500)

\* RECOMMENDED REFLOW CONDITION TO BE ACCORDING TO S-074-5003.

22 nd JUN . , 1994			SUMIDA CODE	4735	
CHK.	CHK.	DRG.			DRG. NO. 2/5
O.SATO	KOMA ITA	SUZUKI K			S-074-501

TYPE

CDRH125

## GENERAL CHARACTERISTICS

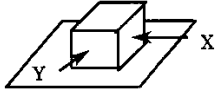
1. STORAGE TEMPERATURE RANGE :  $-40^{\circ}\text{C} \sim +85^{\circ}\text{C}$   $\Delta$
2. OPERATING TEMPERATURE :  $-25 \sim +80^{\circ}\text{C}$  (COIL CONTAIN HEAT)
3. EXTERNAL APPEARANCE : ON VISUAL INSPECTION, THE COIL HAS NO EXTERNAL DEFECTS.
4. ELECTRODE STRENGTH  $\Delta$  : AFTER SOLDERING, BETWEEN COPPER PLATE AND ELECTRODE OF COIL, PUSH IN THREE DIRECTIONS OF X, Y WITHSTANDING 4.9N(0.5kgf) FOR  $10 \pm 2$  SECONDS. ELECTRODE SHOULD NOT PEEL OFF. (REFER TO FIGURE AT RIGHT)
 
5. HEAT ENDURANCE TEST: REFER TO THE S-074-5002.
6. DIELECTRIC STRENGTH : NO APPARENT AT 100V D.C. FOR 1 MINUTE BETWEEN COIL-CORE.
7. INSULATING RESISTANCE : OVER 100 M $\Omega$  AT 100V D.C. BETWEEN COIL-CORE.
8. INDUCTANCE TEMPERATURE COEFFICIENT :  $(0 \sim 2000) \times 10^{-6} / ^{\circ}\text{C}$  ( $-25 \sim +80^{\circ}\text{C}$ )
9. HUMIDITY TEST : INDUCTANCE DEVIATION WITHIN  $\pm 5.0\%$   
AFTER 96 HOURS IN 90~95% RELATIVE HUMIDITY AT  $40 \pm 2^{\circ}\text{C}$  AND 1 HOUR DRYING UNDER NORMAL CONDITION.
10. VIBRATION TEST : INDUCTANCE DEVIATION WITHIN  $\pm 3.0\%$  AFTER VIBRATION FOR 1 HOUR. IN EACH OF THREE ORIENTATIONS AT SWEEP VIBRATION (10~55~10 Hz) WITH 1.5 mm P-P AMPLITUDE.
11. SHOCK TEST : INDUCTANCE DEVIATION WITHIN  $\pm 3.0\%$  AFTER DROP DOWN WITH  $981\text{m/s}^2$ (100G) SHOCK ATTITUDE UPON A RUBBER BLOCK METHOD SHOCK TESTING MACHINE, FOR 1 TIME, IN EACH OF THREE ORIENTATIONS.

7 th DEC . , 1993

CHK.	CHK.	DRG.
O.SATO	SUZUKI	MONMA S

DRG. NO.

3/5

S-074-501

# SPECIFICATION

TYPE	CDRH125
------	---------

## ELECTRICAL CHARACTERISTICS

NO.	PART NO.	STAMP	INDUCTANCE [WITHIN] ※1	D.C.R. (Ω) [MAX.] (at 20°C) (TYPICAL BALUE)	RATED CURRENT (A) ※2	SUMIDA CODE
01	CDRH125-100 MC	100	10 μH ± 20 %	25 m (19 m)	4.00	-0001
02	CDRH125-120 MC	120	12 μH ± 20 %	27 m (21 m)	3.50	-0012
03	CDRH125-150 MC	150	15 μH ± 20 %	30 m (23 m)	3.30	-0023
04	CDRH125-180 MC	180	18 μH ± 20 %	34 m (26 m)	3.00	-0034
05	CDRH125-220 MC	220	22 μH ± 20 %	36 m (28 m)	2.80	-0045
06	CDRH125-270 MC	270	27 μH ± 20 %	51 m (39 m)	2.30	-0056
07	CDRH125-330 MC	330	33 μH ± 20 %	57 m (44 m)	2.10	-0067
08	CDRH125-390 MC	390	39 μH ± 20 %	68 m (52 m)	2.00	-0078
09	CDRH125-470 MC	470	47 μH ± 20 %	75 m (58 m)	1.80	-0089
10	CDRH125-560 MC	560	56 μH ± 20 %	0.11 (84 m)	1.70	-0090
11	CDRH125-680 MC	680	68 μH ± 20 %	0.12 (93 m)	1.50	-0101
12	CDRH125-820 MC	820	82 μH ± 20 %	0.14 (0.11)	1.40	-0112
13	CDRH125-101 MC	101	100 μH ± 20 %	0.16 (0.12)	1.30	-0123
14	CDRH125-121 MC	121	120 μH ± 20 %	0.17 (0.13)	1.10	-0134
15	CDRH125-151 MC	151	150 μH ± 20 %	0.23 (0.18)	1.00	-0145
16	CDRH125-181 MC	181	180 μH ± 20 %	0.29 (0.22)	0.90	-0156
17	CDRH125-221 MC	221	220 μH ± 20 %	0.40 (0.31)	0.80	-0167
18	CDRH125-271 MC	271	270 μH ± 20 %	0.46 (0.35)	0.75	-0178
19	CDRH125-331 MC	331	330 μH ± 20 %	0.51 (0.39)	0.68	-0189
20	CDRH125-391 MC	391	390 μH ± 20 %	0.69 (0.53)	0.65	-0191
21	CDRH125-471 MC	471	470 μH ± 20 %	0.77 (0.59)	0.58	-0202
22	CDRH125-561 MC	561	560 μH ± 20 %	0.86 (0.66)	0.54	-0213
23	CDRH125-681 MC	681	680 μH ± 20 %	1.20 (0.92)	0.48	-0224
24	CDRH125-821 MC	821	820 μH ± 20 %	1.34 (1.03)	0.43	-0235
25	CDRH125-102 MC	102	1.0 mH ± 20 %	1.53 (1.18)	0.40	-0246

※1: MEASURED FREQUENCY L at 1 kHz

※2: THIS INDICATES THE VALUE OF CURRENT WHEN THE INDUCTANCE IS 75% MORE THAN IT'S NOMINAL VALUE AND TEMPERATURE RISING  $\Delta t = 40^\circ\text{C}$  LOWER AT D.C. SUPERPOSITION. ( $T_a = 20^\circ\text{C}$ )

7 th DEC . , 1993			SUMIDA CODE	4735
C H K.	C H K.	D R G.	DEG NO. 4/5	
O.SATO	SUZUKI	MONMA S		
			S-074-501	



# SPECIFICATION

TYPE	CDRH125
------	---------

DIMENSION RECOMMENDED (mm)

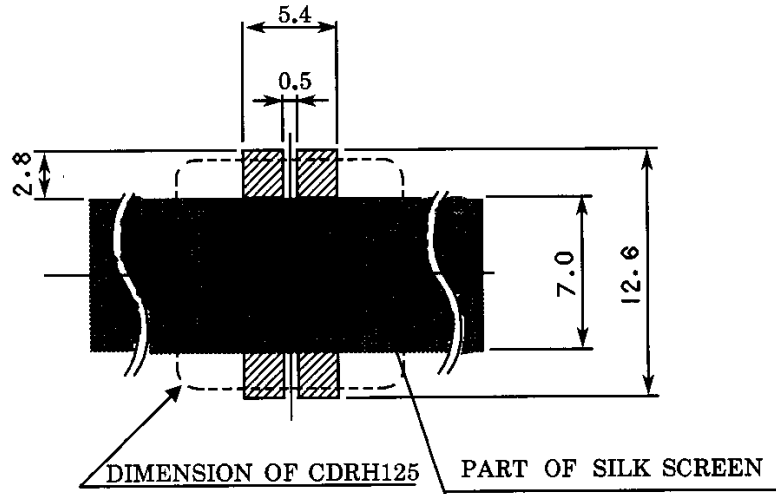

PLEASE COAT WITH SILK BETWEEN ELECTRODE.  $\triangle$

7 th DEC . , 1993

C H K.	C H K.	D R G.
O.SATO	SUZUKI	MONMA S

DRG. NO.	5/5
S-074-501	

## Looking for pricing, stock, or lifecycle information?

Click below to explore more details on WIN SOURCE:

- ⊖ [View CDRH125-180MC on WIN SOURCE](#)
- ⊖ [Sumida America Components Inc. Information](#)

## Optimize Your Supply Chain with WIN SOURCE Solutions

- ✓ Global Sourcing Solution
- ✓ Obsolete Management
- ✓ Cost Control Management
- ✓ Shortage Management
- ✓ Alternative Solution
- ✓ Excess Inventory Management