

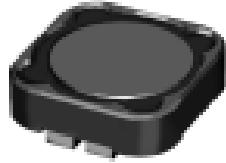

**THE DATASHEET OF
CDRH124NP-470MC**



SMD Power Inductor CDRH124



Description

- Ferrite drum core construction.
- Magnetically shielded.
- L × W × H: 12.3 × 12.3 × 4.5 mm Max.
- Product weight: 2.3g(Ref.)
- Moisture Sensitivity Level: 1
- RoHS compliance.

Environmental Data

- Operating temperature range: -40°C ~ +100°C (including coil's self temperature rise)
- Storage temperature range: -40°C ~ +100°C
- Solder reflow temperature: 260 °C peak.

Packaging

- Carrier tape and reel packaging
- 12.9" diameter reel
- 500pcs per reel

Applications

- Ideally used in Notebook PC, LCD TV, DVD, Game machine, STB, Projector etc as DC-DC converter inductors.

Dimension - [mm]

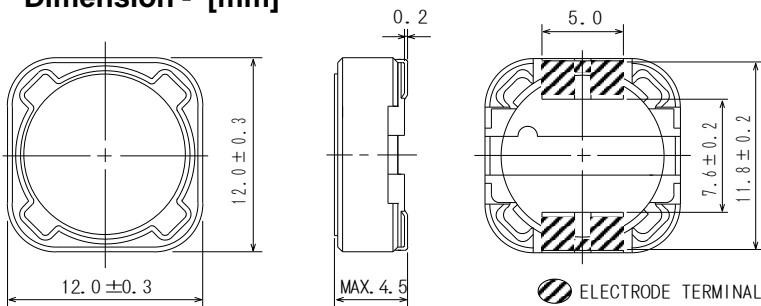

Land pattern and Schematics - [mm]

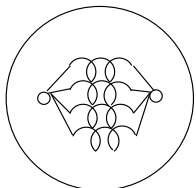
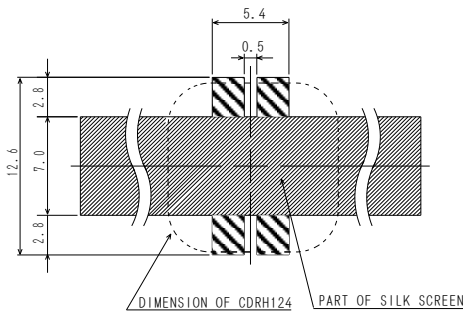

3.9µH~10µH

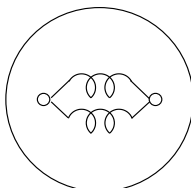

12µH~47µH,
68µH,82µH

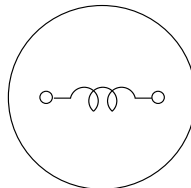

56µH,
100µH~330µH



Electrical Characteristics

Part Name	Stamp	Inductance (μH) [within] ※1	D.C.R. (m Ω) [Max.] (Typ.) (at 20°C)	Rated current (A) ※2
CDRH124NP-3R9MC	3R9	3.9 \pm 20%	15(12)	6.5
CDRH124NP-4R7MC	4R7	4.7 \pm 20%	18(14)	5.7
CDRH124NP-6R8MC	6R8	6.8 \pm 20%	23(18)	4.9
CDRH124NP-8R2MC	8R2	8.2 \pm 20%	26(21)	4.6
CDRH124NP-100MC	100	10 \pm 20%	28(22)	4.5
CDRH124NP-120MC	120	12 \pm 20%	38(30)	4.0
CDRH124NP-150MC	150	15 \pm 20%	50(40)	3.2
CDRH124NP-180MC	180	18 \pm 20%	57(46)	3.1
CDRH124NP-220MC	220	22 \pm 20%	66(53)	2.9
CDRH124NP-270MC	270	27 \pm 20%	80(64)	2.8
CDRH124NP-330MC	330	33 \pm 20%	97(78)	2.7
CDRH124NP-390MC	390	39 \pm 20%	132(106)	2.1
CDRH124NP-470MC	470	47 \pm 20%	150(120)	1.9
CDRH124NP-560MC	560	56 \pm 20%	190(152)	1.8
CDRH124NP-680MC	680	68 \pm 20%	220(176)	1.5
CDRH124NP-820MC	820	82 \pm 20%	260(208)	1.3
CDRH124NP-101MC	101	100 \pm 20%	308(246)	1.2
CDRH124NP-121MC	121	120 \pm 20%	380(304)	1.1
CDRH124NP-151MC	151	150 \pm 20%	530(424)	0.95
CDRH124NP-181MC	181	180 \pm 20%	620(496)	0.85
CDRH124NP-221MC	221	220 \pm 20%	700(560)	0.8
CDRH124NP-271MC	271	270 \pm 20%	870(696)	0.6
CDRH124NP-331MC	331	330 \pm 20%	990(792)	0.5

※1. Inductance measuring condition: at 100 kHz.

※2. Rated current: The DC current at which the inductance decreases to 75% of its nominal value or when $\Delta t=40^\circ\text{C}$, whichever is lower .

SMD Power Inductor CDRH124



Saturation Current & Temperature Rise Graph

— L (20°C) — L (100°C) — ΔT

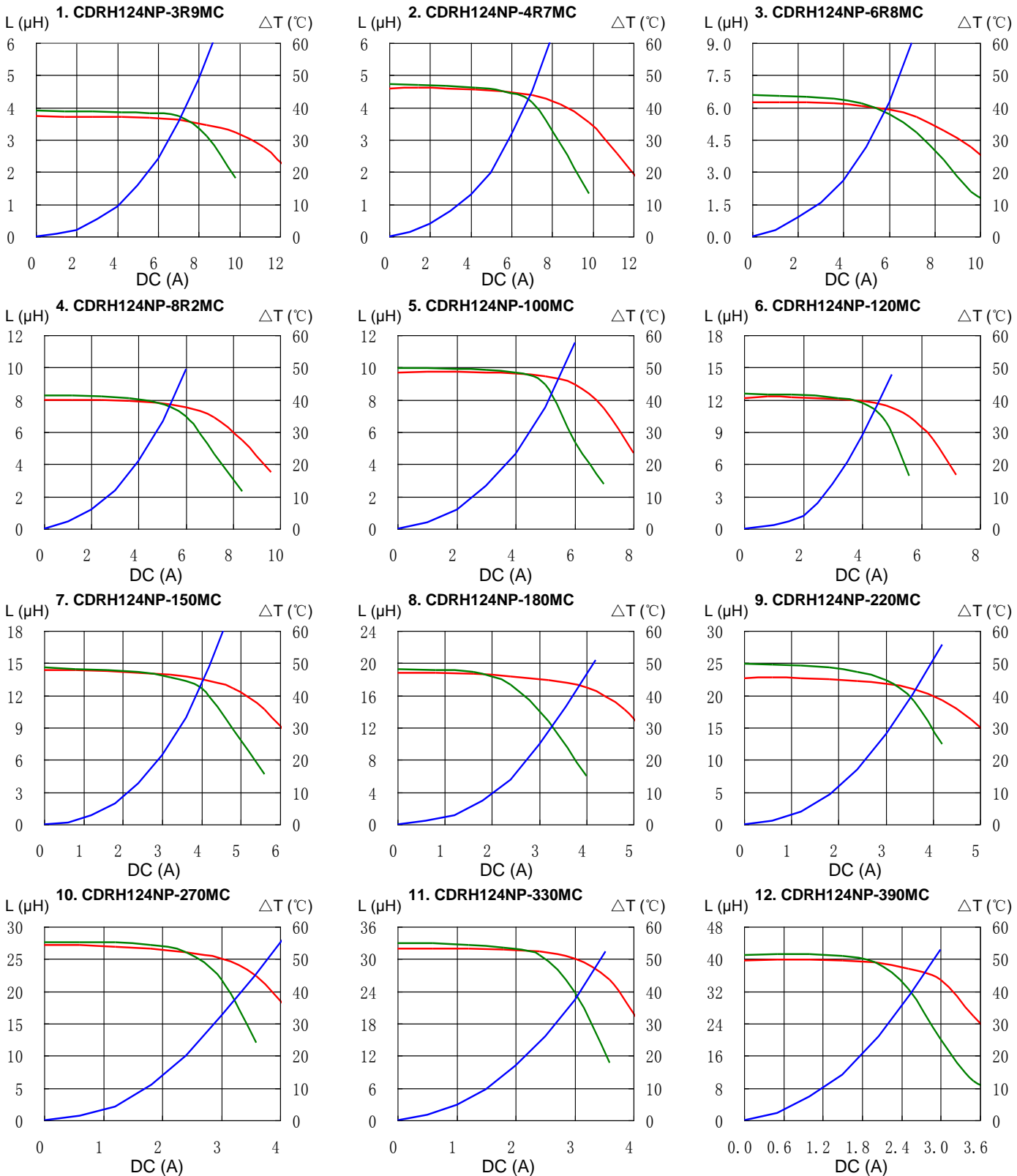

SMD Power Inductor CDRH124



Saturation Current & Temperature Rise Graph

— L (20°C) — L (100°C) — ΔT

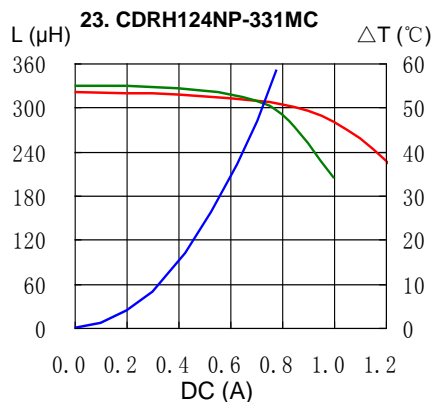
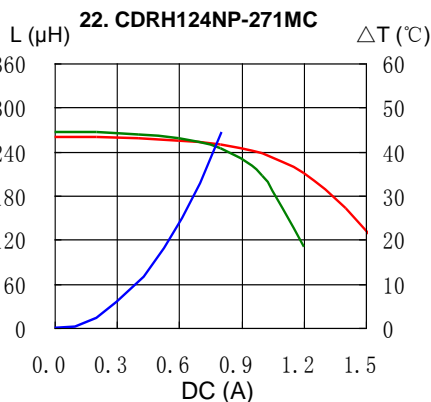
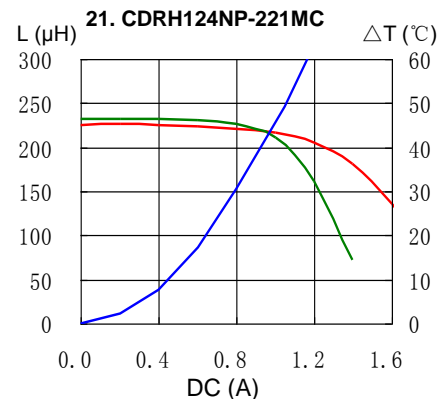
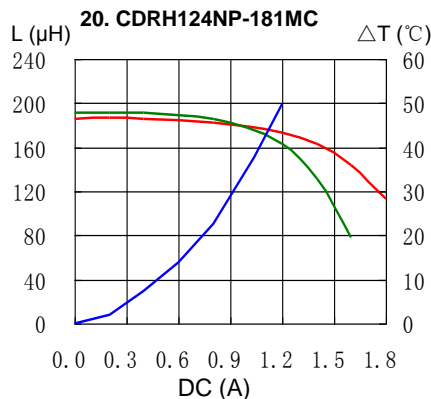
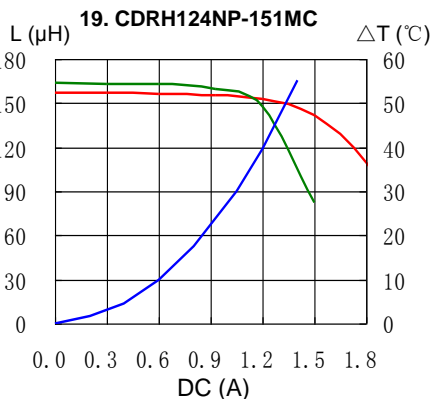
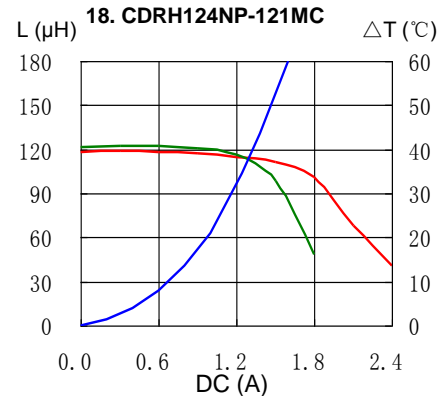
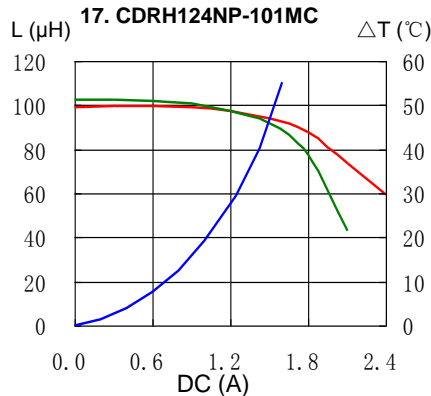
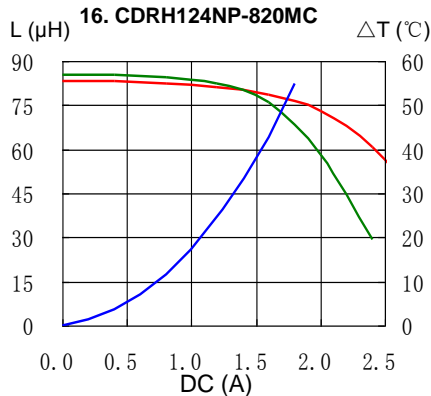
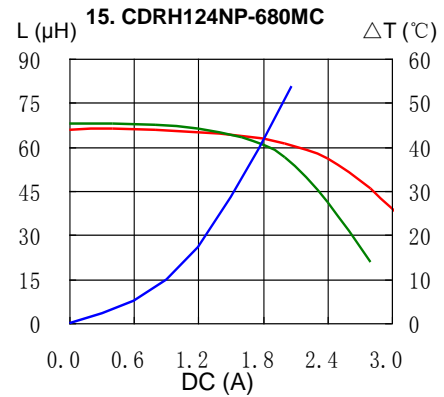
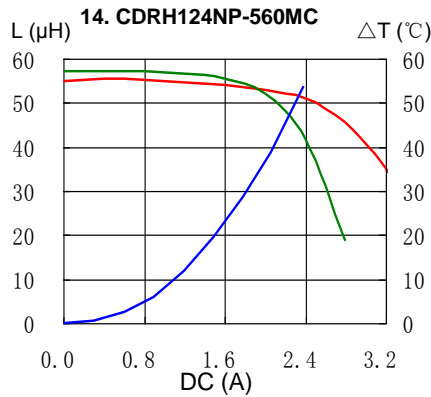
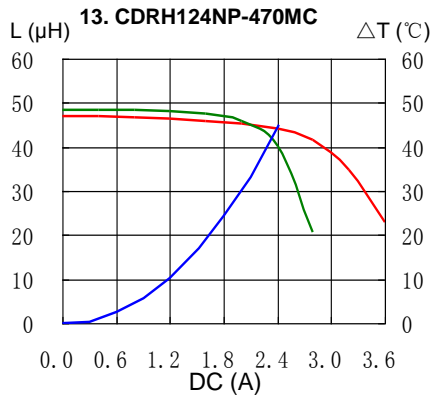

SMD Power Inductor CDRH124



Solder Reflow Condition

Heat Endurance

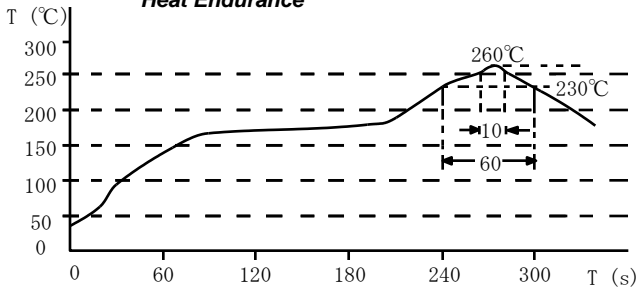

Temperature Chart



Please refer to the sales offices on our website - <http://www.sumida.com>

Hong Kong

Tel.+852-2880-6781
FAX.+852-2565-9600
sales@hk.sumida.com

Saitama(Japan)

Tel.+81-48-691-7300
FAX.+81-48-691-7340
sales@jp.sumida.com

Chicago

Tel.+1-847-545-6700
FAX. +1-847-545-6720
sales@us.sumida.com

Shanghai

Tel.+86-21-5836-3299
FAX.+86-21-5836-3266
shanghai.sales@cn.sumida.com

Seoul

Tel.+82-2-6237-0777
FAX.+82-2-6237-0778
sales@kr.sumida.com

Obernzell

Tel.+49-8591-937-0
FAX. +49-8591-937-103
contact@eu.sumida.com

Shenzhen

Tel.+86-755-8291-0228
FAX.+86-755-8291-0338
shenzhen.sales@cn.sumida.com

Singapore

Tel.+65-6296-3388
FAX.+65-6841-4426
sales@sg.sumida.com

Neumarkt

Tel.+49-9181-4509-110
FAX. +49-9181-4509-310
infocomp@eu.sumida.com

Taipei

Tel.+886-2-8751-2737
FAX.+886-2-8751-2738
sales@tw.sumida.com

San Jose

Tel.+1-408-321-9660
FAX.+1-408-321-9308
sales@us.sumida.com

Looking for pricing, stock, or lifecycle information?

Click below to explore more details on WIN SOURCE:

- ⊖ [View CDRH124NP-470MC on WIN SOURCE](#)
- ⊖ [Sumida America Components Inc. Information](#)

Optimize Your Supply Chain with WIN SOURCE Solutions

- ✓ Global Sourcing Solution
- ✓ Obsolete Management
- ✓ Cost Control Management
- ✓ Shortage Management
- ✓ Alternative Solution
- ✓ Excess Inventory Management