

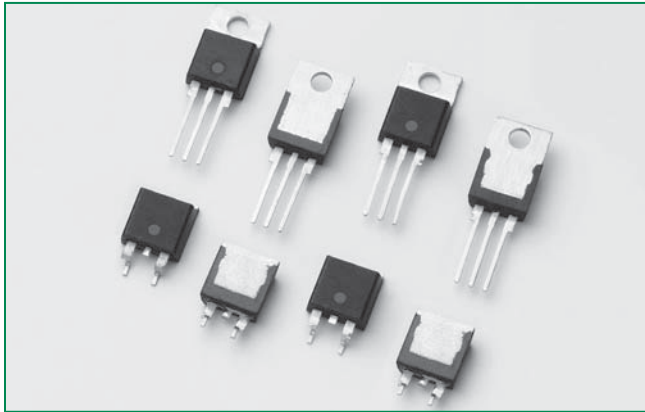

**THE DATASHEET OF
Q6008NH1LEDRP**



Q6008xH1LED Series



Description

Q6008xH1LED series is designed to meet low load current characteristics typical in LED lighting applications.

By keeping holding current at 6mA maximum, this Triac series is characterized and specified to perform best with LED loads. The Q6008xH1LED series is best suited for LED dimming controls to obtain the lowest levels of light output with a minimum probability of flickering.

Agency Approval

Agency	Agency File Number
	L Package: E71639

Main Features

Symbol	Value	Unit
$I_{T(RMS)}$	8	A
V_{DRM}/V_{RRM}	600	V
I_{GT}	10	mA

Schematic Symbol

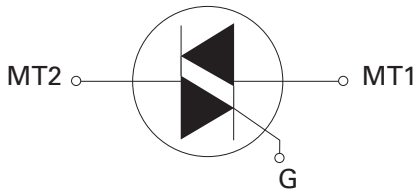

Features

- As low as 6mA max holding current
- L-Package is UL recognized for 2500Vrms
- 110°C rated junction temperature
- di/dt performance of 70A/μs
- QUADRAC version includes intergrated DIAC

Benefits

- Provides full control of light out put at the extreme low end of load conditions.
- 2500V_{AC} min isolation between mounting tab and active terminals
- Improves margin of safe operation with less heat sinking required
- Enable survivability of typically LED load operating characteristics
- Simplicity of circuit design & layout

Applications

Excellent for AC switching and phase control applications such as heating, lighting, and motor speed controls.

Typical applications are AC solid-state switches, lighting controls with LED lamp loads, small low current motor in power tools, and low current motors in home/brown goods appliances.

Internally constructed isolated packages are offered for ease of heat sinking with highest isolation voltage.

Absolute Maximum Ratings

Symbol	Parameter	Test Conditions		Value	Unit
$I_{T(RMS)}$	RMS on-state current (full sine wave)	Q6008LH1LED	$T_C = 80^\circ\text{C}$	8	A
		Q6008RH1LED	$T_C = 95^\circ\text{C}$		
		Q6008NH1LED			
I_{TSM}	Non repetitive surge peak on-state current (full cycle, T_J initial = 25°C)	f = 50 Hz	t = 20 ms	80	A
		f = 60 Hz	t = 16.7 ms	85	
I^2t	I^2t Value for fusing		$t_p = 8.3$ ms	30	A^2s
di/dt	Critical rate of rise of on-state current	f = 120 Hz	$T_J = 110^\circ\text{C}$	70	$\text{A}/\mu\text{s}$
I_{GTM}	Peak gate trigger current	$t_p \leq 10 \mu\text{s};$ $I_{GT} \leq I_{GTM}$	$T_J = 110^\circ\text{C}$	1.6	A
$P_{G(AV)}$	Average gate power dissipation	$T_J = 110^\circ\text{C}$	$I_{GT} = 35\text{mA}$	0.5	W
T_{stg}	Storage temperature range			-40 to 150	$^\circ\text{C}$
T_J	Operating junction temperature range			-40 to 110	$^\circ\text{C}$

Electrical Characteristics ($T_J = 25^\circ\text{C}$, unless otherwise specified)

Symbol	Test Conditions	Quadrant		Value	Unit
I_{GT}	$V_D = 12\text{V}$ $R_L = 60 \Omega$	I – II – III	MAX.	10	mA
V_{GT}		I – II – III		1.3	V
V_{GD}	$V_D = V_{DRM}$ $R_L = 3.3 \text{ k}\Omega$ $T_J = 110^\circ\text{C}$	I – II – III	MIN.	0.2	V
I_H	$I_T = 15\text{mA}$		MAX.	6	mA
dv/dt	$V_D = V_{DRM}$ Gate Open $T_J = 110^\circ\text{C}$		MIN.	50	$\text{V}/\mu\text{s}$
(dv/dt)c	(di/dt)c = 4.3 A/ms $T_J = 110^\circ\text{C}$		MIN.	10	$\text{V}/\mu\text{s}$
t_{gt}	$I_G = 100\text{mA}$ $\text{PW} = 15\mu\text{s}$ $I_T = 11.3 \text{ A(pk)}$		TYP.	4.0	μs

Static Characteristics

Symbol	Test Conditions		Value	Unit	
V_{TM}	$I_{TM} = 11.3\text{A}$ $t_p = 380 \mu\text{s}$		MAX.	1.60	V
I_{DRM} I_{RRM}	$V_{DRM} = V_{RRM}$	$T_J = 110^\circ\text{C}$	MAX.	500	μA

Thermal Resistances

Symbol	Parameter	Value	Unit
$R_{\theta(J-C)}$	Junction to case (AC)	Q6008LH1LED	2.8
		Q6008RH1LED	1.5
		Q6008NH1LED	

Figure 1: Definition of Quadrants

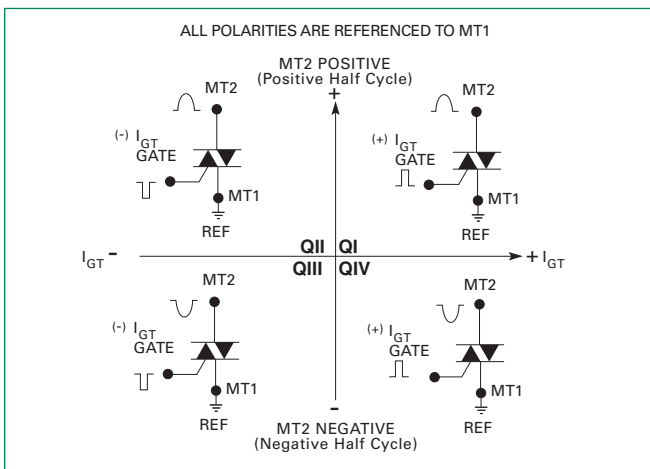

Note: Alternistors will not operate in QIV

Figure 2: Normalized DC Gate Trigger Current for All Quadrants vs. Junction Temperature

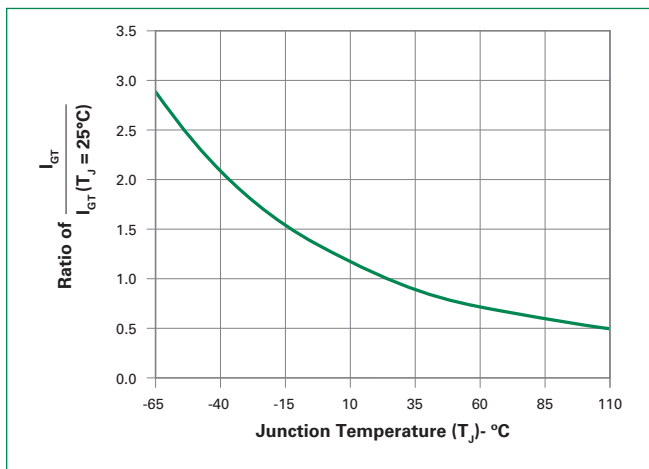

Figure 3: Normalized DC Holding Current vs. Junction Temperature

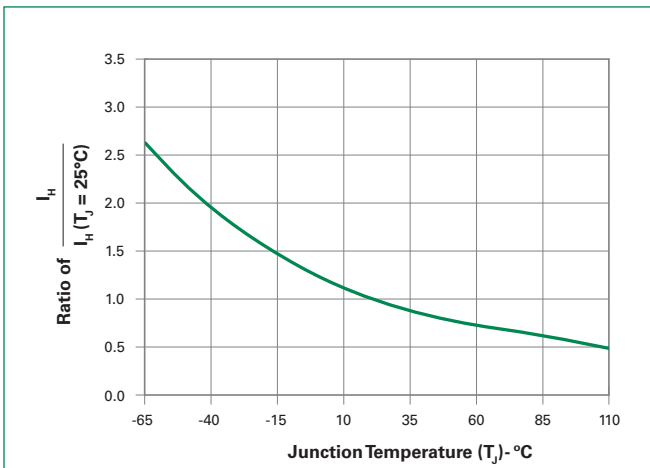

Figure 4: Normalized DC Gate Trigger Voltage for All Quadrants vs. Junction Temperature

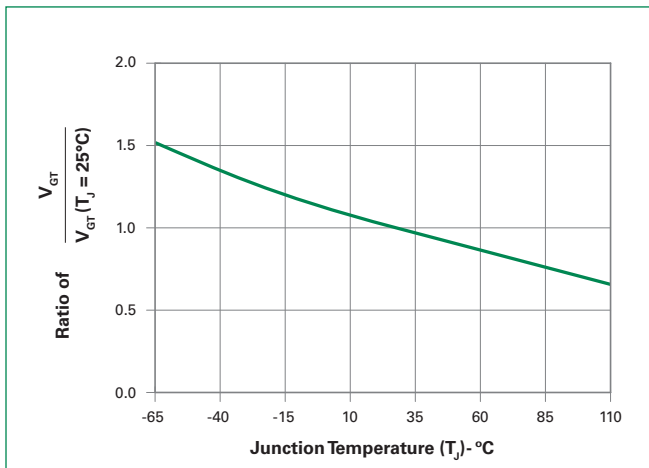

Figure 5: Power Dissipation (Typical) vs. RMS On-State Current

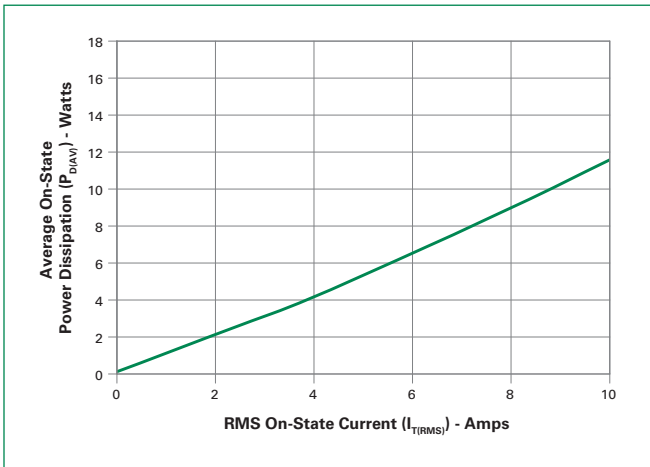

Figure 6: Maximum Allowable Case Temperature vs. On-State Current (Standard / Alternistor Triac)

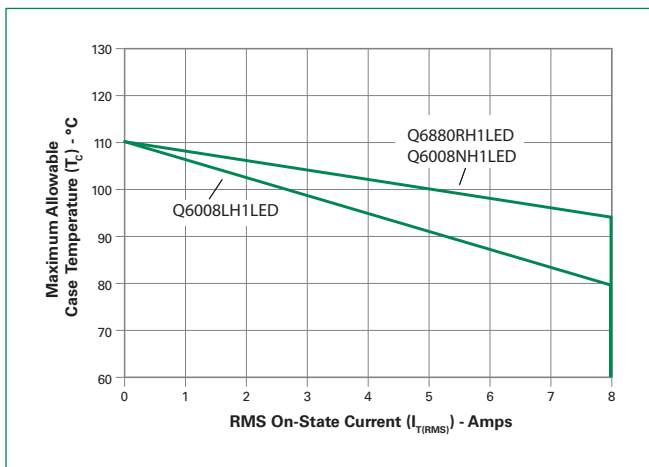

Figure 7: On-State Current vs. On-State Voltage (Typical)

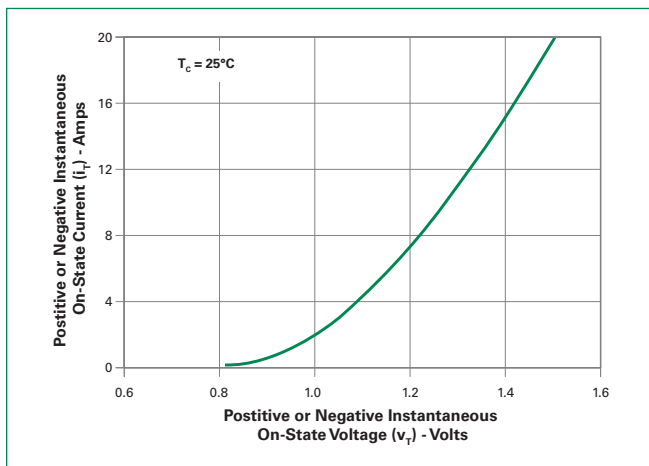
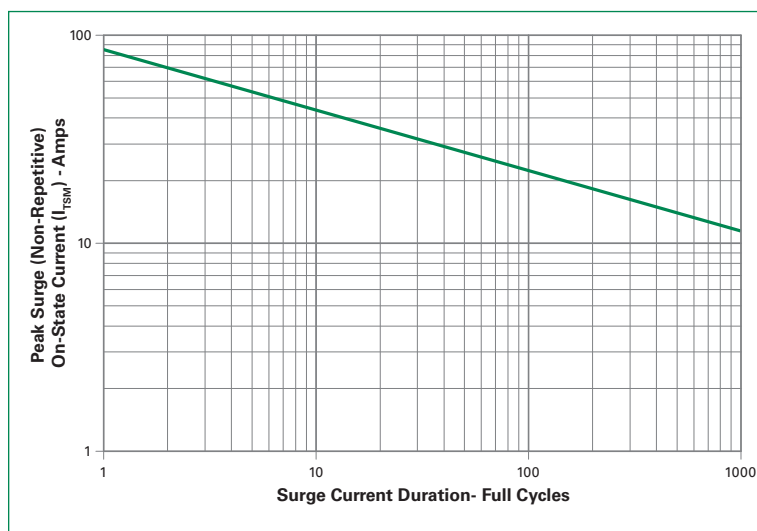

Figure 8: Surge Peak On-State Current vs. Number of Cycles



SUPPLY FREQUENCY: 60 Hz Sinusoidal
LOAD: Resistive
RMS On-State Current: [I_{TRMS}]: Maximum Rated Value at Specified Case Temperature

- Notes:
1. Gate control may be lost during and immediately following surge current interval.
 2. Overload may not be repeated until junction temperature has returned to steady-state rated value.

Soldering Parameters

Reflow Condition		Pb – Free assembly
Pre Heat	- Temperature Min ($T_{s(min)}$)	150°C
	- Temperature Max ($T_{s(max)}$)	200°C
	- Time (min to max) (t_s)	60 – 180 secs
Average ramp up rate (Liquidus Temp (T_L) to peak)		5°C/second max
$T_{s(max)}$ to T_L - Ramp-up Rate		5°C/second max
Reflow	- Temperature (T_L) (Liquidus)	217°C
	- Temperature (t_L)	60 – 150 seconds
Peak Temperature (T_p)		260 ^{+0/-5} °C
Time within 5°C of actual peak Temperature (t_p)		20 – 40 seconds
Ramp-down Rate		5°C/second max
Time 25°C to peak Temperature (T_p)		8 minutes Max.
Do not exceed		280°C

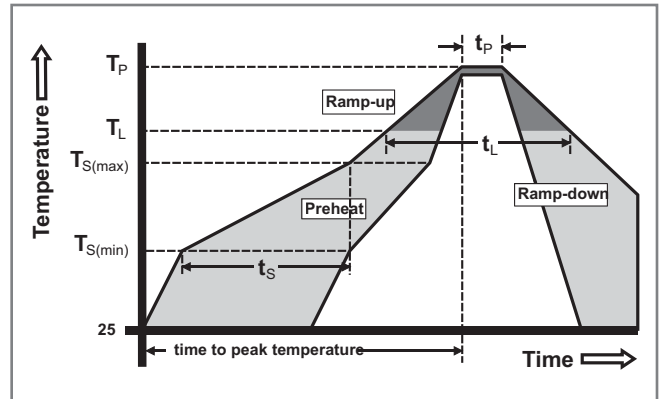

Physical Specifications

Terminal Finish	100% Matte Tin-plated
Body Material	UL recognized epoxy meeting flammability classification 94V-0
Terminal Material	Copper Alloy

Design Considerations

Careful selection of the correct device for the application's operating parameters and environment will go a long way toward extending the operating life of the Thyristor. Good design practice should limit the maximum continuous current through the main terminals to 75% of the device rating. Other ways to ensure long life for a power discrete semiconductor are proper heat sinking and selection of voltage ratings for worst case conditions. Overheating, overvoltage (including dv/dt), and surge currents are the main killers of semiconductors. Correct mounting, soldering, and forming of the leads also help protect against component damage.

Environmental Specifications

Test	Specifications and Conditions
AC Blocking (V_{DRM})	MIL-STD-750, M-1040, Cond A Applied Peak AC voltage @ 110°C for 1008 hours
Temperature Cycling	MIL-STD-750, M-1051, 100 cycles; -40°C to +150°C; 15-min dwell-time
Temperature/Humidity	EIA / JEDEC, JESD22-A101 1008 hours; 320V - DC: 85°C; 85% rel humidity
High Temp Storage	MIL-STD-750, M-1031, 1008 hours; 150°C
Low-Temp Storage	1008 hours; -40°C
Autoclave	EIA / JEDEC, JESD22-A102 168 hours (121°C at 2 ATMs) and 100% R/H
Resistance to Solder Heat	MIL-STD-750 Method 2031
Solderability	ANSI/J-STD-002, category 3, Test A
Lead Bend	MIL-STD-750, M-2036 Cond E

Dimensions — TO-220AB (R-Package) — Non-Isolated Mounting Tab Common with Center Lead

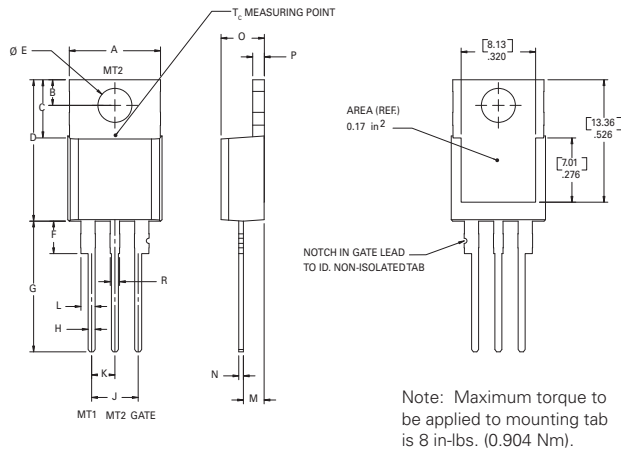

Dimension	Inches		Millimeters	
	Min	Max	Min	Max
A	0.380	0.420	9.65	10.67
B	0.105	0.115	2.67	2.92
C	0.230	0.250	5.84	6.35
D	0.590	0.620	14.99	15.75
E	0.142	0.147	3.61	3.73
F	0.110	0.130	2.79	3.30
G	0.540	0.575	13.72	14.61
H	0.025	0.035	0.64	0.89
J	0.195	0.205	4.95	5.21
K	0.095	0.105	2.41	2.67
L	0.060	0.075	1.52	1.91
M	0.085	0.095	2.16	2.41
N	0.018	0.024	0.46	0.61
O	0.178	0.188	4.52	4.78
P	0.045	0.060	1.14	1.52
R	0.038	0.048	0.965	1.22

Dimensions — TO-220AB (L-Package) — Isolated Mounting Tab

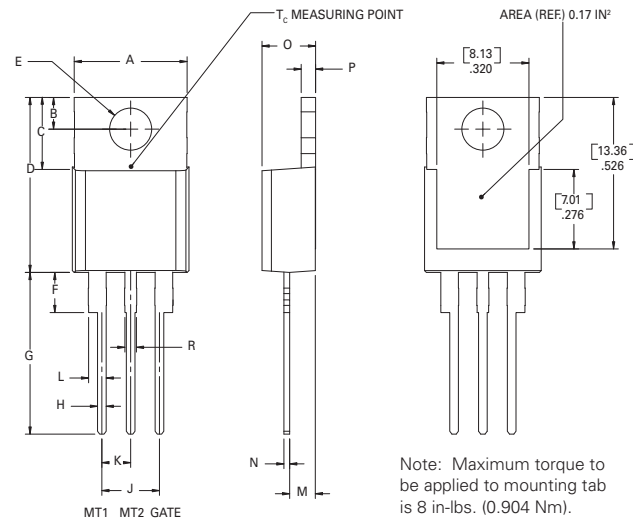

Dimension	Inches		Millimeters	
	Min	Max	Min	Max
A	0.380	0.420	9.65	10.67
B	0.105	0.115	2.67	2.92
C	0.230	0.250	5.84	6.35
D	0.590	0.620	14.99	15.75
E	0.142	0.147	3.61	3.73
F	0.110	0.130	2.79	3.30
G	0.540	0.575	13.72	14.61
H	0.025	0.035	0.64	0.89
J	0.195	0.205	4.95	5.21
K	0.095	0.105	2.41	2.67
L	0.060	0.075	1.52	1.91
M	0.085	0.095	2.16	2.41
N	0.018	0.024	0.46	0.61
O	0.178	0.188	4.52	4.78
P	0.045	0.060	1.14	1.52
R	0.038	0.048	0.97	1.22

Dimensions — TO-263AB (N-Package) — D²-PAK Surface Mount

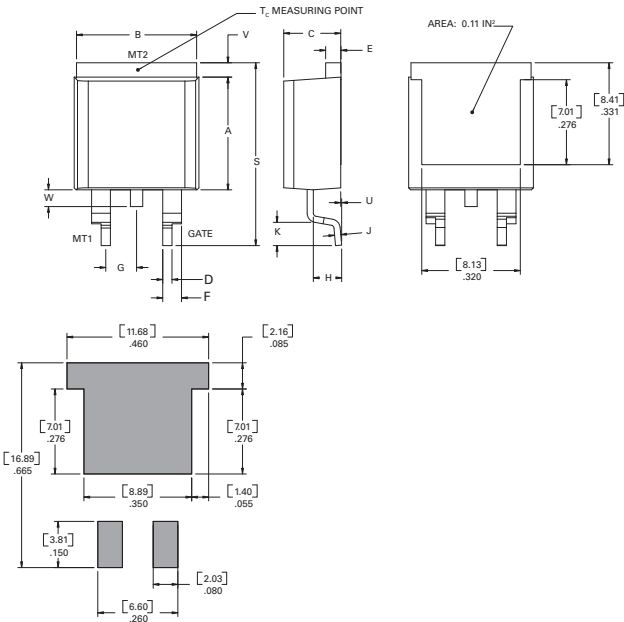

Dimension	Inches		Millimeters	
	Min	Max	Min	Max
A	0.360	0.370	9.14	9.40
B	0.380	0.420	9.65	10.67
C	0.178	0.188	4.52	4.78
D	0.025	0.035	0.64	0.89
E	0.045	0.060	1.14	1.52
F	0.060	0.075	1.52	1.91
G	0.095	0.105	2.41	2.67
H	0.092	0.102	2.34	2.59
J	0.018	0.024	0.46	0.61
K	0.090	0.110	2.29	2.79
S	0.590	0.625	14.99	15.88
V	0.035	0.045	0.89	1.14
U	0.002	0.010	0.05	0.25
W	0.040	0.070	1.016	1.78

Product Selector

Part Number	Gate Sensitivity Quadrants	Type	Package
	I – II – III		
Q6008LH1LED	10 mA	Alternistor Triac	TO-220L
Q6008RH1LED	10 mA	Alternistor Triac	TO-220R
Q6008NH1LED	10 mA	Alternistor Triac	TO-263 D ² -PAK

Packing Options

Part Number	Marking	Weight	Packing Mode	Base Quantity
Q6008LH1LED	Q6008LH1	2.2 g	Bulk	500
Q6008LH1LEDTP	Q6008LH1	2.2 g	Tube Pack	500 (50 per tube)
Q6008RH1LED	Q6008RH1	2.2 g	Bulk	500
Q6008RH1LEDTP	Q6008RH1	2.2 g	Tube Pack	500 (50 per tube)
Q6008NH1LED	Q6008NH1	1.6g	Tube	500 (50 per tube)
Q6008NH1LED	Q6008NH1	1.6g	Embossed Carrier	500 (50 per tube)

TO-263 Embossed Carrier Reel Pack (RP) Specifications

Meets all EIA-481-2 Standards

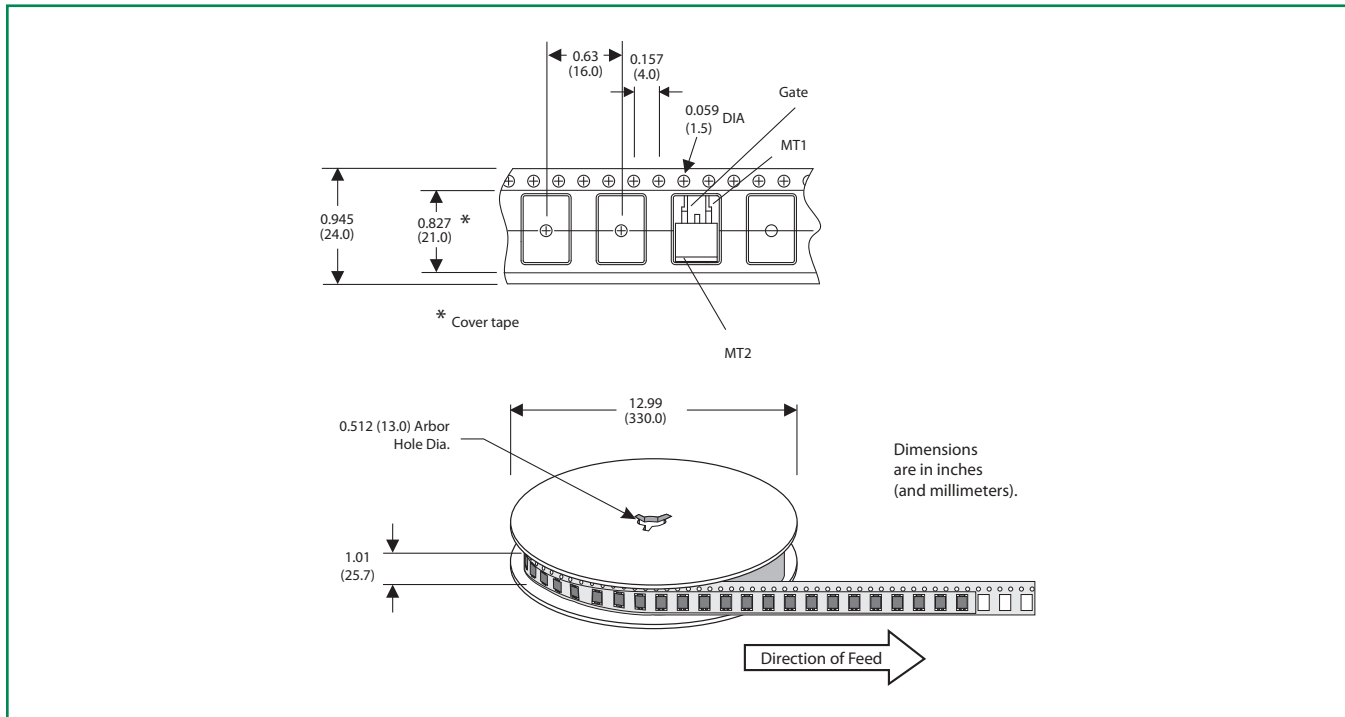

Part Numbering System

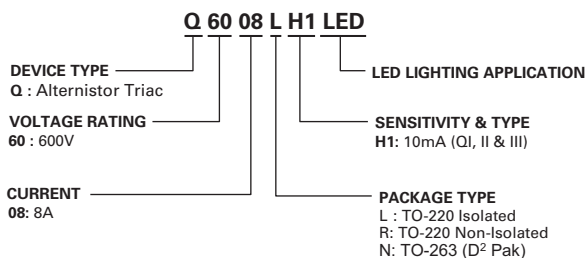

Part Marking System

TO-220 AB - (L and R Package)
TO-263 AB - (N Package)

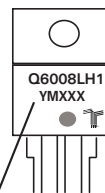

Date Code Marking
Y: Year Code
M: Month Code
XXX: Lot Trace Code

Looking for pricing, stock, or lifecycle information?

Click below to explore more details on WIN SOURCE:

 [View Q6008NH1LEDRP on WIN SOURCE](#)

 [Littelfuse Inc. Information](#)

Optimize Your Supply Chain with WIN SOURCE Solutions

-  Global Sourcing Solution
-  Obsolete Management
-  Cost Control Management
-  Shortage Management
-  Alternative Solution
-  Excess Inventory Management