



THE DATASHEET OF PYC-P



Power-switching Compact General-purpose Relays



- Wiring work can be shortened by as much as 60%* compared to conventional screw terminal sockets by combining with push-in plus terminal sockets (PYF-□-PU) that feature light insertion force and strong pull-out strength to achieve less wiring work.
- The standard models include models that are compliant with the UL, CSA, and SEV safety standards and with the Electrical Appliances and Material Safety Act.
- Equipped with an arc barrier for arc interruption.
- Withstand voltages up to 2,000 V.
- New built-in diode and built-in CR circuit models have joined the series.
- The lineup also includes models that are compliant with the LR and VDE safety standards.
- When both push-in plus terminals and screw terminal sockets are combined with plug-in terminal types (according to actual OMRON measurements as of November 2015)

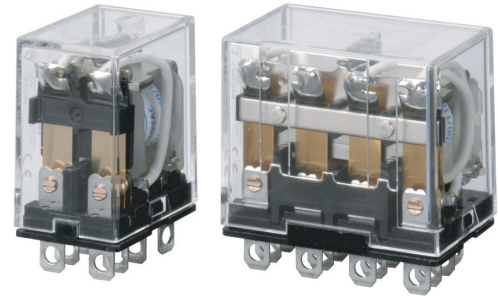

Refer to the standards certifications and compliance section of your OMRON website for the latest information on certified models.

Refer to the *Common Relay Precautions*.

Model Number Structure

Classification	Structure	Relays with Plug-in Terminals		Relays with PCB Terminals	Case-surface mounting
			With operation indicators		
Standard models Compliance with Electrical Appliances and Material Safety Act	1	*LY1	**LY1N	*LY1-0	*LY1F
	2	*LY2	**LY2N	*LY2-0	*LY2F
		Bifurcated	**LY2Z	**LY2ZN	**LY2Z-0
	3	---	---	*LY3-0	---
Models with diode for coil surge absorption (DC coil specification only) 	1	**LY1-D	**LY1N-D2	---	---
	2	*LY2-D	*LY2N-D2	---	---
		Bifurcated	**LY2Z-D	**LY2ZN-D2	---
Models with CR circuits for coil surge absorption (AC coil specification only) 	1	—	—	/	/
	2	*LY2-CR	*LY2N-CR		
		Bifurcated	**LY2Z-CR		

- Note:**
1. Cells with a diagonal line cannot be manufactured. Ask your OMRON representative for details on manufacturing products for cells containing "—" in the above table.
 2. If #187 tab terminals are required, use the LY1F-T2 or LY2F-T2 (single-pole or double-pole models only).
 3. Refer to page 20 for information on plug-in terminal and socket combinations.
 4. Items with an asterisk (*) in the table are certified for UL, CSA, and SEV. This is indicated with a certification mark on the products.
 5. Items with two asterisks (**) in the table are certified for UL and CSA. This is indicated with a certification mark on the products.
 6. All models in the table are certified for IEC (TÜV).
 7. The models with plug-in terminals (single-pole, double-pole, and 4-pole) were combined with the PTF-E for the EC Declaration of Conformity. These products display the CE Marking.

Ordering Information

When your order, specify the rated voltage.

Relays

Models with Plug-in Terminals

Classification		1 pole		2 poles		4 poles	
		Model	Rated voltage (V)	Model	Rated voltage (V)	Model	Rated voltage (V)
Models with single contacts	Standard models	LY1	12, 24, 100/110, 110/120, or 200/220 VAC	LY2	12, 24, 100/110, 110/120, 200/220, or 220/240 VAC	LY4	12, 24, 100/110, or 200/220 VAC
			12, 24, 48, or 100/110 VDC		12, 24, 48, or 100/110 VDC		12, 24, 48, or 100/110 VDC
	Models with built-in operation indicators	LY1N	12, 24, 100/110, 110/120, or 200/220 VAC	LY2N	12, 24, 100/110, 110/120, 200/220, or 220/240 VAC	LY4N	12, 24, 100/110, or 200/220 VAC
			12, 24, or 100/110 VDC		12, 24, 48, or 100/110 VDC		12, 24, 48, or 100/110 VDC
	Models with built-in diodes	LY1-D	12, 24, 48, or 100/110 VDC	LY2-D	12, 24, 48, or 100/110 VDC	LY4-D	12, 24, 48, or 100/110 VDC
	Models with built-in diodes and operation indicators	LY1N-D2	12, 24, or 48 VDC	LY2N-D2	12, 24, 48, or 100/110 VDC	LY4N-D2	12, 24, 48, or 100/110 VDC
Models with built-in CR circuits	---	---	LY2-CR	100/110, 110/120, 200/220, or 220/240 VAC	---	---	
Models with built-in CR circuits and operation indicators	---	---	LY2N-CR	100/110, 110/120, 200/220, or 220/240 VAC	---	---	
Bifurcated contacts	Standard models	---	---	LY2Z	100/110 or 200/220 VAC	---	---
		---	---		12, 24, 48, or 100/110 VDC	---	---
	Models with built-in operation indicators	---	---	LY2ZN	100/110, 110/120, 200/220, or 220/240 VAC	---	---
		---	---		12 or 24 VDC	---	---
	Models with built-in diodes	---	---	LY2Z-D	12, 24, or 48 VDC	---	---
	Models with built-in diodes and operation indicators	---	---	LY2ZN-D2	12, 24, or 100/110 VDC	---	---
	Models with built-in CR circuits	---	---	LY2Z-CR	100/110 VAC	---	---
Models with built-in CR circuits and operation indicators	---	---	LY2ZN-CR	100, 110, 110/120, or 200/220 VAC	---	---	

Relays with PCB Terminals

Classification		1 pole		2 poles		3 poles		4 poles	
		Model	Rated voltage (V)	Model	Rated voltage (V)	Model	Rated voltage (V)	Model	Rated voltage (V)
Models with single contacts	LY1-0	24, 100/110, 110/120, or 200/220 VAC	LY2-0	12, 24, 100/110, 110/120, 200/220, or 220/240 VAC	LY3-0	24, 100/110, or 200/220 VAC	LY4-0	24, 100/110, or 200/220 VAC	
		12 or 24 VDC		12, 24, 48, or 100/110 VDC		12, 24, 48, or 100/110 VDC			
Bifurcated contacts	---	---	LY2Z-0	100/110 VAC 24, 48, or 100/110 VDC	---	---	---	---	

Case-surface Mounting

Classification		1 pole		2 poles		4 poles	
		Model	Rated voltage (V)	Model	Rated voltage (V)	Model	Rated voltage (V)
Models with single contacts	LY1F	24, 100/110, 110/120, 200/220, or 220/240 VAC	LY2F	12, 24, 100/110, 110/120, 200/220, or 220/240 VAC	LY4F	12, 24, 100/110, or 200/220 VAC	
		6, 12, 24, or 100/110 VDC		12, 24, 48, or 100/110 VDC		12, 24, or 100/110 VDC	
Bifurcated contacts	---	---	LY2ZF	24, 100/110, or 200/220 VAC 12 or 24 VDC	---	---	



Accessories (Order Separately)

Front-mounting Sockets

Applicable relay model	Mounting Method	Conductive part protection	Terminal Type	Applicable crimp terminal/ Electric wire	Appearance	Model	Hold-down Clips/ Release Levers (Order Separately)
LY1□ LY2□ LY2□-CR	Mounted on a DIN track or with screws	Available	Push-In Plus Terminal	Ferrules Solid wire Stranded wire		PTF-08-PU * LY2□-CR cannot be used	With release lever * Hold by release lever
						PTF-08-PU-L	
			Screw terminal (M3.5 screw size)	Forked terminals Solid wire Stranded wire		PTFZ-08-E *	LY2□-CR: Y92H-3 Other than those above: PTC-A1
						PTF08A-E *	
		None	Round terminals Forked terminals Solid wire Stranded wire		PTF08A		
		LY4□	Available	Push-In Plus Terminal	Ferrules Solid wire Stranded wire		
	PTFZ-14-E *						
Screw terminal (M3.5 screw size)	Forked terminals Solid wire Stranded wire				PTF14A-E *		
				None	Round terminals Forked terminals Solid wire Stranded wire		PTF14A

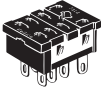
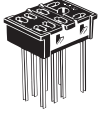
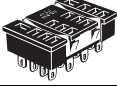
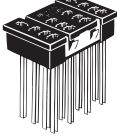

* The PYFZ□A-E and PTF□A-E Relays have finger protection. Round terminals cannot be used. Use forked terminals.

Back-mounting Sockets

Applicable relay model	Terminal Type	Appearance	Mode	Hold-down Clips (Order Separately)
LY1□ LY2□ LY2□-CR	Solder terminals		PT08*	LY2□-CR: PYC-1 Other than those above: PYC-P
	Wrapping terminals		PT08QN	
	PCB terminals		PT08-0	
LY4□	Solder terminals		PT14*	PYC-P
	Wrapping terminals		PT14QN	
	PCB terminals		PT14-0	

* When ordering PT08, PT11, or PT14 sockets, please note that the minimum order quantity is 10 and orders are accepted in multiples of the minimum order.

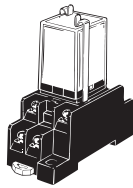
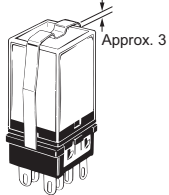
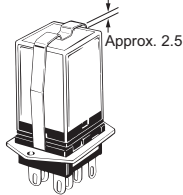
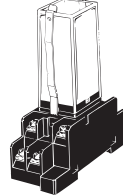
Relay Hold-down Clips

Application Item	Used with Socket		Used with Socket mounting plate	For models with built-in CR circuits	
Appearance					
Model	PYC-A1	PYC-P	PYC-S	Y92H-3	PYC-1
Minimum order (quantity)*	100	100	10	10	10

* Orders are accepted in multiples of the minimum order.



Socket Mounting Plates

Applicable sockets	Number of sockets	Model
PT08 PT08QN	1	PYP-1 *1
	18	PYP-18 *2
	36	PYP-36 *2
PT14 PT14QN	1	PTP-1
	10	PTP-10

*1. When ordering PYP-1, please note that the minimum order quantity is 10 and orders are accepted in multiples of the minimum order.

*2. PYP-18 and PYP-36 can be cut to any required length.

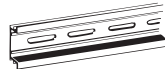
DIN Track Mounting Parts

Type		Appearance	Model
DIN Tracks	Shallow type, total length: 1 m		PFP-100N
	Shallow type, total length: 0.5 m		PFP-50N
	Deep type, total length: 1 m		PFP-100N2
End Plate			PFP-M
Spacer			PFP-S

Ratings and Specifications

Ratings

Standard Models with Built-in Operation Indicators

Operating Coil, Single-pole and Double-pole Models

Item	Rated voltage (V)	Rated current (mA)		Coil resistance (Ω)	Coil inductance (H)		Must-operate voltage (V)	Must-release voltage (V)	Maximum voltage (V)	Power consumption (VA, W)
		50 Hz	60Hz		Armature OFF	Armature ON				
AC	12	106.5	91	46	0.17	0.33	80% max.*1	30% min.*2	110% of rated voltage	Approx. 1.0 to 1.2 (at 60 Hz)
	24	53.8	46	180	0.69	1.3				
	50	25.7	22	788	3.22	5.66				
	100/110	11.7/12.9	10/11	3,750	14.54	24.6				Approx. 0.9 to 1.1 (at 60 Hz)
	110/120	9.9/10.8	8.4/9.2	4,430	19.2	32.1				
	200/220	6.2/6.8	5.3/5.8	12,950	54.75	94.07				
	220/240	4.8/5.3	4.2/4.6	18,790	83.5	136.4				
DC	6	150		40	0.16	0.33	80% max.*1	10% min.*2	110% of rated voltage	Approx. 0.9
	12	75		160	0.73	1.37				
	24	36.9		650	3.2	5.72				
	48	18.5		2,600	10.6	21.0				
	100/110	9.1/10		11,000	45.6	86.2				

3 poles

Item	Rated voltage (V)	Rated current (mA)		Coil resistance (Ω)	Coil inductance (H)		Must-operate voltage (V)	Must-release voltage (V)	Maximum voltage (V)	Power consumption (VA, W)
		50 Hz	60Hz		Armature OFF	Armature ON				
AC	12	159	134	24	0.12	0.21	80% max.*1	30% min.*2	110% of rated voltage	Approx. 1.6 to 2.0 (at 60 Hz)
	24	80	67	100	0.44	0.79				
	100/110	14.1/16	12.4/13.7	2,300	10.5	18.5				
	200/220	9.0/10.0	7.7/8.5	8,650	34.8	59.5				
DC	12	112		107	0.45	0.98	80% max.*1	10% min.*2	110% of rated voltage	Approx. 1.4
	24	58.6		410	1.89	3.87				
	48	28.2		1,700	8.53	13.9				
	100/110	12.7/13		8,500	29.6	54.3				

4 poles

Item	Rated voltage (V)	Rated current (mA)		Coil resistance (Ω)	Coil inductance (H)		Must-operate voltage (V)	Must-release voltage (V)	Maximum voltage (V)	Power consumption (VA, W)
		50 Hz	60Hz		Armature OFF	Armature ON				
AC	12	199	170	20	0.1	0.17	80% max.*1	30% min.*2	110% of rated voltage	Approx. 1.95 to 2.5 (at 60 Hz)
	24	93.6	80	78	0.38	0.67				
	100/110	22.5/25.5	19/21.8	1,800	10.5	17.3				
	200/220	11.5/13.1	9.8/11.2	6,700	33.1	57.9				
DC	12	120		100	0.39	0.84	80% max.*1	10% min.*2	110% of rated voltage	Approx. 1.5
	24	69		350	1.41	2.91				
	48	30		1,600	6.39	13.6				
	100/110	15/15.9		6,900	32.0	63.7				

Note: 1. The rated current and coil resistance are measured at a coil temperature of 23°C with tolerances of +15%/–20% for the AC rated current and ±15% for the DC coil resistance.

2. The AC coil resistance and inductance values are reference values only. (at 60 Hz).

3. Operating characteristics were measured at a coil temperature of 23°C.

4. The maximum voltage capacity was measured at an ambient temperature of 23°C.

*1. There is variation between products, but actual values are 80% max.

To ensure operation, apply at least 80% of the rated value (at a coil temperature of +23° C).

*2. The actual values are 30% min. for AC and 10% min. for DC. To ensure release, use a value that is lower than the specified value.

Refer to *List of Certified Models* for a list of models that are certified for safety standards and the Electrical Appliances and Material Safety Act.

Item	Classification	1 pole		Double-, 3-, and 4-pole models		Bifurcated contacts	
		Resistive load	Inductive load (cos φ = 0.4, L/R = 7 ms)	Resistive load	Inductive load (cos φ = 0.4, L/R = 7 ms)	Resistive load	Inductive load (cos φ = 0.4, L/R = 7 ms)
Contact type		Single				Bifurcated	
Contact materials		Ag alloy					
Rated load		15 A at 110 VAC 15 A at 24 VDC	10 A at 110 VAC 7 A at 24 VDC	10 A at 110 VAC 10 A at 24 VDC	7.5 A at 110 VAC 5 A at 24 VDC	5 A at 110 VAC 5 A at 24 VDC	4 A at 110 VAC 4 A at 24 VDC
Rated carry current		15 A		10 A		7 A	
Maximum contact voltage		250 VAC 125 VDC		250 VAC 125 VDC		250 VAC 125 VDC	
Maximum contact current		15 A	15 A	10 A	10 A	7 A	7 A

Item	Type	Single-pole and double-pole models (standard models and bifurcated contact models)	Single-pole, double-pole models (models with built-in operation indicators, models with built-in diodes, and models with built-in CR circuits), 3-pole and 4-pole models
Ambient operating temperature		-25 to 55°C (with no icing or condensation)*1	-25 to +40°C (with no icing or condensation)*2
Ambient operating humidity		5% to 85%	

- Note:**
- Some models in the LY1 and LY2 Series have an upper temperature limit of +40°C. This limitation is due to the diode junction temperature and the elements used. Refer to *Ambient Temperature vs. Coil Temperature Rise* in *Engineering Data* on page 8 to 9 for information on operation in temperature conditions that are not described here.
 - When you apply a minimum of 10 A of current to an LY1 when it is used in combination with the PTF-08-PU, PTF-08-PU-L, PTF08A, PTF08A-E, or PT08, connect each of the following terminal pairs: (1) to (2), (3) to (4), and (5) to (6).
 - If the carry current is 4 A or less, the usable ambient temperature range is -25 to 70° C.
 - If the flowing current is 4 A or less, the usable ambient temperature range is -25 to 55° C.

Characteristics

Item	Type	Standard models, models with built-in operation indicators, models with built-in CR circuits, and models with built-in diodes	Bifurcated contacts
Contact resistance*1		50 mΩ max.	
Operating time*2		25 ms max.	
Release time*2		25 ms max.	
Maximum operating frequency	Mechanical	18,000 operations/h	
	Rated load	1,800 operations/h	
Insulation resistance*3		100 MΩ min.	
Dielectric strength	Between coil and contacts	2,000 VAC at 50/60 Hz for 1 min.	
	Between contacts of different polarity	2,000 VAC at 50/60 Hz for 1 min.	
	Between contacts of the same polarity	1,000 VAC at 50/60 Hz for 1 min.	
Vibration resistance	Destruction	10 to 55 to 10 Hz, 0.5-mm single amplitude (1.0-mm double amplitude)	
	Malfunction	10 to 55 to 10 Hz, 0.5-mm single amplitude (1.0-mm double amplitude)	
Shock resistance	Destruction	1,000 m/s ²	
	Malfunction	200 m/s ²	
Endurance	Mechanical	AC: 50,000,000 operations min. DC: 100,000,000 operations min.	(switching frequency: 18,000 operations/h)
	Electrical*4	1-, 3-, 4-pole: 200,000 operations min. 2-pole: 500,000 operations min. (rated load, operating frequency: 1,800 operations/h)	2-pole: 500,000 operations min. (rated load, operating frequency: 1,800 operations/h)
Failure rate P value (reference value)*5		100 mA at 5 VDC	10mA at 5 VDC
Weight		1-pole and 2-pole: 40 g, 3-pole: Approx. 50 g, 4-pole: Approx. 70 g	

- Note:** The values at the left are initial values.
- *1. Measurement conditions: 1 A at 5 VDC using the voltage drop method
 - *2. Measurement conditions: With rated operating power applied, not including contact bounce. Ambient temperature condition: 23° C
 - *3. Measurement conditions: For 500 VDC applied to the same location as for dielectric strength measurement.
 - *4. Ambient temperature condition: 23° C
 - *5. This value was measured at a switching frequency of 120 operations per minute.

Endurance Under Real Loads (Reference Only)

Item	Load type	LY1, 100 VAC			LY2, 100 VAC			LY4, 100 VAC		
		Conditions	Operating frequency	Electrical life (×10,000 operations min.)	Conditions	Operating frequency	Electrical life (×10,000 operations min.)	Conditions	Operating frequency	Electrical life (×10,000 operations min.)
AC motor	400 W, 100 VAC single-phase with 35-A inrush current, 7-A current flow	ON for 10 s, OFF for 50 s	5	200 W, 100 VAC single-phase with 25-A inrush current, 5-A current flow	ON for 10 s, OFF for 50 s	20	200 W, 200 VAC three-phase with 5-A inrush current, 1-A current flow	ON for 10 s, OFF for 50 s	50	
							750 W, 200 VAC three-phase with 18-A inrush current, 3.5-A current flow			7
AC lamp	300 W, 100 VAC with 51-A inrush current, 3-A current flow	ON for 5 s, OFF for 55 s	10	300 W, 100 VAC with 51-A inrush current, 3-A current flow	ON for 5 s, OFF for 55 s	8	300 W, 100 VAC with 51-A inrush current, 3-A current flow	ON for 5 s, OFF for 55 s	5	
	500 W, 100 VAC with 78-A inrush current, 5-A current flow		2.5							
Capacitor (2,000 μF)	24 VDC with 50-A inrush current, 1-A current flow	ON for 1 s, OFF for 6 s	10	24 VDC with 50-A inrush current, 1-A current flow	ON for 1 s, OFF for 15 s	1	24 VDC with 50-A inrush current, 1-A current flow	ON for 1 s, OFF for 15 s	0.5	
				24 VDC with 20-A inrush current, 1-A current flow			15			24 VDC with 20-A inrush current, 1-A current flow
AC solenoid	50 VA with 2.5-A inrush current, 0.25-A current flow	ON for 1 s, OFF for 2 s	150	50 VA with 2.5-A inrush current, 0.25-A current flow	ON for 1 s, OFF for 2 s	100	50 VA with 2.5-A inrush current, 0.25-A current flow	ON for 1 s, OFF for 2 s	100	
	100 VA with 5-A inrush current, 0.5-A current flow		80	100 VA with 5-A inrush current, 0.5-A current flow			50			100 VA with 5-A inrush current, 0.5-A current flow

Details on Safety-standard-certified Models, LY□

- Standard models are certified for the UL, CSA, and SEV safety standards.
- Refer to *Model Number Structure* on page 1 for a list of applicable models.
- The rated values for safety standard certification are not the same as individually defined performance values. Always check the specifications before use.

UL-certified Models (File No. E41643)

Model	Coil ratings	Number of poles	Contact ratings	Certified number of operations	
LY	6 to 240VAC 6 to 125VDC	1	15A, 120VAC (General use)	100,000 operations	
			15A, 240VAC (General use)	6,000 operations	
			15A, 30VDC (Resistive)		
			1/2HP, 120VAC	100,000 operations	
			8.5FLA, 30LRA, 120VAC	25,000 operations	
			TV-5, 120VAC		
			470VA, Pilot duty, 120VAC		6,000 operations
	6 to 240VAC 6 to 125VDC	2	15A, 120VAC (General use)	100,000 operations	
			12A, 240VAC (General use)	6,000 operations	
			7A, 250VAC (General use)		
			15A, 30VDC (Resistive)		
			5A, 38VDC (Resistive)		
			1/2HP, 120VAC	100,000 operations	
			1/3HP, 240VAC	1,000 operations	
			8.5FLA, 30LRA, 120VAC	100,000 operations	
			5FLA, 50LRA, 50VDC	25,000 operations	
			TV-3, 120VAC		
			345VA, Pilot duty, 120-240VAC		6,000 operations
			B300/R300	6,000 operations	
	6 to 240VAC 6 to 125VDC	3 4	10A, 240VAC (General use) (Same polarity)	6,000 operations	
			10A, 30VDC (General use) (Same polarity)		
			2A, 40VDC (Resistive) (Same polarity)	1,000 operations	
			1/2HP, 240VAC		
			0.6A, 100VDC (Resistive) (Same polarity)		6,000 operations

CSA-certified Models (File No. LR31928)

Model	Coil ratings	Number of poles	Contact ratings	Certified number of operations
LY	6 to 240VAC 6 to 125VDC	1	15A, 120VAC (General use)	100,000 operations
			15A, 240VAC (General use)	6,000 operations
			15A, 30VDC (Resistive)	
			1/2HP, 120VAC	100,000 operations
			8.5FLA, 30LRA, 120VAC	25,000 operations
			TV-5, 120VAC	
			470VA, Pilot duty, 120VAC	
	6 to 240VAC 6 to 125VDC	2	15A, 120VAC (General use)	6,000 operations
			12A, 240VAC (General use)	
			7A, 250VAC (General use)	
			15A, 30VDC (Resistive)	
			5A, 38VDC (Resistive)	100,000 operations
			1/2HP, 120VAC	
			1/3HP, 240VAC	1,000 operations
			8.5FLA, 30LRA, 120VAC	100,000 operations
			5FLA, 50LRA, 50VDC	25,000 operations
			TV-3, 120VAC	
			345VA, Pilot duty, 120-240VAC	
			B300/R300 Pilot duty	6,000 operations
	6 to 240VAC 6 to 125VDC	3 4	10A, 240VAC (General use) (Same polarity)	6,000 operations
			10A, 30VDC (Resistive) (Same polarity)	
			1/8HP, 240VAC (Same polarity)	1,000 operations
			1/2HP, 240VAC (Same polarity)	
			1/3HP, 240VAC (Same polarity)	
			2A, 40VDC (Resistive)	6,000 operations
	0.6A, 100VDC (Resistive)			

TÜV-certified Models (File No. R50030064, EN 61810-1)

Model	Coil ratings	Number of poles	Contact ratings	Certified number of operations	
LY□	6 to 240 VAC 6 to 110 VDC	1	15 A, 110 VDC resistive load	200,000 operations	
			10 A, 110 VAC inductive load		
			10 A, 250 VAC resistive load		
			7A, 250 VAC inductive load		
			10 A, 30 VDC resistive load		
			7 A, 30 VDC inductive load		
		2	10 A, 110 VAC resistive load		100,000 operations
			7.5A, 110 VAC inductive load		
			7A, 250 VAC resistive load		
			4 A, 250 VAC inductive load		
			7 A, 30 VDC resistive load		
			4 A, 30 VDC inductive load		
		3 4	10 A, 110 VAC resistive load		100,000 operations
			7.5A, 110 VAC inductive load		

- When ordering a model that is certified for VDE or Lloyd's Register (LR) standards, always specify "VDE-certified Model" or "LR Standard-certified Model" with your order.

VDE Certification (Certificate No. 6359, EN 61810-1)

Model	Coil ratings	Number of poles	Contact ratings	Certified number of operations
LY□-VD	6, 12, 24, 50, 110, or 220 VAC 6, 12, 24, 48, or 110 VDC	1	10 A, 220 VAC resistive load	200,000 operations
			7 A, 220 VAC inductive load	
			10 A, 28 VDC resistive load	
			7 A, 28 VDC inductive load	
		2	7 A, 220 VAC resistive load	
			4 A, 220 VAC inductive load	
			7 A, 28 VDC resistive load	
			4 A, 28 VDC inductive load	

LR-certified Models (File No. 00/10047)

Model	Coil ratings	Number of poles	Contact ratings
LY□	6 to 240 VAC 6 to 110 VDC	2	7.5 A, 230 VAC inductive load
		4	5 A, 24 VDC inductive load

Details on Safety-standard-certified Models, Sockets

UL-certified Models (File No. E87929) 

Model	Ratings	Listed/Recognized
PTF-08-PU	10A 250V	Recognized
PTF-14-PU	10A 250V (Same polarity)	
PTFZ-08-E	15A 250V (at 50 deg)	
PTFZ-14-E	12A 250V (at 70 deg)	
PTF08A(-E) PT08	15A 250V	
PTF11A PTF14A(-E) PT11 PT14	10A 250V	

CSA-certified Models (File No. LR31928) 

Model	Ratings	Class number
PTF-08-PU	10A 250V	3211 07
PTF-14-PU	10A 250V (Same polarity)	
PTFZ-08-E	15A 250V (at 50 deg)	
PTFZ-14-E	12A 250V (at 70 deg)	
PTF08A(-E)	15A 240V AC	
PTF11A PTF14A(-E)	10A 240V AC	

CE Marking Compliance

Model	EMC Directive	Low Voltage Directive	Machinery Directive	Safety Category
PTFZ-08-E	Not applicable	○	Not applicable	1
PTFZ-14-E				
PTF08A(-E)				
PTF14A(-E)				

- Note:**
- CE compliance is achieved when used with a relay (LY).
 - The Safety Category refers to the maximum applicable category selected when constructing control system safety components. The category does not apply to individual components.

TÜV Rheinland certification

Model	Ratings	Standard number	Certification number
PTF-08-PU	10A 250V *1	EN 61984	R50327595
PTF-14-PU	10A 250V *2		
PTFZ-08-E	15A 250V (at 50 deg)		R50438680
PTFZ-14-E	12A 250V (at 70 deg)		

- *1. Ratings are for an ambient temperature of 55°C. At an ambient temperature of 70°C, the value is 7A.
*2. Ratings are for an ambient temperature of 40°C. At an ambient temperature of 70°C, the value is 7A.

Compliance with Electrical Appliances and Material Safety Act, LY□

All standard models comply with the Electrical Appliances and Material Safety Act.

Model	Coil ratings	Number of poles	Contact ratings
LY□	6 to 240 VAC 6 to 120 VDC	1	15 A at 200 VAC
		2	10A at 200 VAC
		3	
		4	

Engineering Data

Engineering Data

Maximum Switching Capacity LY1



LY2



LY3 and LY4

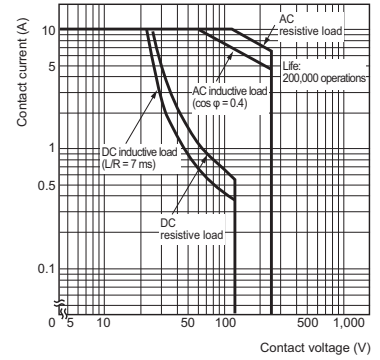

LY2Z

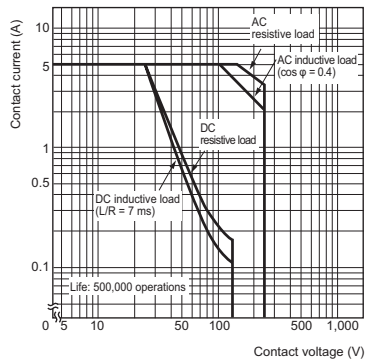

Endurance Curve

LY1

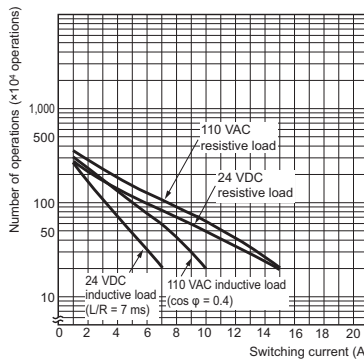

LY2

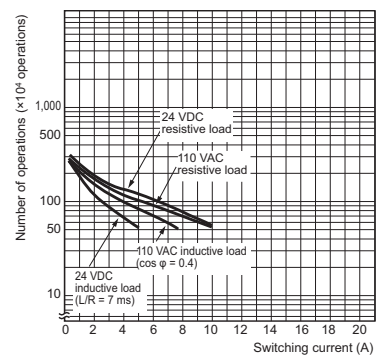

LY3 and LY4

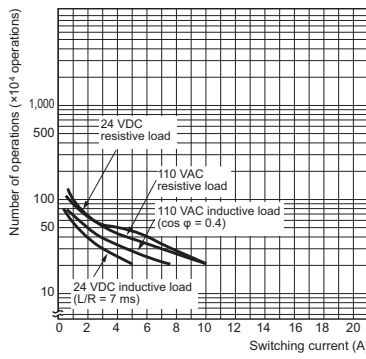

LY2Z

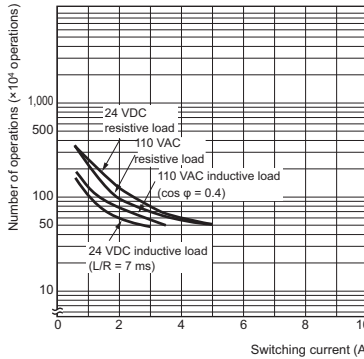

Ambient Temperature vs. Must-operate and Must-release Voltage LY2 100/110 VAC at 50Hz

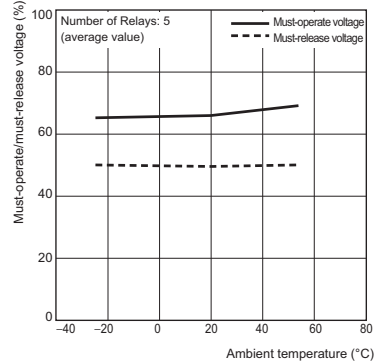

Ambient Temperature vs. Coil Temperature Rise

LY2 24 VDC

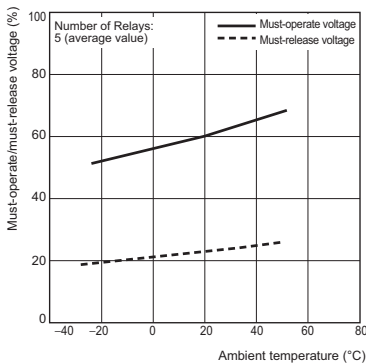

LY1 24 VDC

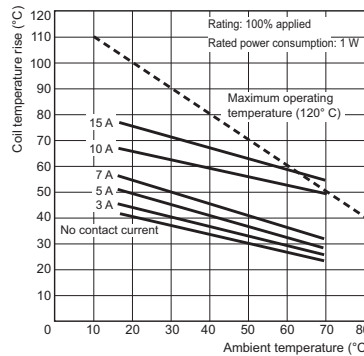

LY1 100/110 VAC at 50Hz

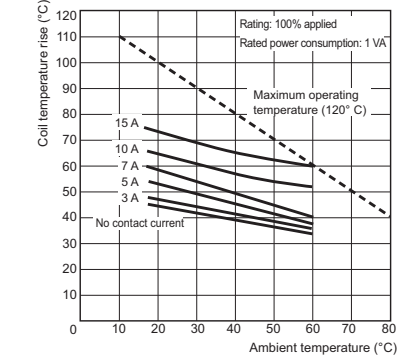

LY2 24 VDC

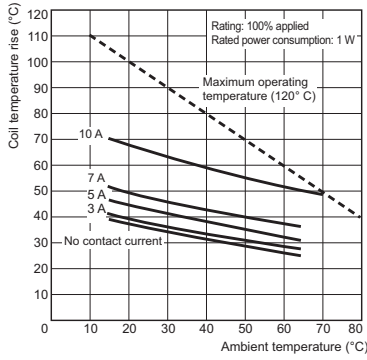

LY2 100/110 VAC at 50Hz

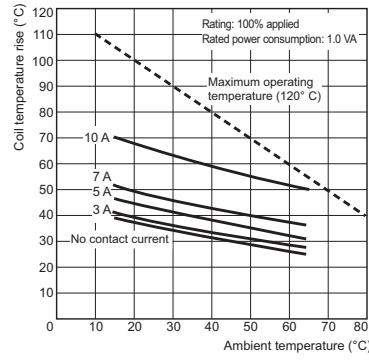

LY3 24 VDC

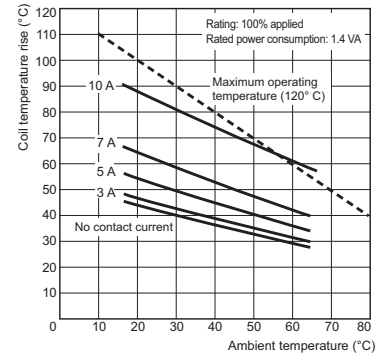

LY3 100/110 VAC at 50Hz

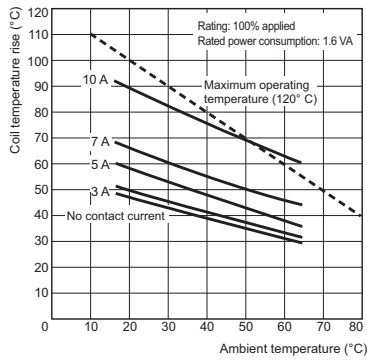

LY4 24 VDC

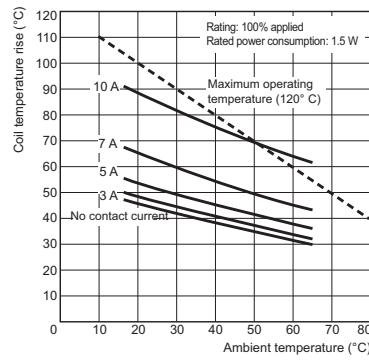

LY4 100/110 VAC at 50Hz

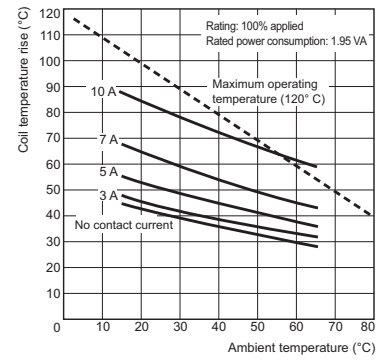

Models with built-in diodes

The diode absorbs surge from the coil.

With Diode

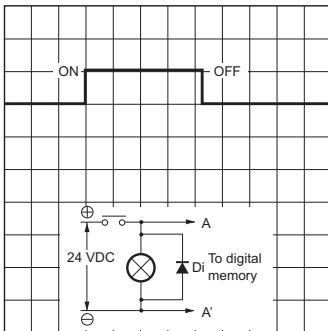

Without Diode

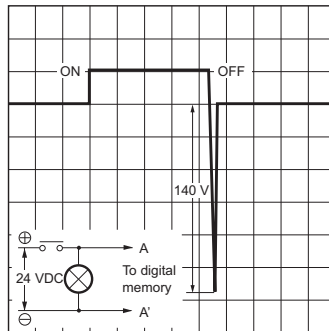

- Note:**
1. Make sure that the polarity is correct.
 2. The release time will increase, but the 25-ms specification for standard models is satisfied.
 3. Diode characteristics:
Reversed dielectric strength: 1,000 V
Forward current: 1 A

Models with Built-in CR Circuits

With CR

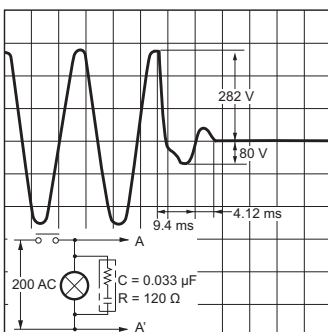

Without CR

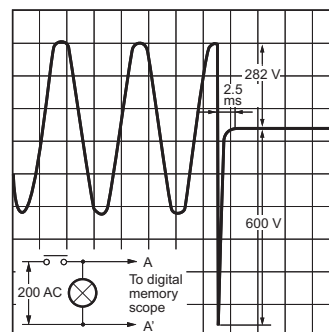

Malfunctioning Shock
LY2 100/110 VAC

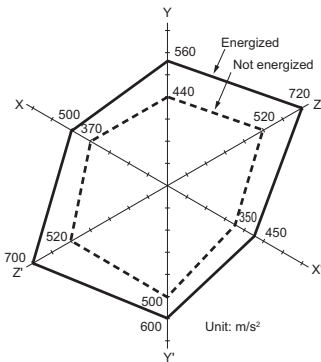

N = 20
Measurement: Shock was applied 2 times each in 6 directions along 3 axes with the Relay energized and not energized to check the shock values that cause the Relay to malfunction.
Criteria: Non-energized: 200 m/s² , Energized: 200 m/s²

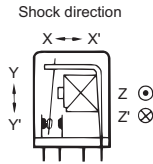

Dimensions

(Unit: mm)

Relays
Solder terminals

LY1
LY1N
LY1-D
LY1N-D2

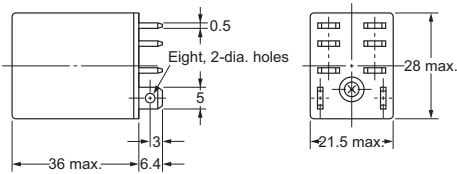
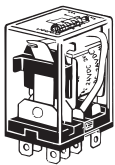

Terminal Arrangement/Internal Connections (Bottom View)

LY1

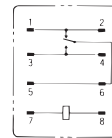

(The coil has no polarity.)

LY1-D

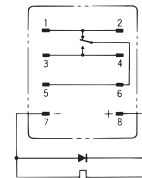

(Check the coil polarity when wiring and wire all connections correctly.)

- Note:**
1. For the DC models, check the coil polarity when wiring and wire all connections correctly.
 2. The indicator is red for AC and green for DC.
 3. The operation indicator indicates the energization of the coil and does not represent contact operation.

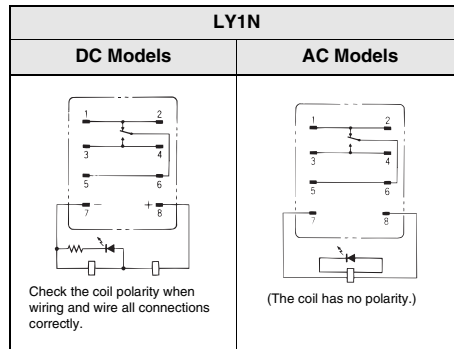

LY1N-D2

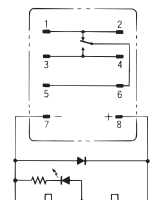

Check the coil polarity when wiring and wire all connections correctly.

LY2
LY2Z
LY2N
LY2ZN

LY2-D
LY2Z-D
LY2N-D2
LY2ZN-D2

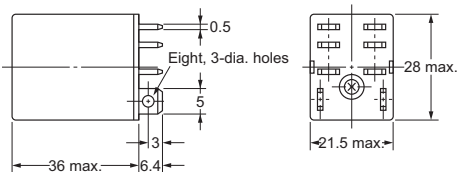
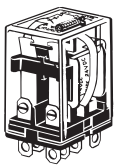

Terminal Arrangement/Internal Connections (Bottom View)

LY2(Z)

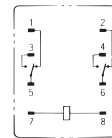

(The coil has no polarity.)

LY2(Z)-D

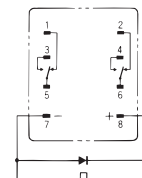

Check the coil polarity when wiring and wire all connections correctly.

- Note:**
1. For the DC models, check the coil polarity when wiring and wire all connections correctly.
 2. The indicator is red for AC and green for DC.
 3. The operation indicator indicates the energization of the coil and does not represent contact operation.

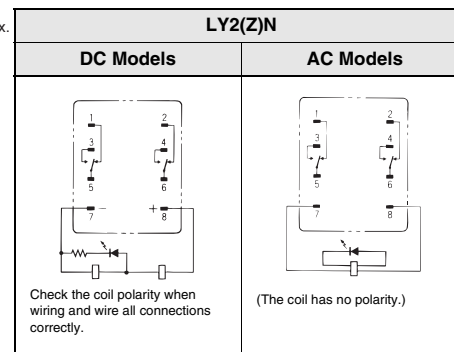

LY2(Z)N-D2

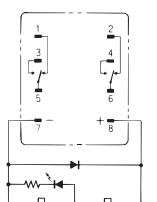

Check the coil polarity when wiring and wire all connections correctly.

**LY4
LY4N
LY4-D
LY4N-D2**

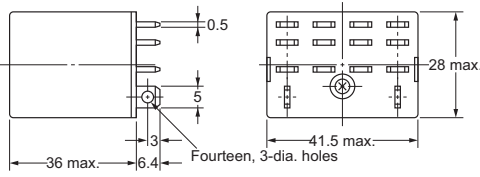
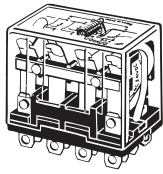

Terminal Arrangement/Internal Connections (Bottom View)

LY4

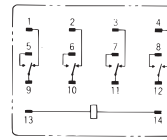

(The coil has no polarity.)

LY4-D

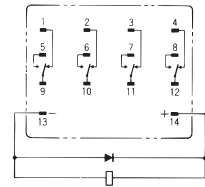

Check the coil polarity when wiring and wire all connections correctly.

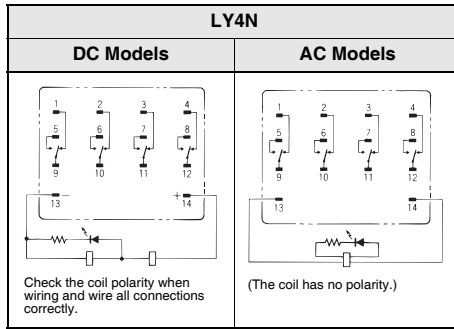

LY4N-D2

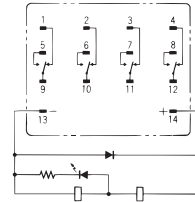

Check the coil polarity when wiring and wire all connections correctly.

- Note:**
1. For the DC models, check the coil polarity when wiring and wire all connections correctly.
 2. The indicator is red for AC and green for DC.
 3. The operation indicator indicates the energization of the coil and does not represent contact operation.

**LY2-CR
LY2Z-CR
LY2N-CR
LY2ZN-CR**

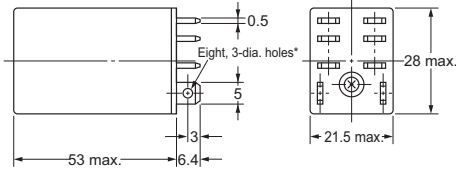

*These dimensions are for the LY2N-CR.

Terminal Arrangement/Internal Connections (Bottom View)

LY2(Z)-CR

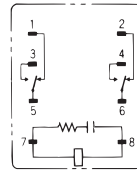

(The coil has no polarity.)

LY2(Z)N-CR

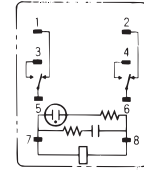

Relays with PCB Terminals

**LY1-0, LY3-0,
LY2-0, and LY4-0**

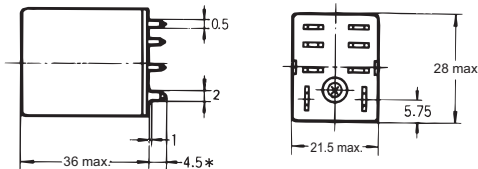
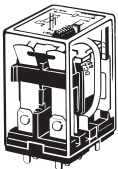

PCB Processing Dimensions (Bottom View)

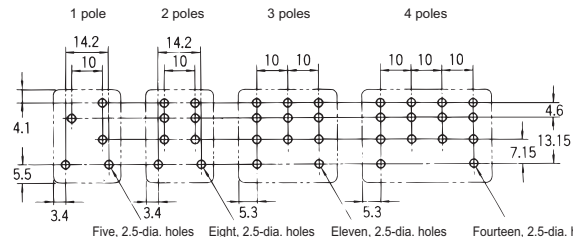

Note: The figures and dimensions depicted here are for the LY2-0. The dimension with an asterisk (*) is 6.4 for the LY1-0.

- Note:**
1. The dimensional tolerance is 0.1 mm.
 2. There are exposed parts (conductive parts) on the LY1-0 other than the terminals. Be careful when using this Relay on a double-sided PCBs.

Terminal Arrangement/Internal Connections (Bottom View)

LY1-0

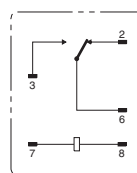

LY2-0

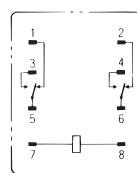

LY3-0

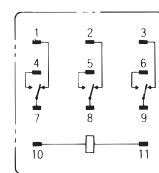

LY4-0

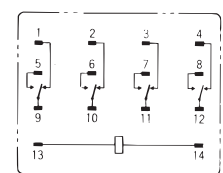

(The coil has no polarity.)

Case-surface mounting

LY1F
LY2F

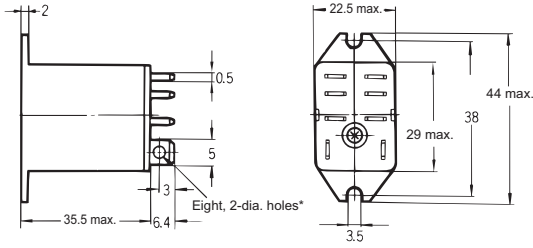
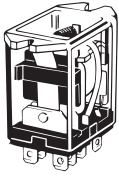

Mounting Hole Dimensions

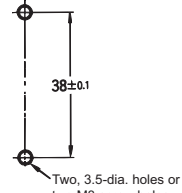

Terminal Arrangement/Internal Connections (Bottom View)



Note: The figures and dimensions depicted here are for the LY1F. The LY2F is also conforms to these measurements.

Note: The dimensional tolerance is ± 0.1 mm.

LY4F

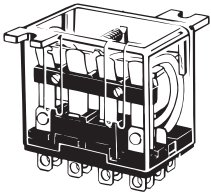

Mounting Hole Dimensions

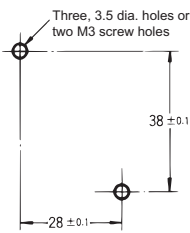

Terminal Arrangement/Internal Connections (Bottom View)



Accessories (Order Separately)

Socket Characteristics

Model	Continuous carry current	Dielectric strength	Insulation resistance *1	Remarks
PTF-□-PU(L)	10 A	Between contact terminals of same polarity: 2,000 VAC, 1 min	1,000 MΩ min.	
		Between contact terminals of different polarity: 2,000 VAC, 1 min		
		Between coil and contact terminals: 2,000 VAC, 1 min		
PTFZ-□□-E	12 A (@ 70°C) 15 A (@ 50°C) *2	Between contact terminals of different polarity: 2,500 VAC, 1 min	1,000 MΩ min.	
		Between contact terminals of same polarity: 2,500 VAC, 1 min		
		Between ground terminals: 2,500 VAC, 1 min		
		Between coil and contact terminals: 2,500 VAC, 1 min		
PTF□□A(-E)	10 A	Between terminals: 2,000 VAC for 1 min	100 MΩ min.	
PT-□□	10 A	Between terminals: 2,000 VAC for 1 min	100 MΩ min.	
PT□□-0	10 A	Between terminals: 2,000 VAC for 1 min	100 MΩ min.	
PT□□QN	10 A	Between terminals: 2,000 VAC for 1 min	100 MΩ min.	



*1. The insulation resistance was measured with a 500-VDC insulation resistance meter at the same places as those used for measuring the dielectric strength.

*2. However, do not exceed the continuous carry current of the socket to be mounted.

Connection Sockets

Dimensions	Terminal Arrangement/ Internal Connections	Mounting Hole Dimensions
<p>PTF-08-PU(-L)</p> <p>* The PTF-08-PU-L Sockets do not have release levers.</p>	<p>(Top View)</p> <p>Note: The numbers in parentheses are traditionally used terminal numbers.</p>	<p>Two, M3 screw hole or two, 3.5 dia. hole</p> <p>(Top View)</p> <p>Note: Pull out the hooks to mount the Relay with screws.</p>

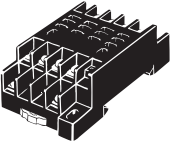
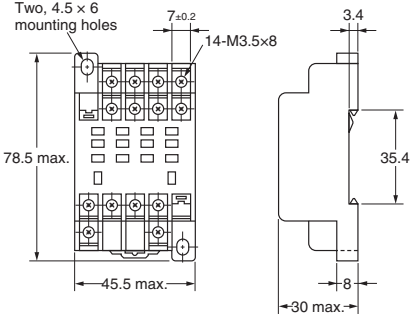
Dimensions	Terminal Arrangement/ Internal Connections	Mounting Hole Dimensions
<p>PTF08A</p>  		
<p>PTFZ-08-E (Finger Protection Structure)</p>  	 <p>(Top View)</p>	 <p>(Top View)</p>
<p>PTF08A-E (Finger Protection Structure)</p>  		<p>Note: Track mounting is also possible.</p>
<p>PTF-14-PU-L</p>  	 <p>(Top View)</p> <p>Note: The numbers in parentheses are traditionally used terminal numbers.</p>	 <p>(Top View)</p> <p>Note: Pull out the hooks to mount the Relay with screws.</p>

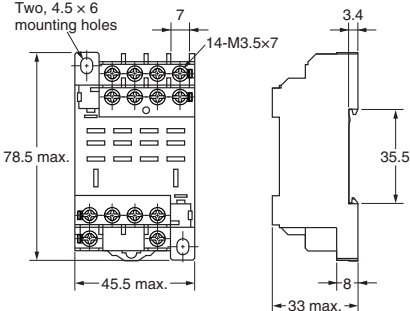
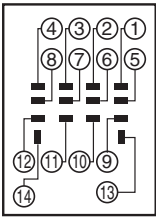
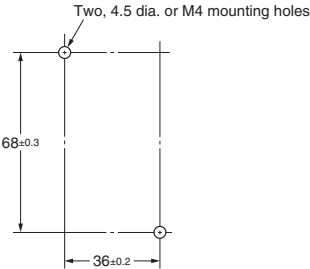
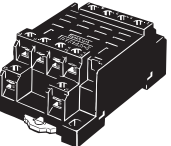
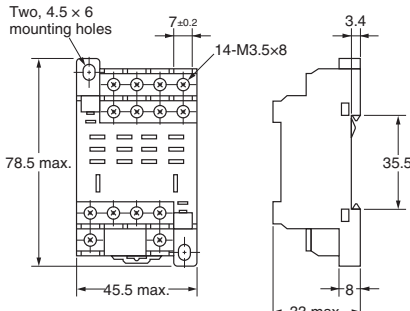
Dimensions	Terminal Arrangement/ Internal Connections	Mounting Hole Dimensions
<p>PTF14A</p>  		
<p>PTFZ-14-E (Finger Protection Structure)</p>  	 <p>(Top View)</p>	 <p>(Top View)</p>
<p>PTF14A-E (Finger Protection Structure)</p>  		<p>Note: Track mounting is also possible.</p>

Note: If you use the PTF-08-PU, PTF-08-PU-L, PTF08A, PTF08A-E, or PT08 with an LY1 Relay, connect the following terminal pairs: 1-2, 3-4, and 5-6 (for usage at 10 A or higher).

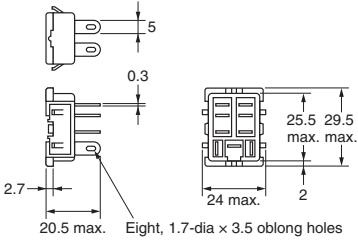
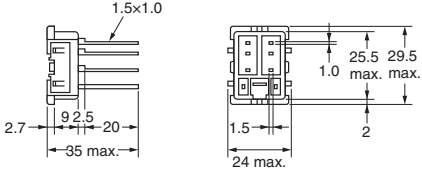
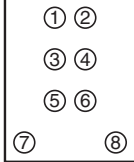
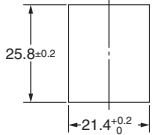
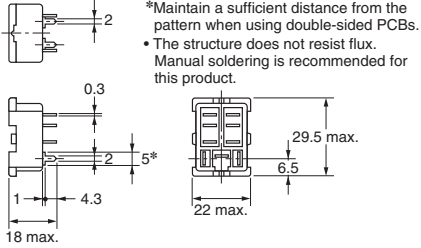
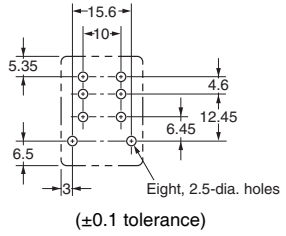
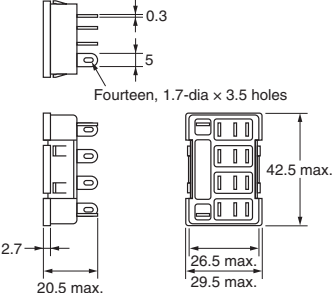
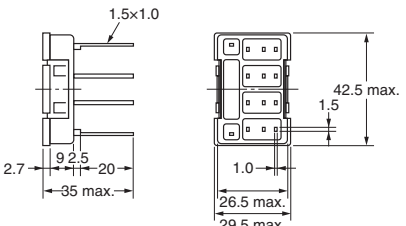
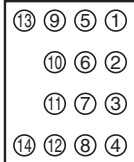
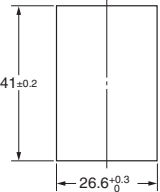
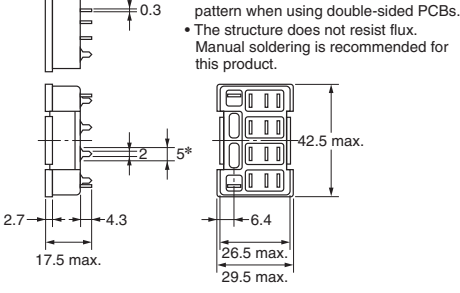
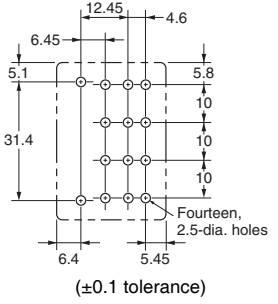
Dimensions	Terminal Arrangement/ Internal Connections	Mounting hole and PCB dimensions
<p>PT08</p>  <p>PT08QN</p> 	 <p>(Bottom View)</p>	
<p>PT08-0</p> 		 <p>(±0.1 tolerance)</p>
<p>PT14</p>  <p>PT14QN</p> 	 <p>(Bottom View)</p>	
<p>PT14-0</p> 		 <p>(±0.1 tolerance)</p>

Note: Use a panel with a thickness of 1 to 2 mm when mounting a Socket on it.

Hold-down Clips

PYC-A1

Approx. 0.54 g (per clip)
One Set (2 Clips)

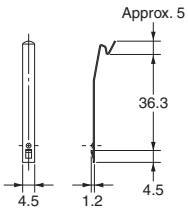

PYC-P

Approx. 1.4 g

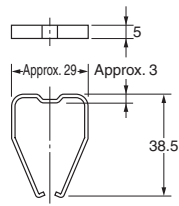

PYC-S

Approx. 1.8 g

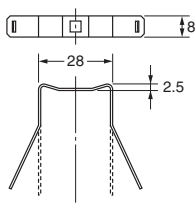

Y92H-3

Approx. 0.7 g (per clip)
One Set (2 Clips)

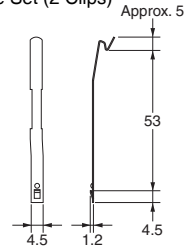

PYC-1

Approx. 6 g

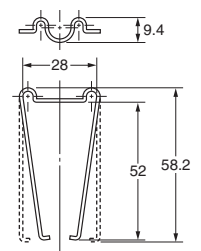

Socket Mounting Plates (t = 1.6)

OMRON can provide Socket Mounting Plate for convenient Socket installation. Please use these Plates as required.



PYP-1

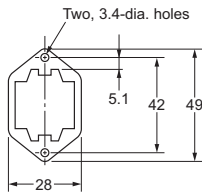

PYP-18

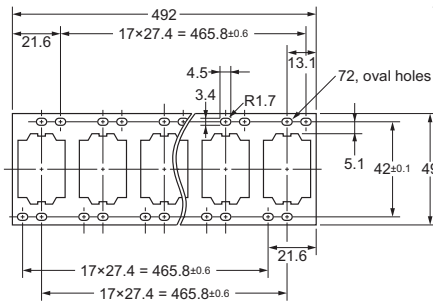

PYP-36

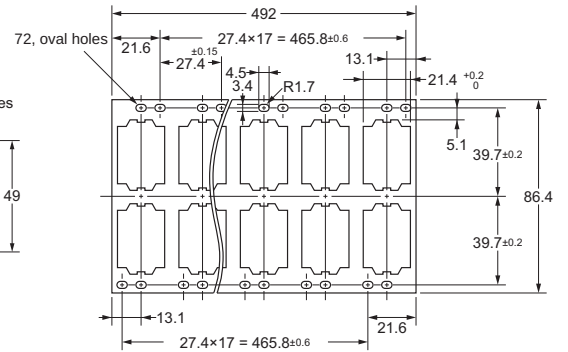

PTP-1

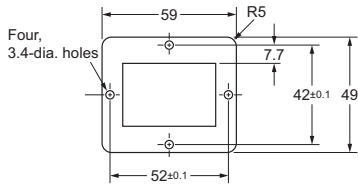

PTP-10

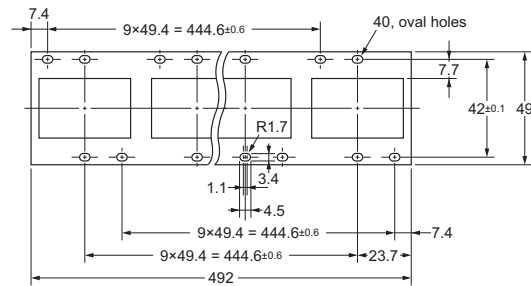

Connection Socket and Hold-down Clip Application Table

Applicable Relay	Item Number of poles	Front-mounting Sockets						Back-mounting Sockets		
		Track or screw mounting						Solder terminals, wrapping terminals, or PCB terminals		
		PTF-08-PU	PTF-08-PU-L	PTF08A	PTF-14-PU-L	PTF14A	Applicable Hold-down Clips	PT08(QN) PT08-0	PT14(QN) PT14-0	Applicable Hold-down Clips
<ul style="list-style-type: none"> Standard models: LY□ Bifurcated contact models: LY□Z Models with built-in operation indicators: LY□N Models with built-in diodes: LY□-D(2) 	1 or 2	*	●	●			PYC-A1	●		PYC-P
	3									
	4				●	●				
<ul style="list-style-type: none"> Models with built-in CR circuits: LY□-CR 	2		●	●			Y92H-3	●		PYC-1

* A Release Lever is provided as a standard feature. The hold-down clips are unnecessary.

Mounting Height with Sockets

Front-mounting Sockets

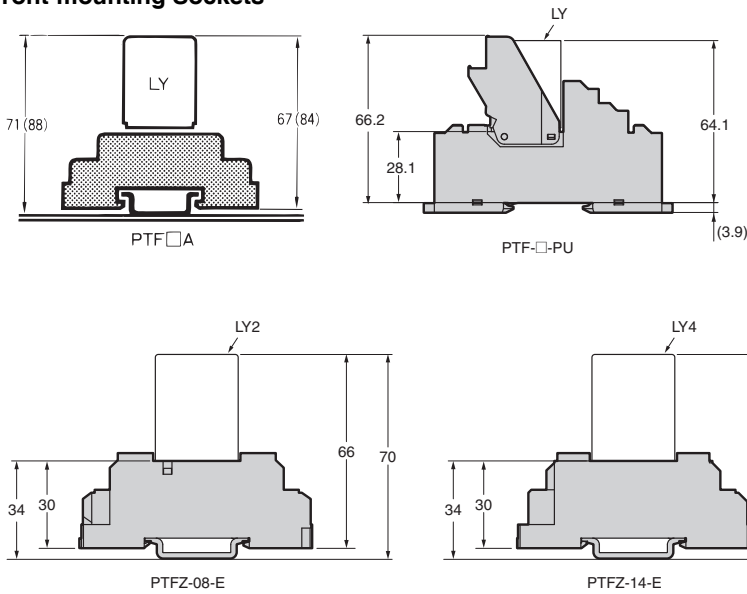

Back-mounting Sockets

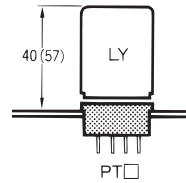

- Note:**
1. The PTF□A can be mounted on a track or with screws.
 2. The measurements in parentheses are for the LY□-CR (built-in CR circuit).

Safety Precautions

Refer to the *Common Relay Precautions* for precautions that apply to all Relays.

Precautions for Correct Use

- Use two M3 screws to attach case-surface-mounted models (LY1F, LY2F, LY3F, and LY4F) and tighten the screws securely. (Normal tightening torque: 0.98 N·m)
- For Relays with Tab Terminals, select a wire diameter for the lead wires that connect to the faston receptacle terminals that is within the allowed range for the load current.
- Do not impose excessive external force on the Relay when inserting the Relay to the faston receptacle or pulling the Relay out from the faston receptacle. Do not attempt to insert a terminal diagonally or insert or pull out more than one terminal at the same time.
- LY Single-contact Relays are for power switching applications. Do not use the LY Series for switching minute loads of 100 mA or less, such as signals.

About the Built-in Diode and CR Elements

The diode or CR element that are built into the Relay are designed to absorb the reverse voltage from the Relay coil. If a large surge in voltage is applied to the diode or CR element from an external source, the element will be destroyed.

If there is the possibility of large voltage surges that could be applied to the elements from an external source, take any necessary surge absorption measures.

Applying 10 A or More When Using an LY1 with the Following Sockets

When you use an LY1 in combination with the PTF-08-PU, PTF-08-PU-L, PTF08A, PTF08A-E, or PT08, connect each of the following terminal pairs: (1) to (2), (3) to (4), and (5) to (6).

Relay Replacement

To replace the Relay, turn OFF the power supply to the load and Relay coil sides to prevent unintended operation and possible electrical shock.

Attaching and Removing Relay Hold-down Clips

When you attach a Hold-down Clip to or remove it from a Socket, wear gloves or take other measures to prevent injuring your fingers on the Hold-down Clip.

OMRON AUTOMATION AMERICAS HEADQUARTERS • Chicago, IL USA • 847.843.7900 • 800.556.6766 • automation.omron.com

OMRON CANADA, INC. • HEAD OFFICE

Toronto, ON, Canada • 416.286.6465 • 866.986.6766 • automation.omron.com

OMRON ELECTRONICS DE MEXICO • HEAD OFFICE

Ciudad de México • 52.55.5901.4300 • 01.800.386.6766 • mela@omron.com

OMRON ELECTRONICS DE MEXICO • SALES OFFICE

San Pedro Garza García, N.L. • 81.12.53.7392 • 01.800.386.6766 • mela@omron.com

OMRON ELECTRONICS DE MEXICO • SALES OFFICE

Eugenio Garza Sada, León, Gto • 01.800.386.6766 • mela@omron.com

OMRON ELETRÔNICA DO BRASIL LTDA • HEAD OFFICE

São Paulo, SP, Brasil • 55 11 5171-8920 • automation.omron.com

OMRON ARGENTINA • SALES OFFICE

Buenos Aires, Argentina • +54.11.4521.8630 • +54.11.4523.8483
mela@omron.com

OTHER OMRON LATIN AMERICA SALES

+54.11.4521.8630 • +54.11.4523.8483 • mela@omron.com

Authorized Distributor:

Controllers & I/O

- Machine Automation Controllers (MAC) • Motion Controllers
- Programmable Logic Controllers (PLC) • Temperature Controllers • Remote I/O

Robotics

- Industrial Robots • Mobile Robots

Operator Interfaces

- Human Machine Interface (HMI)

Motion & Drives

- Machine Automation Controllers (MAC) • Motion Controllers • Servo Systems
- Frequency Inverters

Vision, Measurement & Identification

- Vision Sensors & Systems • Measurement Sensors • Auto Identification Systems

Sensing

- Photoelectric Sensors • Fiber-Optic Sensors • Proximity Sensors
- Rotary Encoders • Ultrasonic Sensors

Safety

- Safety Light Curtains • Safety Laser Scanners • Programmable Safety Systems
- Safety Mats and Edges • Safety Door Switches • Emergency Stop Devices
- Safety Switches & Operator Controls • Safety Monitoring/Force-guided Relays

Control Components

- Power Supplies • Timers • Counters • Programmable Relays
- Digital Panel Meters • Monitoring Products

Switches & Relays



- Limit Switches • Pushbutton Switches • Electromechanical Relays
- Solid State Relays

Software

- Programming & Configuration • Runtime

Looking for pricing, stock, or lifecycle information?

Click below to explore more details on WIN SOURCE:

-  [View PYC-P on WIN SOURCE](#)
-  [Omron Information](#)

Optimize Your Supply Chain with WIN SOURCE Solutions

-  Global Sourcing Solution
-  Obsolete Management
-  Cost Control Management
-  Shortage Management
-  Alternative Solution
-  Excess Inventory Management