



**THE DATASHEET OF
USLPT3020DT6TR**



Applications

- Portable electronic devices.
- 3C products.
- Smart phones.
- Digital cameras.

LPT Series – Low-Profile Tactile Switches

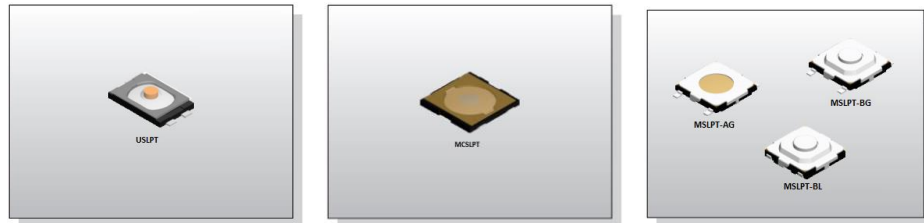

Features

- Compact size.
- Low-profile.
- Long operation life.
- Grounded options available.

TE Connectivity is pleased to introduce its LPT Series of Low-Profile Tactile Switches. Given the various combinations of Size and Height measures offered by the LPT Series, these tactile switches are ideal for a wide variety of applications within the portable electronics market.

The Low-Profile Tactile Switches will be characterised by SMT mounting available in Tab, Gull-Winged, and J-Bend terminations.

LPT Series – Family Classification

Family	USLPT (Ultra-Mini Size)	MCLPT (Micro-Mini Size)	MSLPT (Mini Size)
Body Size	2.6x1.6mm to 3.7x3.7mm	4.6x4.4mm to 4.8x4.8mm	5.2x5.2mm
Height	0.35mm to 0.65mm	0.55mm to 1.05mm	0.80mm to 2.00mm
Mounting	Tab / J-Bend	J-Bend	Gull-Wing / J-Bend
Grounding	No	No	Yes
Packaging	Tape & Reel	Tape & Reel	Tape & Reel

USLPT Family – 3.0 x 2.0mm

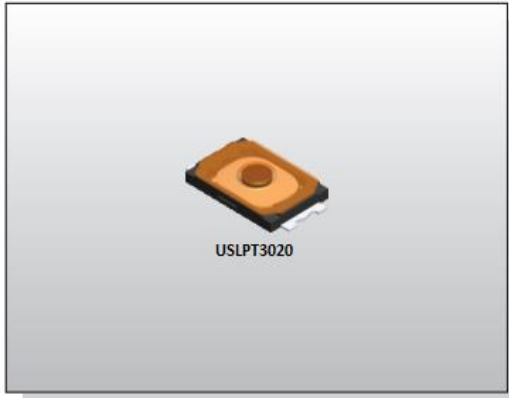
	Contact Rating	10µA, 1VDC Min. 50mA, 12VDC Max.
	Contact Resistance	500mΩ Max.
	Insulation Resistance	100MΩ Min. 100VDC
	Dielectric Strength	100VAC/1 Minute
	Operating Force	160 ± 50gf (-1) 180 ± 50gf (-2) 240 ± 50gf (-3)
	Travel	0.13mm
	Operating Life	300,000 Cycles Min.
	Operating Temperature	-40°C to +85°C
	Storage Temperature	-40°C to +85°C

Features	Applications
<ul style="list-style-type: none"> • Compact size. • Extended operating life. • Ultra-low profile. 	<ul style="list-style-type: none"> • Digital cameras. • Smart Phones. • Portable electronic devices.

Circuit

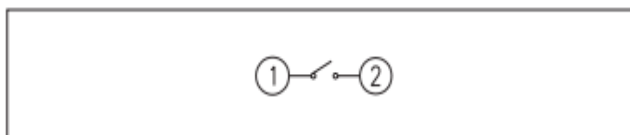

Part Numbering

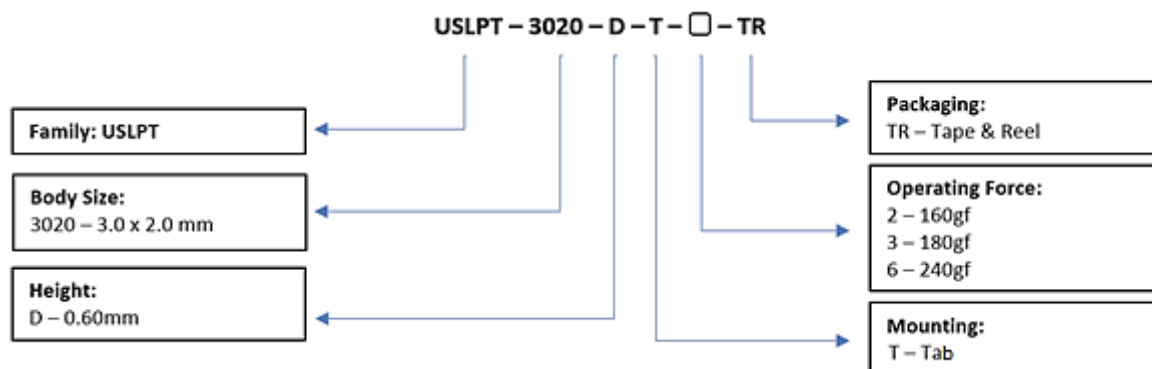

Diagrams

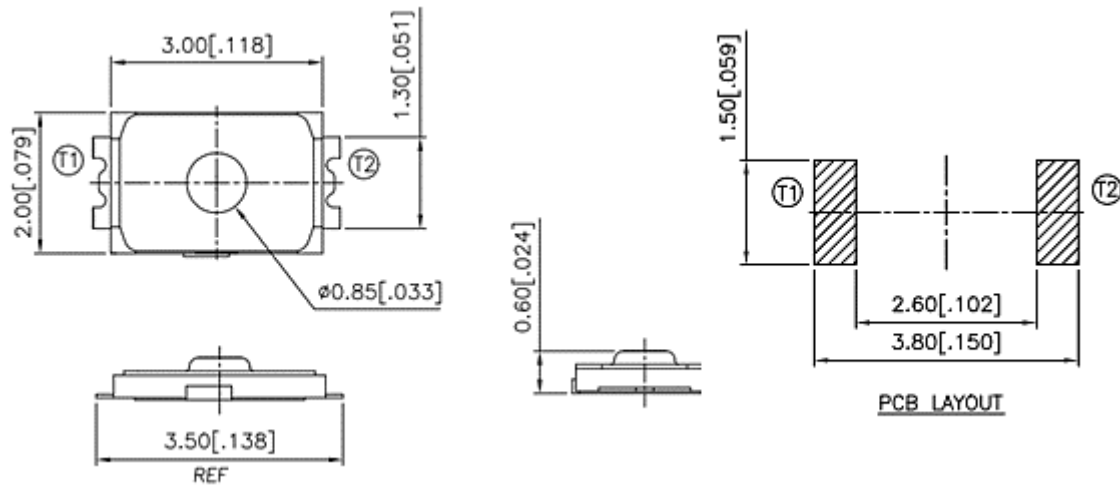

PN List

Smart PN	Body Size	Height	Mounting	Operation Force	Packaging	MOQ	TE PN
USLPT3020DT2TR	3.0 x 2.0mm	0.60mm	Tab	160gf	Tape and Reel	2,500	2337230-1
USLPT3020DT3TR	3.0 x 2.0mm	0.60mm	Tab	180gf	Tape and Reel	2,500	2337230-2
USLPT3020DT6TR	3.0 x 2.0mm	0.60mm	Tab	240gf	Tape and Reel	2,500	2337230-3

1. Style

“Tactile Switches” are mainly used as signal switches of electric devices, with the general requirements of mechanical and electrical characteristic.

1.1 Operating Temperature Range: -40 °C to +85°C

1.2 Storage Temperature Range: -40 °C to +85°C

2. Current Range: 10µA, 1VDC Min. to 50 mA, 12VDC Max.

3. Type of Actuation: Tactile feedback

4. Test Sequence:

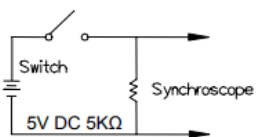
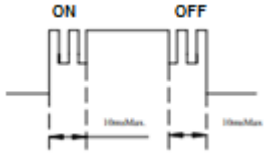
	Item	Description	Test Conditions	Requirements
Appearance	1	Visual Examination	By visual examination check without any out pressure & testing.	There shall be no defects that affect the serviceability of the product.
Electrical Performance	2	Contact Resistance	Applying a static load (1.5 to 2x actuating force) to the centre of the actuator. Measurements shall be made with a 1 kHz small current contact resistance meter.	500mΩ Max.
	3	Insulation Resistance	Measurements shall be made following application of 100VDC potential across terminals and cover for 1 minute± 5 seconds.	100MΩ Min.
	4	Dielectric Withstanding Voltage	100VAC (50Hz or 60Hz) shall be applied across terminals and cover for 1 minute.	There shall be no breakdown or flashover.
	5	Bounce	3 to 4 operations at a rate of 1 cycles per second 	10 m seconds Max. 

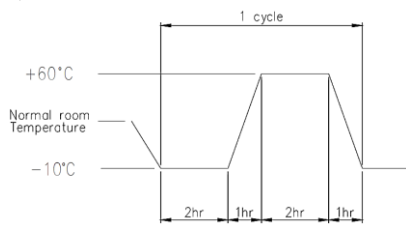

Mechanical Performance	6	Operating Force	Applied in the direction of operation.	160±50gf (1.569±0.49N)	180±50gf (1.765±0.49N)	240±50gf (2.354±0.49N)
	7	Stroke	Placing the switch such that the direction of switch operation is vertical and then gradually increasing the load applied to the centre of the actuator to a stop shall be measured.	0.13±0.05mm		
	8	Control strength	Static load of 3Kg (29.4N) shall be applied in the operating direction of the control unit for 15 seconds.	As shown in items 2 to 6.		
	9	Solder Heat Resistance	(PCB is 0.8mm in thickness)	1) Shall be free from pronounced backlash and falling-off or breakage Terminals. 2) As shown in item 2 to 5.		
	10	Vibration	Shall be vibrated in accordance with Method 201A of MIL-STD-202F 1) Swing distance=1.5mm. 2) Frequency: 10-55-10Hz in 1-min/cycle. 3) Direction: 3 vertical directions including the directions of operation. 4) Test time: 2 hours each direction.	As shown in item 2 to 6.		
	11	Shock	Shall be shocked in accordance with Method 213B condition A of MIL-STD-202F 1) Acceleration: 50G. 2) Action Time: 11±1m sec. 3) Testing Direction: 6 sides. 4) Test cycle: 3 times in each direction.	As shown in item 2 to 6.		
Durability	12	Operating Life	Measurements shall be made following the test forth below: 1) 5mA, 5VDC resistive load. 2) Rate of Operation: 2 to 3 operations per second. 3) Applying a static load the operating force to the centre of the actuator in the direction of operation. 4) Cycle of Operation= ■ 300,000 Cycles Min.	1) As shown in item 4. 2) Operating force: ±30% of initial force. 3) Contact Resistance: 1Ω Max. 4) Insulation Resistance: 10MΩ Min. 5) Bounce: 20m seconds Max.		

Environmental Endurance	13	Low Temperature Resistance	Following the test set forth below the sample shall be left in normal temperature and humidity conditions for 1 hour before the measurements are made: 1) Temperature: $-40\pm 2^{\circ}\text{C}$ 2) Time: 96 hours	As shown in item 2 to 6.
	14	High Temperature Resistance	Following the test set forth below the sample shall be left in normal temperature and humidity conditions for 1 hour before the measurements are made: 1) Temperature: $90\pm 2^{\circ}\text{C}$ 2) Time: 96 hours	As shown in item 2 to 6.
	15	Humidity Resistance	Following the test set forth below the sample shall be left in normal temperature and humidity conditions for 1 hour before the measurements are made: 1) Temperature: $60\pm 2^{\circ}\text{C}$ 2) Relative Humidity: 90 to 95% 3) Time: 96 hours	1) As shown in item 4 to 6. 2) Contact resistance: Less than 1Ω . 3) Insulation resistance: More than $10\text{M}\Omega$.
	16	Temperature Cycle	1) Test cycles: 5 cycles 2) Standard conditions after test: 	1. As shown in item 2 to 6.

5. Soldering Conditions:

- Condition for Soldering USLPT Series:

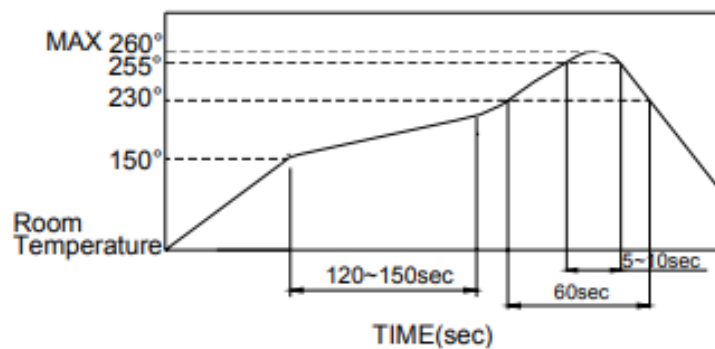

- The condition noted above is the temperature of the copper foil on the surface of the PCB. There are cases where the temperature of the board greatly differs from the surface of the switch. Do not allow the surface temperature of the switch to exceed 260°C .

■ Manual Soldering

Soldering Temperature: 350°C Max.

Continuous Soldering Time: 5 second Max.

■ Precautions in Handling

1. Care should be exercised so that flux from the top surface of the printed circuit board does not adhere to the switch.
2. Do not wash the switch.

■ Operating precautions

1. Do not actuate the switch with excessive force.
2. Discontinue force after the switch has been actuated so as to avoid deformation of the components of the switch. Deformation of the components may cause the switch to malfunction.
3. Align the plunger with the switch to insure proper operation.

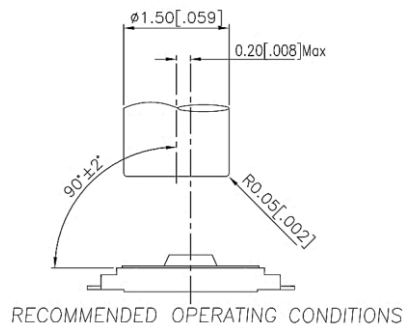

■ Notes on storage conditions

Avoid the following as exposure may affect the performance and/or the soldering of the switch:

1. Temperature of -10 to +40°C & 85% humidity.
2. Exposure to corrosive gas.
3. Storage over 6 months
4. Exposure to direct sunlight.
5. Storage conditions should prevent heavy impact or loading.
6. After opening the package, unused switches must be repackaged in a moisture-proof and airtight environment.

Looking for pricing, stock, or lifecycle information?

Click below to explore more details on WIN SOURCE:

- ⊖ [View USLPT3020DT6TR on WIN SOURCE](#)
- ⊖ [TE Connectivity Information](#)

Optimize Your Supply Chain with WIN SOURCE Solutions

- ✓ Global Sourcing Solution
- ✓ Obsolete Management
- ✓ Cost Control Management
- ✓ Shortage Management
- ✓ Alternative Solution
- ✓ Excess Inventory Management