



THE DATASHEET OF HLMP-C315



HLMP-C115, HLMP-C123, HLMP-C215, HLMP-C223, HLMP-C315, HLMP-C323, HLMP-C415, HLMP-C423, HLMP-C515, HLMP-C523, HLMP-C615

T-1^{3/4} Super Ultra-Bright LED Lamps

Description

These Broadcom® non-diffused lamps are designed to produce a bright light source and smooth radiation pattern. This lamp has been designed with a 20-mil lead frame, enhanced flange, and tight meniscus controls, making it compatible with radial lead automated insertion equipment.

Features

- Very high intensity
- AllInGaP LED technology
- Exceptional uniformity
- Consistent viewability
- All colors:
 - Deep Red
 - Red
 - Yellow
 - Orange
 - Green
 - Emerald Green
- 15° and 25° family
- Tape and reel options available
- Binned for color and intensity

Applications

- Ideal for backlighting front panels*
- Used for lighting switches
- Adapted for indoor and outdoor signs

Package Dimensions

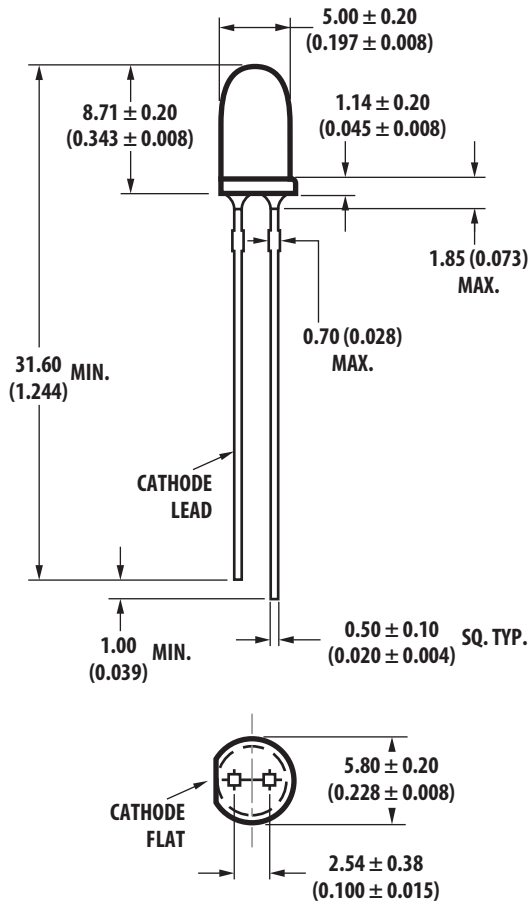

NOTE:

1. All dimensions are in millimeters (inches).
2. An epoxy meniscus may extend about 0.5 mm (0.020 in.) down the leads.
3. For PCB hole recommendations, see [Precautions](#).

Device Selection Guide

Color	Viewing Angle (Degrees) $2\theta_{1/2}$ ^a	Standoff Leads	Part Number	Luminous Intensity I_v (mcd)	
				Min.	Max.
Deep Red	15	No	HLMP-C115	290.0	—
	25	No	HLMP-C123-L00xx	90.2	—
Red	15	No	HLMP-C215	138.0	—
	25	No	HLMP-C223	90.2	—
Yellow	15	No	HLMP-C315	147.0	—
	25	No	HLMP-C323	96.2	—
Orange	15	No	HLMP-C415	138.0	—
	25	No	HLMP-C423	90.2	—
			HLMP-C423-L00xx	90.2	—
Green	15	No	HLMP-C515	170.0	—
			HLMP-C515-L00xx	170.0	—
	25	No	HLMP-C523	69.8	—
			HLMP-C523-J00xx	69.8	—
Emerald Green	15	No	HLMP-C615-G00xx	17.0	—

a. $\theta_{1/2}$ is the off-axis angle at which the luminous intensity is half the axial luminous intensity.

Absolute Maximum Ratings at $T_A = 25^\circ\text{C}$

Parameter	Deep Red	Red and Orange	Yellow	Green and Emerald Green	Units
DC Forward Current ^a	30	30	20	30	mA
Reverse Voltage ($I_R = 100 \mu\text{A}$)	5	5	5	5	V
LED Junction Temperature	110	110	110	110	$^\circ\text{C}$
Operating Temperature Range	-20 to +100	-40 to +100	-40 to +100	-20 to +100	$^\circ\text{C}$
Storage Temperature Range	-40 to +100	-40 to +100	-40 to +100	-40 to +100	$^\circ\text{C}$

a. See [Figure 5](#) and [Figure 6](#) for maximum current derating vs. ambient temperature.

Electrical Characteristics at $T_A = 25^\circ\text{C}$

Part Number	Forward Voltage V_F (Volts) at $I_F = 20\text{ mA}$		Reverse Breakdown V_R (Volts) at $I_R = 100\ \mu\text{A}$	Capacitance C (pF) $V_F = 0$, $f = 1\text{ MHz}$	Thermal Resistance $R_{\theta\text{J-PIN}}$ ($^\circ\text{C/W}$)	Speed of Response τ_s (ns) Time Constant e^{-t/τ_s}
	Typ.	Max.	Min.	Typ.		Typ.
HLMP-C115 HLMP-C123	2.0	2.4	5	30	210	30
HLMP-C215 HLMP-C223	2.0	2.6	5	11	210	90
HLMP-C315 HLMP-C323	2.0	2.6	5	15	210	90
HLMP-C415 HLMP-C423	2.0	2.6	5	4	210	280
HLMP-C515 HLMP-C523	2.1	3.0	5	18	210	260
HLMP-C615	2.2	3.0	5	18	210	260

Optical Characteristics at $T_A = 25^\circ\text{C}$

Part Number	Luminous Intensity I_v (mcd) at 20 mA^a		Peak Wavelength λ_{peak} (nm)	Color, Dominant Wavelength λ_d^b (nm)	Viewing Angle $2\theta_{1/2}$ (Degrees) ^c	Luminous Efficacy η_v (lm/w)
	Min.	Typ.	Typ.	Typ.	Typ.	
HLMP-C115	290	600	660	640	11	65
HLMP-C123	90	200			26	
HLMP-C215	138	300	632	626	17	180
HLMP-C223	90	170			23	
HLMP-C315	146	300	590	589	17	500
HLMP-C323	96	170			25	
HLMP-C415	138	300	610	605	17	350
HLMP-C423	90	170			23	
HLMP-C515	170	300	570	569	20	640
HLMP-C523	69	170			28	
HLMP-C615	17	45	560	559	20	660

- The luminous intensity, I_v , is measured at the mechanical axis of the lamp package. The actual peak of the spatial radiation pattern may not be aligned with this axis.
- The dominant wavelength, λ_d , is derived from the CIE Chromaticity Diagram and represents the color of the device.
- $2\theta_{1/2}$ is the off-axis angle where the luminous intensity is $1/2$ the on-axis intensity.

Part Numbering System

H L M P -

x ₁	x ₂	x ₃	x ₄
----------------	----------------	----------------	----------------

 -

x ₅	x ₆	x ₇	x ₈	x ₉
----------------	----------------	----------------	----------------	----------------

Code	Description	Option	
x ₁	Package Type	C	T -1¼ (5 mm)
x ₂	Color	1	Deep Red
		2	Red
		3	Yellow
		4	Orange
		5	Green
		6	Emerald Green
x ₃ x ₄	Viewing Angle and Stand-off Option	15	15° without Stand-off
		23	25° without Stand-off
x ₅	Minimum Intensity Bin	See Intensity Bin Limits	
x ₆	Maximum Intensity Bin	0	Open Bins (no max Iv bin limit)
x ₇	Color Bin Option	0	Full distribution
x ₈ x ₉	Packing Option	00	Bulk (loose forms packaging)
		01	Tape and Reel, Crimped Leads
		02	Tape and Reel, Straight Leads
		B2	Right Angle Housing, Even Leads

Bin Information

Intensity Bin Limits

Color	Bin	Intensity Range (mcd)	
		Min.	Max.
Red/Orange	L	101.5	162.4
	M	162.4	234.6
	N	234.6	340.0
	O	340.0	540.0
	P	540.0	850.0
	Q	850.0	1200.0
	R	1200.0	1700.0
	S	1700.0	2400.0
	T	2400.0	3400.0
	U	3400.0	4900.0
	V	4900.0	7100.0
	W	7100.0	10200.0
	X	10200.0	14800.0
	Y	14800.0	21400.0
Z	21400.0	30900.0	
Yellow	L	173.2	250.0
	M	250.0	360.0
	N	360.0	510.0
	O	510.0	800.0
	P	800.0	1250.0
	Q	1250.0	1800.0
	R	1800.0	2900.0
	S	2900.0	4700.0
	T	4700.0	7200.0
	U	7200.0	11700.0
	V	11700.0	18000.0
W	18000.0	27000.0	

Color	Bin	Intensity Range (mcd)	
		Min.	Max.
Green/ Emerald Green	E	7.6	12.0
	F	12.0	19.1
	G	19.1	30.7
	H	30.7	49.1
	I	49.1	78.5
	J	78.5	125.7
	K	125.7	201.1
	L	201.1	289.0
	M	289.0	417.0
	N	417.0	680.0
	O	680.0	1100.0
	P	1100.0	1800.0
	Q	1800.0	2700.0
	R	2700.0	4300.0
	S	4300.0	6800.0
	T	6800.0	10800.0
	U	10800.0	16000.0
	V	16000.0	25000.0
	W	25000.0	40000.0

Maximum tolerance for each bin limit is ± 18%.

Color Categories

Color	Category Number	Lambda (nm)	
		Min.	Max.
Green	6	561.5	564.5
	5	564.5	567.5
	4	567.5	570.5
	3	570.5	573.5
	2	573.5	576.5
Yellow	1	582.0	584.5
	3	584.5	587.0
	2	587.0	589.5
	4	589.5	592.0
	5	592.0	593.0
Orange	1	597.0	599.5
	2	599.5	602.0
	3	602.0	604.5
	4	604.5	607.5
	5	607.5	610.5
	6	610.5	613.5
	7	613.5	616.5
	8	616.5	619.5

Tolerance for each bin limit is ± 0.5 nm.

Packaging Option Matrix

Packaging Option Code	Definition
00	Bulk Packaging, minimum increment 500 pieces/bag
01	Tape and Reel, crimped leads, minimum increment 1300 pieces/reel
02	Tape and Reel, straight leads, minimum increment 1300 pieces/reel
B2	Right Angle Housing, even leads, minimum increment 500 pieces/bag

NOTE: All categories are established for classification of products. Products may not be available in all categories. Contact your local Broadcom representative for further clarification and information.

Figure 1: Relative Intensity vs. Wavelength

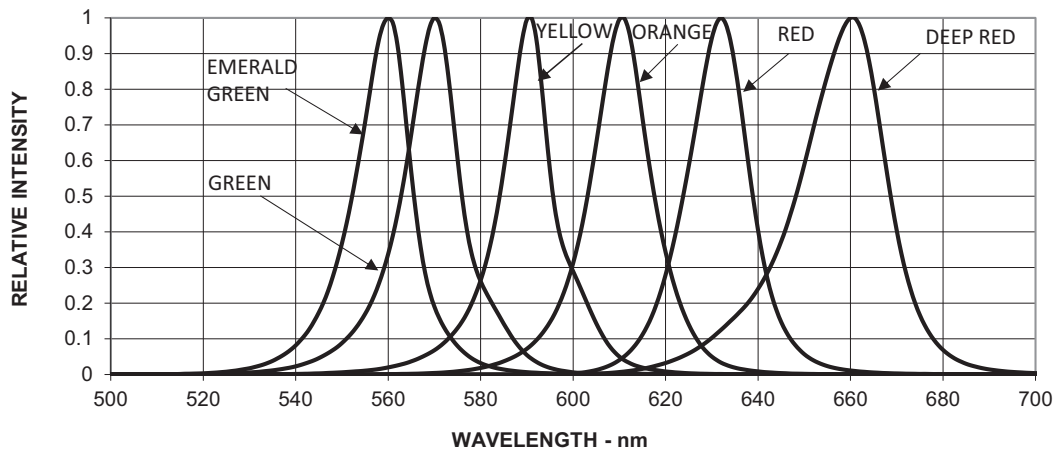

Figure 2: Forward Current vs. Forward Voltage

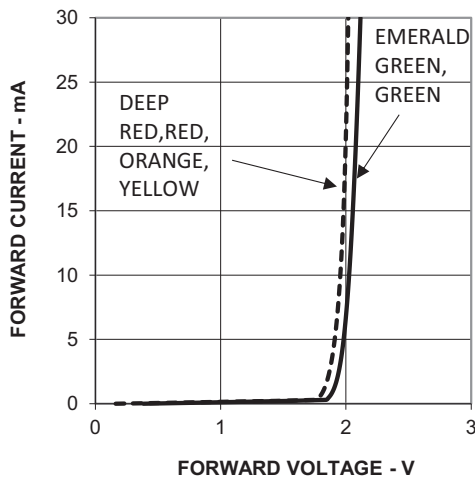

Figure 3: Relative Luminous Intensity vs. Forward Current (Deep Red, Red, and Yellow)

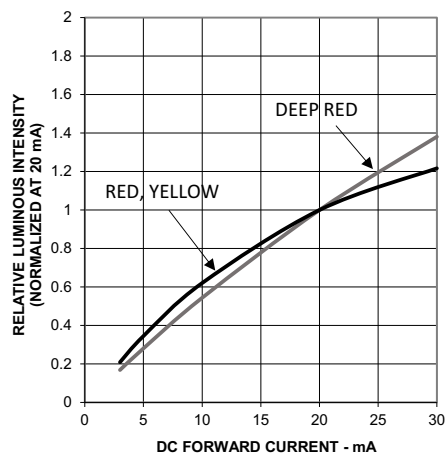

Figure 4: Relative Luminous Intensity vs. Forward Current (Green, Emerald Green, and Orange)

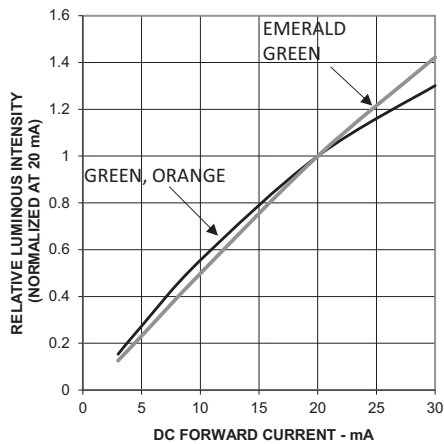

Figure 5: Maximum Forward DC Current vs. Ambient Temperature. Derating based on $T_{JMAX} = 110^{\circ}C$.

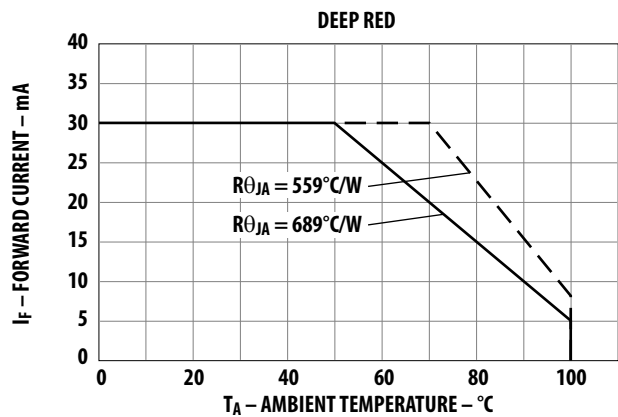

Figure 6: Maximum Forward DC Current vs. Ambient Temperature. Derating based on $T_{JMAX} = 110^{\circ}C$.

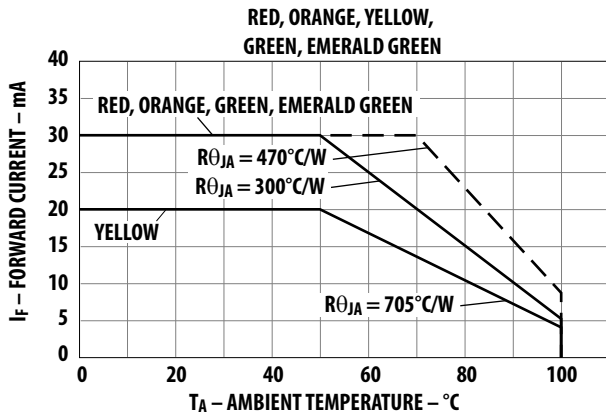

Figure 7: Relative Luminous Intensity vs. Angular Displacement – 15° Family

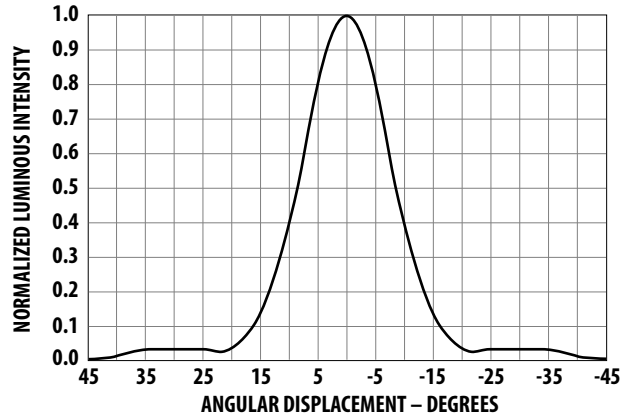
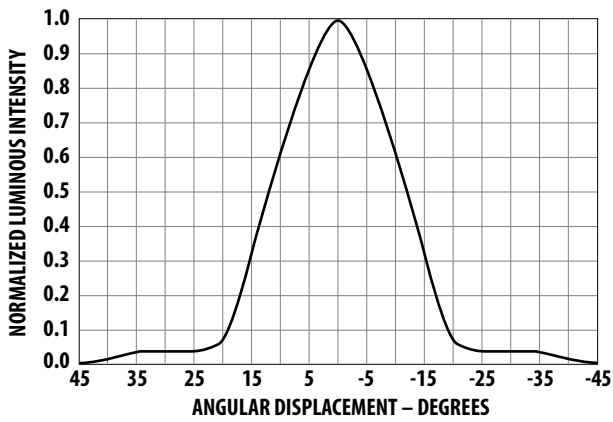

Figure 8: Relative Luminous Intensity vs. Angular Displacement – 25° Family



Precautions

Lead Forming

- Preform or cut to length the leads of an LED lamp prior to insertion and soldering on PC board.
- For better control, use the proper tool to precisely form and cut the leads to applicable length rather than doing it manually.
- If manual lead cutting is necessary, cut the leads after the soldering process. The solder connection forms a mechanical ground that prevents mechanical stress due to lead cutting from traveling into LED package. use this process for the hand solder operation, because the excess lead length also acts as small heat sink.

Soldering and Handling

- Take care during the PCB assembly and soldering process to prevent damage to the LED component.
- LED component may be effectively hand soldered to PCB. However, do this only under unavoidable circumstances, such as rework. The closest manual soldering distance of the soldering heat source (soldering iron's tip) to the body is 1.59 mm. Soldering the LED using soldering iron tip closer than 1.59 mm might damage the LED.

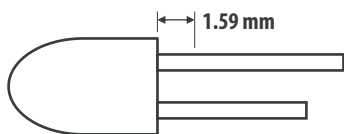

- Apply ESD precautions on the soldering station and by personnel to prevent ESD damage to the LED component, which is ESD sensitive. For details, refer to Broadcom application note AN 1142. The soldering iron must have a grounded tip to ensure that the electrostatic charge is properly grounded.
- Recommended soldering conditions follow.

	Wave Soldering ^{a, b}	Manual Solder Dipping
Pre-heat Temperature	105°C max.	—
Pre-heat Time	60s max.	—
Peak Temperature	250°C max.	260°C max.
Dwell Time	3s max.	5s max.

- These conditions refer to measurement with a thermocouple mounted at the bottom of PCB.
- To reduce thermal stress experienced by the LED, use only the bottom preheaters.

- Set and maintain wave soldering parameters according to the recommended temperature and dwell time. Perform daily checks on the soldering profile to ensure that it always conforms to the recommended soldering conditions.

NOTE:

1. PCBs with different sizes and designs (component density) have different heat mass (heat capacity). This might cause a change in temperature experienced by the board if the same wave soldering setting is used. So, re-calibrate the soldering profile again before loading a new type of PCB.
 2. Take extra precautions during wave soldering to ensure that the maximum wave temperature does not exceed 250°C and the solder contact time does not exceed 3s. Over-stressing the LED during soldering process might cause premature failure to the LED due to delamination.
- Loosely fit any alignment fixture that is being applied during wave soldering and it should not apply weight or force on the LED. Use non-metal material because it absorbs less heat during the wave soldering process.
 - At elevated temperature, the LED is more susceptible to mechanical stress. Therefore, allow the PCB to cool down to room temperature prior to handling, which includes removal of alignment fixture or pallet.
 - If the PCB board contains both through hole (TH) LEDs and other surface mount components, solder the surface mount components on the top side of the PCB. If surface mount must be on the bottom side, solder these components using reflow soldering prior to inserting the TH LED.
 - The recommended PC board plated through holes (PTH) size for LED component leads follows.

	LED Component Lead Size	Diagonal	Plated Through-Hole Diameter
Lead size (typ.)	0.45 × 0.45 mm (0.018 × 0.018 in.)	0.636 mm (0.025 in.)	0.98 to 1.08 mm (0.039 to 0.043 in.)
Dambar shear-off area (max.)	0.65 mm (0.026 in.)	0.919 mm (0.036 in.)	
Lead size (typ.)	0.50 × 0.50 mm (0.020 × 0.020 in.)	0.707 mm (0.028 in.)	1.05 to 1.15 mm (0.041 to 0.045 in.)
Dambar shear-off area (max.)	0.70 mm (0.028 in.)	0.99 mm (0.039 in.)	

- Over-sizing the PTH can lead to a twisted LED after it is clinched. On the other hand, undersizing the PTH can make inserting the TH LED difficult.

For more information about soldering and handling of TH LED lamps, refer to application note AN5334.

Figure 9: Example of Wave Soldering Temperature Profile for TH LED

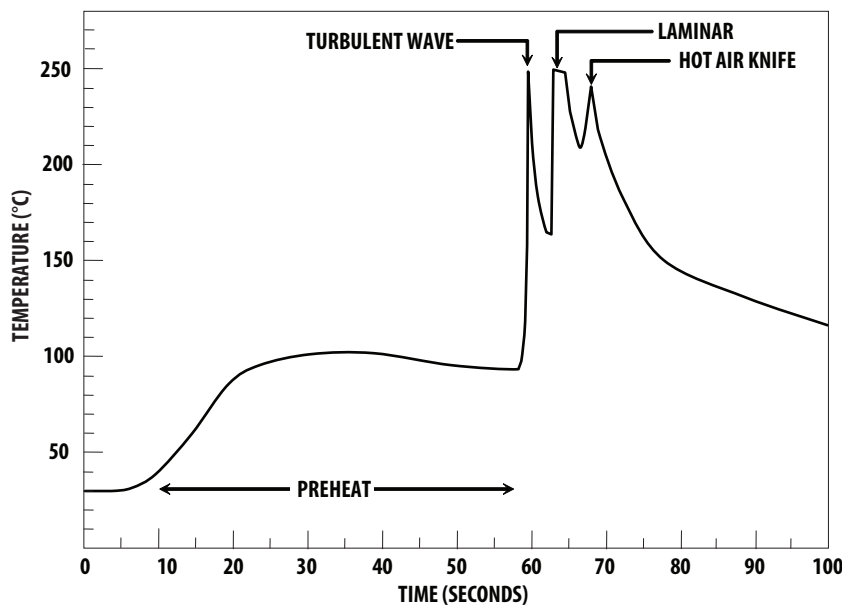

Recommended solder:
Sn63 (Leaded solder alloy)
SAC305 (Lead free solder alloy)

Flux: Rosin flux

Solder bath temperature:
245°C ± 5°C (maximum peak temperature = 250°C)

Dwell time: 1.5 sec – 3.0 sec (maximum = 3sec)

Note: Allow for board to be sufficiently cooled to room temperature before exerting mechanical force.

Recommended solder:
Sn63 (Leaded solder alloy)
SAC305 (Lead free solder alloy)

Flux: Rosin flux

Solder bath temperature:
245°C ± 5°C (maximum peak temperature = 250°C)

Dwell time: 1.5 sec – 3.0 sec (maximum = 3sec)







Note: Allow for board to be sufficiently cooled to room temperature before exerting mechanical force.

Packaging Label

(i) Mother Label: (Available on packaging box of ammo pack and shipping box)

Avago TECHNOLOGIES	
STANDARD LABEL LS0002	
RoHS Compliant	
e3 max temp 250C	
(1P) Item: <u>Part Number</u>	(Q) QTY: <u>Quantity</u>
(1T) Lot: <u>Lot Number</u>	CAT: <u>Intensity Bin</u>
LPN:	BIN: <u>Color Bin</u>
(9D)MFG Date: <u>Manufacturing Date</u>	
(P) Customer Item:	
(V) Vendor ID:	(9D) Date Code: <u>Date Code</u>
DeptID:	Made In: <u>Country of Origin</u>

(ii) Baby Label (Only available on bulk packaging)

AVAGO TECHNOLOGIES		RoHS Compliant	
Lamps Baby Label		e3 max temp 250C	
(1P) PART #: Part Number			
(1T) LOT #: Lot Number			
(9D)MFG DATE: Manufacturing Date	QUANTITY: Packing Quantity		
C/O: Country of Origin			
Customer P/N:	CAT: Intensity Bin		
Supplier Code:	BIN: Color Bin		
	DATECODE: Date Code		

Copyright © 2016–2021 Broadcom. All Rights Reserved. The term “Broadcom” refers to Broadcom Inc. and/or its subsidiaries. For more information, go to www.broadcom.com. All trademarks, trade names, service marks, and logos referenced herein belong to their respective companies.

Broadcom reserves the right to make changes without further notice to any products or data herein to improve reliability, function, or design. Information furnished by Broadcom is believed to be accurate and reliable. However, Broadcom does not assume any liability arising out of the application or use of this information, nor the application or use of any product or circuit described herein, neither does it convey any license under its patent rights nor the rights of others.

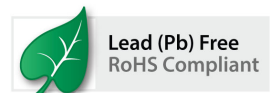

Looking for pricing, stock, or lifecycle information?

Click below to explore more details on WIN SOURCE:

 [View HLMP-C315](#) on WIN SOURCE

 [Broadcom Limited](#) Information

Optimize Your Supply Chain with WIN SOURCE Solutions

-  Global Sourcing Solution
-  Obsolete Management
-  Cost Control Management
-  Shortage Management
-  Alternative Solution
-  Excess Inventory Management