



**THE DATASHEET OF
NX5P2553GU6Z**



NX5P2553

Precision adjustable current-limited power switch

Rev. 1 — 6 July 2015

Product data sheet

1. General description

The NX5P2553 is a precision adjustable current-limited power switch. The device includes undervoltage lockout, overtemperature, and reverse bias protection circuits designed to isolate the switch terminals when a fault condition occurs. It also has an overcurrent protection circuit to limit the output current. The device features two power switch terminals, one input (VIN), and one output (VOUT). It also consists of a current limit input (ILIM) for defining the overcurrent limit, an open-drain fault output ($\overline{\text{FAULT}}$) to indicate when a fault condition has occurred, and an enable input (EN) to control the state of the switch.

The overcurrent limit threshold can be programmed between 85 mA and 1.8 A using an external resistor between the ILIM and GND pins. The device has built-in soft-start. This feature controls the output rise time by minimizing current surges when the switch is enabled.

Designed for operation from 2.5 V to 5.5 V, it is used in power domain isolation applications to protect from out of range operation. The enable input includes integrated logic level translation making the device compatible with lower voltage processors and controllers.

2. Features and benefits

- Wide supply voltage range from 2.5 V to 5.5 V
- I_{SW} maximum 1.5 A continuous current
- $\pm 6\%$ current-limit accuracy at 1.8 A (typical)
- Meets USB current-limiting requirements
- Adjustable current limit from 85 mA to 1800 mA (typical)
- Constant current mode in overcurrent situation
- Overtemperature protection
- Very low ON resistance: 95 m Ω (typical) for TSOP6 package
- Fast short-circuit switch-off response (2.0 μ s typical)
- ILIM short detection
- Reverse input-output voltage protection
- Built-in soft-start
- ESD protection:
 - ◆ HBM ANSI/ESDA/JEDEC JS-001-2012 Class 2 exceeds 2000 V
 - ◆ CDM JESD22-C101D exceeds 500 V
 - ◆ IEC61000-4-2 contact discharge exceeds 8 kV for VOUT (with external capacitance)
- Specified from $-40\text{ }^{\circ}\text{C}$ to $+85\text{ }^{\circ}\text{C}$ ambient temperature



7. Pinning information

7.1 Pinning

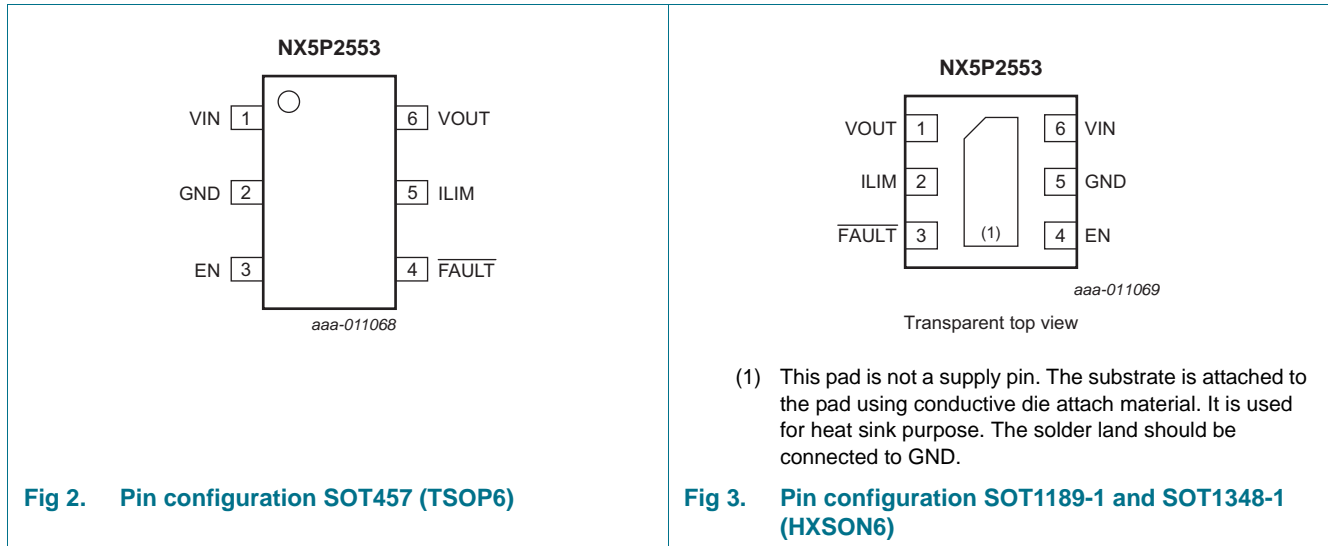

7.2 Pin description

Table 3. Pin description

Symbol	Pin		Description
	TSOP6	HXSON6	
VOUT	6	1	output voltage
ILIM	5	2	current limiter I/O
FAULT	4	3	fault condition indicator (open-drain; active LOW)
EN	3	4	enable input (active HIGH)
GND	2	5	ground (0 V)
VIN	1	6	input voltage ^[1]

[1] Connect a decoupling capacitance with a minimum value of 0.1 μF as close as possible to the input VIN.

8. Functional description

Table 4. Function table^[1]

Input EN	Switch
L	switch OFF
H	switch ON

[1] H = HIGH voltage level; L = LOW voltage level.

8.1 EN input

When EN is set to LOW, the N-channel MOSFET is disabled and the device enters a low-power mode. In low-power mode, all protection circuits are disabled and the $\overline{\text{FAULT}}$ output is set to high-impedance state. When EN is set to HIGH, all protection circuits are enabled. If no fault conditions exist, the N-channel MOSFET is enabled.

8.2 UnderVoltage LockOut (UVLO)

The UVLO circuit is active until $V_{IN} > 2.35$ V. It disables the N-channel MOSFET and switches the device back to low-power mode. It occurs irrespective of the logic level on the EN pin. Once $V_{IN} > 2.35$ V, the EN pin controls the N-channel MOSFET state. The UVLO circuit remains active in low-power mode.

8.3 ILIM

The OverCurrent Protection (OCP) circuit trigger value I_{ocp} is set using an external resistor connected to the ILIM pin as shown in [Figure 8](#). If EN is set to HIGH and the ILIM pin is grounded, the N-channel MOSFET is disabled and the $\overline{\text{FAULT}}$ output is set to LOW.

8.4 OverCurrent Protection (OCP)

Three possible overcurrent conditions can occur. They are:

- Overcurrent at start-up, $I_{SW} > I_{ocp}$ when enabling the N-channel MOSFET
- Overcurrent when enabled, $I_{SW} > I_{ocp}$ when the N-channel MOSFET is enabled
- Short-circuit when enabled, $I_{SW} > 4 \times I_{ocp}$ (typical)

8.4.1 Overcurrent at start-up

If the device senses a short or overcurrent while enabling the N-channel MOSFET, OCP is triggered. It limits the output current to I_{ocp} and after the deglitch time sets the $\overline{\text{FAULT}}$ output to LOW, as shown in [Figure 22](#). Increased power dissipation combined with the OTP may lead to temperature cycling.

8.4.2 Overcurrent when enabled

When enabled, if the device senses $I_{SW} > I_{ocp}$, the OCP is triggered. It limits the output current to I_{ocp} and after the deglitch time sets the $\overline{\text{FAULT}}$ output to LOW. Limiting the output current reduces $V_{O(VOUT)}$, as shown in [Figure 20](#) and [Figure 21](#). Increased power dissipation combined with the OTP may lead to temperature cycling.

8.4.3 Short-circuit when enabled

When enabled, if the device senses $I_{SW} > 4 \times I_{ocp}$, a short-circuit is detected. The device disables the N-channel MOSFET immediately. It then enables the N-channel MOSFET, output current is limited to I_{ocp} and after the deglitch time, the $\overline{\text{FAULT}}$ output is set to LOW as shown in [Figure 16](#) to [Figure 19](#). Increased power dissipation combined with the OTP may lead to temperature cycling.

8.5 Reverse-Voltage Protection (RVP)

If VOUT exceeds VIN by 140 mV for the deglitch time, RVP protects the device by disabling the N-channel MOSFET. When the reverse voltage condition is removed for the deglitch time, the N-channel MOSFET is enabled as shown in [Figure 14](#) and [Figure 15](#).

8.6 FAULT output

The $\overline{\text{FAULT}}$ pin is an open-drain output that requires an external pull-up resistor. If any of the protection circuits are activated, $\overline{\text{FAULT}}$ is set to LOW to indicate that a fault has occurred. It returns to the high-impedance state automatically once the fault condition is removed.

8.7 OverTemperature Protection (OTP)

If the device temperature exceeds 155 °C when EN is set HIGH and the device is not in current limit, OTP triggers. It disables the N-channel MOSFET and sets the $\overline{\text{FAULT}}$ pin to LOW. Any transition on the EN pin has no effect. Once the device temperature decreases below 125 °C, the device returns to the defined state.

If the device temperature exceeds 130 °C when EN is set HIGH and the device is in current limit, OTP triggers. It disables the N-channel MOSFET and sets the $\overline{\text{FAULT}}$ pin to LOW. Any transition on the EN pin has no effect. Once the device temperature decreases below 118 °C, the device returns to the defined state.

9. Limiting values

Table 5. Limiting values

In accordance with the Absolute Maximum Rating System (IEC 60134). Voltages are referenced to GND (ground = 0 V).

Symbol	Parameter	Conditions	Min	Max	Unit
V _I	input voltage	inputs EN and ILIM	[1] -0.35	+6.5	V
		input VIN	[2] -0.35	+6.5	V
V _O	output voltage	output $\overline{\text{FAULT}}$	[1] -0.35	V _{I(VIN)}	V
		output VOUT	[2] -0.35	+6.5	V
V _{SW}	switch voltage		[2] -6.5	+6.5	V
I _{IK}	input clamping current	input EN; V _{I(EN)} < -0.35 V	-50	-	mA
		input ILIM; V _{I(ILIM)} < -0.35 V	-50	-	mA
I _{source}	source current	input ILIM	-	1	mA
I _{OK}	output clamping current	V _O < 0 V	-50	-	mA
I _{SK}	switch clamping current	input VIN; V _{I(VIN)} < -0.35 V	-50	-	mA
		output VOUT; V _{O(VOUT)} < -0.35 V	-50	-	mA
I _{SW}	switch current	V _{SW} > -0.35 V	[3] -	1900	mA
T _{j(max)}	maximum junction temperature		-40	+150	°C
T _{stg}	storage temperature		-65	+150	°C
P _{tot}	total power dissipation	NX5P2553GV	[4] -	300	mW
		NX5P2553GU	[4] -	315	mW
		NX5P2553GU6	[4] -	340	mW

[1] If the input current rating is observed, the minimum input voltage rating may be exceeded.

[2] If the switch clamping current rating is observed, the minimum and maximum switch voltage ratings may be exceeded.

[3] Internally limited.

[4] The (absolute) maximum power dissipation depends on the junction temperature T_j. Higher power dissipation is allowed with lower ambient temperatures. The conditions to determine the specified values are T_{amb} = 85 °C and the use of a two layer PCB.

10. Recommended operating conditions

Table 6. Operating conditions

Symbol	Parameter	Conditions	Min	Max	Unit
V _I	input voltage	input VIN	2.5	5.5	V
		input EN	0	5.5	V
I _{SW}	switch current	T _j = -40 °C to +125 °C	0	1.2	A
		T _j = -40 °C to +105 °C	0	1.5	A
I _{O(sink)}	output sink current	output $\overline{\text{FAULT}}$	-10	-	mA
R _{ILIM}	current limit resistance	input ILIM [1]	15	232	kΩ
C _{dec}	decoupling capacitance	VIN and VOUT to GND	0.1	-	μF
T _{amb}	ambient temperature		-40	+85	°C
T _j	junction temperature	I _{SW} < 1.2 A	-40	+125	°C
		I _{SW} < 1.5 A	-40	+105	°C

[1] Current-limit threshold resistor range from ILIM to GND.

11. Thermal characteristics

Table 7. Thermal characteristics

Symbol	Parameter	Conditions	Typ	Unit
R _{th(j-a)}	thermal resistance from junction to ambient	NX5P2553GV [1]	133	K/W
		NX5P2553GU [1]	105	K/W
		NX5P2553GU6 [1]	93	K/W

[1] R_{th(j-a)} is dependent upon board layout. To minimize R_{th(j-a)}, ensure that all pins have a solid connection to larger copper layer areas. In multi-layer PCBs, the second layer should be used to create a large heat spreader area below the device. Avoid using solder-stop varnish under the device.

12. Static characteristics

Table 8. Static characteristics

At recommended operating conditions; V_{I(VIN)} = V_{I(EN)} and R_{FAULT} = 10 kΩ unless otherwise specified; voltages are referenced to GND (ground = 0 V); see [Figure 4](#), [Figure 5](#), [Figure 6](#), and [Figure 11](#).

Symbol	Parameter	Conditions	Min	Typ ^[1]	Max	Unit
V _{IH}	HIGH-level input voltage	EN input; V _{I(VIN)} = 2.5 V to 5.5 V	1.3	-	-	V
V _{IL}	LOW-level input voltage	EN input; V _{I(VIN)} = 2.5 V to 5.5 V	-	-	0.56	V
I _{LI}	input leakage current	EN input; V _{I(VIN)} = 2.5 V to 5.5 V; V _{I(EN)} = 0 V or 5.5 V	-	-	±0.5	μA
I _{VIN}	supply current	VOUT open; V _{I(VIN)} = 5.5 V				
		EN = GND (low-power mode)	-	0.3	1	μA
		EN = V _{I(VIN)} ; R _{ext} = 20 kΩ	-	160	225	μA
		EN = V _{I(VIN)} ; R _{ext} = 210 kΩ	-	135	200	μA
I _{OFF}	power-off leakage current	VOUT; T _j = 25 °C; V _{I(VIN)} = 0 V; V _{O(VOUT)} = 5.5 V	-	0.1	1	μA

Table 8. Static characteristics ...continued

At recommended operating conditions; $V_{I(VIN)} = V_{I(EN)}$ and $R_{FAULT} = 10\text{ k}\Omega$ unless otherwise specified; voltages are referenced to GND (ground = 0 V); see [Figure 4](#), [Figure 5](#), [Figure 6](#), and [Figure 11](#).

Symbol	Parameter	Conditions	Min	Typ ^[1]	Max	Unit
$I_{S(OFF)}$	OFF-state leakage current	V_{OUT} ; $T_j = 25\text{ }^\circ\text{C}$; $V_{I(VIN)} = 5.5\text{ V}$; $V_{O(VOUT)} = 0\text{ V to }5.5\text{ V}$	-	± 0.1	± 1	μA
V_{trip}	trip level voltage	RVP; $V_{I(VIN)} = 2.5\text{ V to }5.5\text{ V}$	80	140	195	mV
V_{UVLO}	undervoltage lockout voltage	VIN input	-	2.35	2.45	V
$V_{hys(UVLO)}$	undervoltage lockout hysteresis voltage		-	25	-	mV
V_{OL}	LOW-level output voltage	\overline{FAULT} ; $V_{I(VIN)} = 2.5\text{ V to }5.5\text{ V}$; $I_O = 1\text{ mA}$	-	-	180	mV
I_{OZ}	OFF-state output current	\overline{FAULT} ; $V_{I(VIN)} = 5.5\text{ V}$; $V_{O(\overline{FAULT})} = 5.5\text{ V}$	-	-	1	μA

[1] Typical values are measured at $T_j = 25\text{ }^\circ\text{C}$.

12.1 Graphs

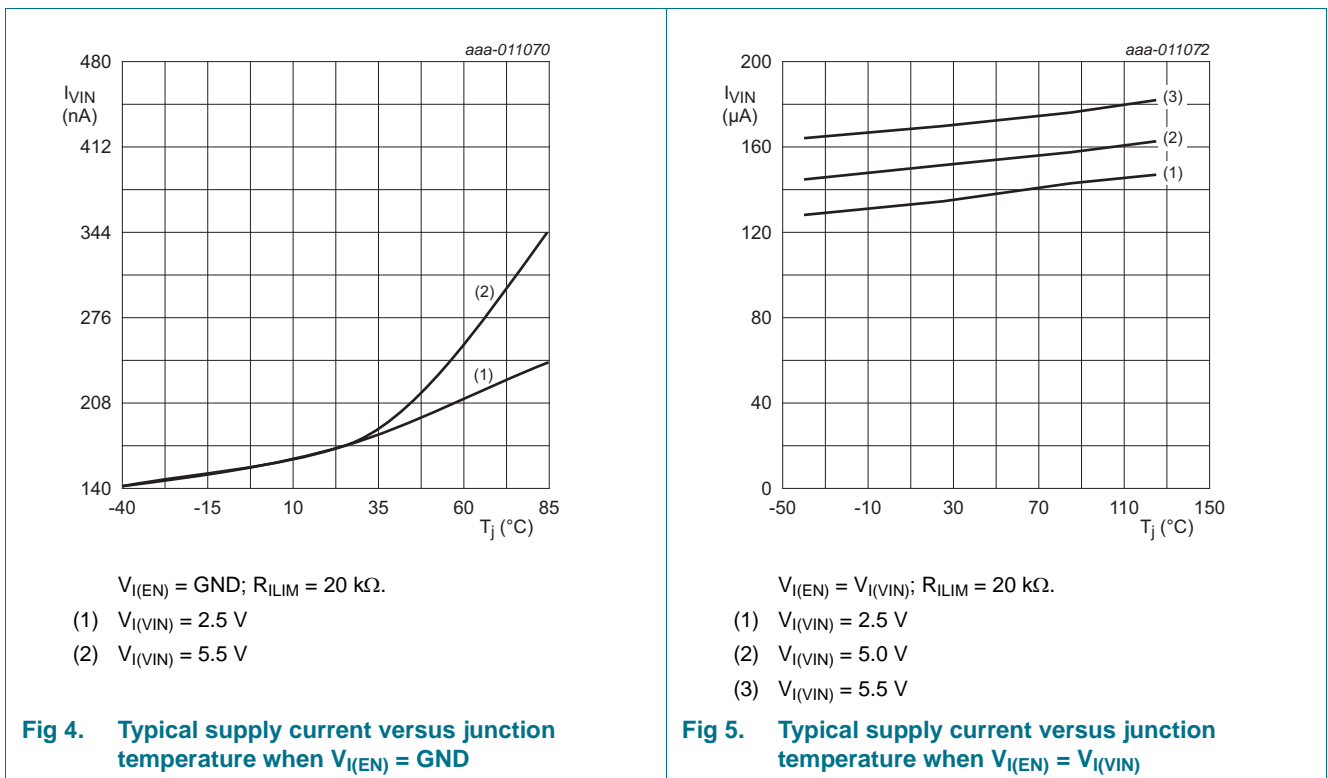

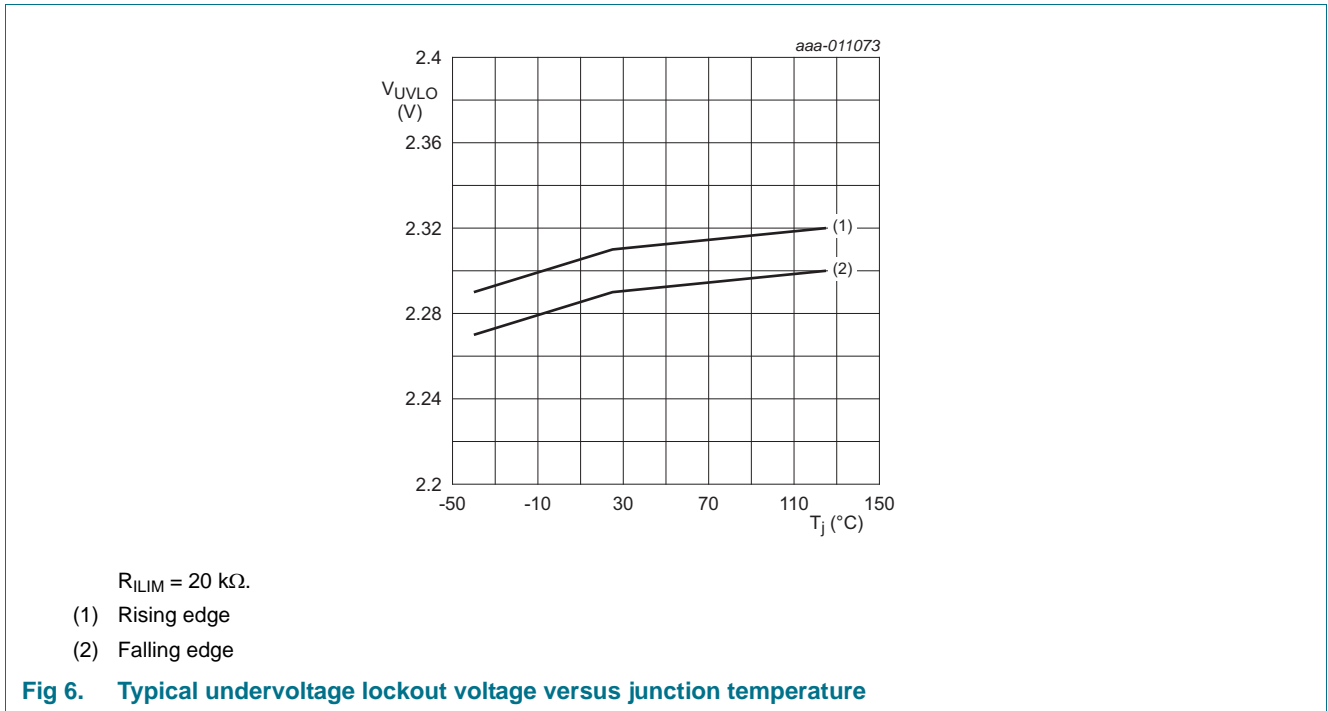

12.2 ON resistance

Table 9. ON resistance

$V_{I(VIN)} = V_{I(EN)}$ and $R_{FAULT} = 10 \text{ k}\Omega$ unless otherwise specified; voltages are referenced to GND (ground = 0 V); see [Figure 7](#) and [Figure 11](#).

Symbol	Parameter	Conditions	Min	Typ	Max	Unit
R _{ON}	ON resistance	$V_{I(VIN)} = 2.5 \text{ V to } 5.5 \text{ V}$				
		NX5P2553GU; $T_j = 25 \text{ }^\circ\text{C}$	-	100	115	mΩ
		NX5P2553GU; $T_j = -40 \text{ }^\circ\text{C to } +105 \text{ }^\circ\text{C}$	-	-	140	mΩ
		NX5P2553GU; $T_j = -40 \text{ }^\circ\text{C to } +125 \text{ }^\circ\text{C}$	-	-	150	mΩ
		NX5P2553GU6; $T_j = 25 \text{ }^\circ\text{C}$	-	115	125	mΩ
		NX5P2553GU6; $T_j = -40 \text{ }^\circ\text{C to } +105 \text{ }^\circ\text{C}$	-	-	150	mΩ
		NX5P2553GU6; $T_j = -40 \text{ }^\circ\text{C to } +125 \text{ }^\circ\text{C}$	-	-	160	mΩ
		NX5P2553GV; $T_j = 25 \text{ }^\circ\text{C}$	-	95	100	mΩ
NX5P2553GV; $T_j = -40 \text{ }^\circ\text{C to } +125 \text{ }^\circ\text{C}$	-	-	135	mΩ		

12.3 ON resistance graph

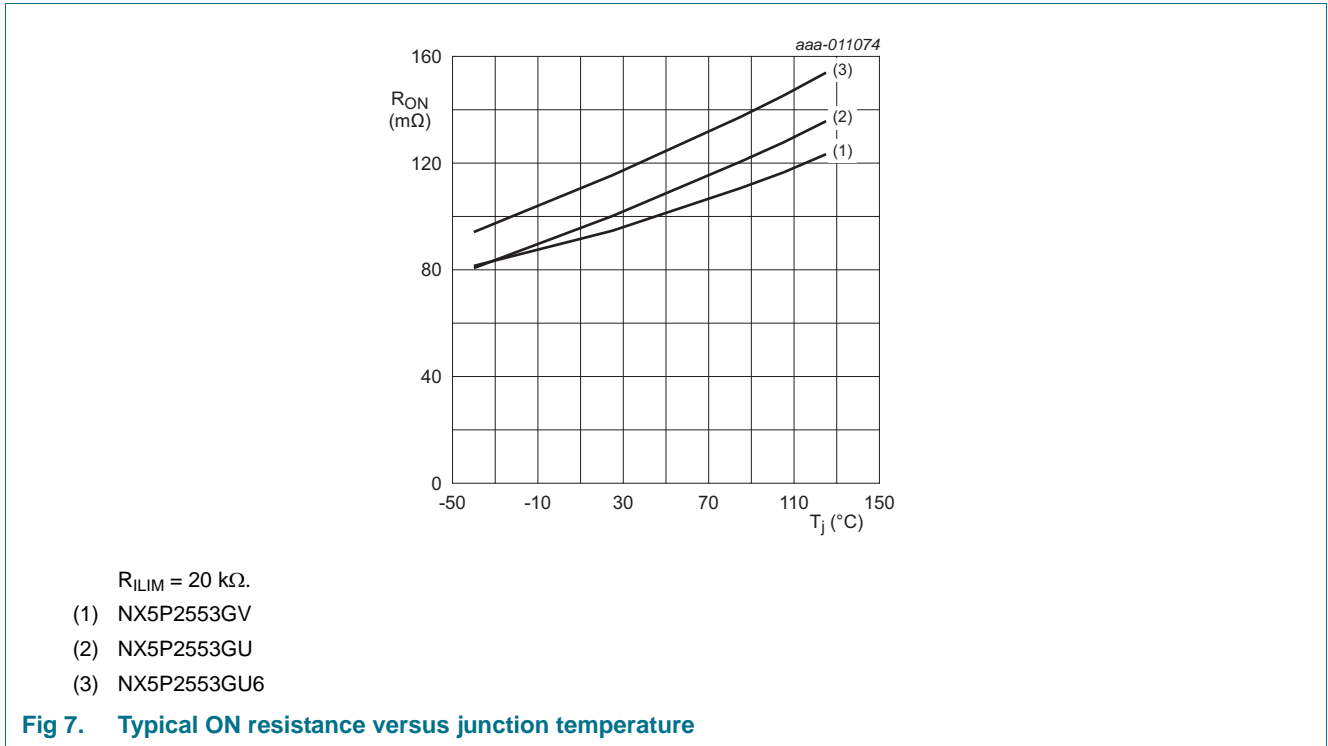

12.4 Current limit

Table 10. Characteristics

$V_{I(VIN)} = V_{I(EN)}$ and $R_{FAULT} = 10\text{ k}\Omega$ unless otherwise specified; voltages are referenced to GND (ground = 0 V); see [Figure 8](#), [Figure 11](#), [Figure 23](#) and [Figure 24](#).

Symbol	Parameter	Conditions	Min	Typ ^[1]	Max	Unit
I_{ocp}	overcurrent protection current	$V_{I(VIN)} = 2.5\text{ V to }5.5\text{ V}$				
		$R_{ILIM} = 15\text{ k}\Omega; T_j = -40\text{ }^\circ\text{C to }+105\text{ }^\circ\text{C}$	1650	1780	1900	mA
		$R_{ILIM} = 20\text{ k}\Omega; T_j = 25\text{ }^\circ\text{C}$	1230	1320	1430	mA
		$R_{ILIM} = 20\text{ k}\Omega; T_j = -40\text{ }^\circ\text{C to }+125\text{ }^\circ\text{C}$	1215	1320	1450	mA
		$R_{ILIM} = 49.9\text{ k}\Omega; T_j = 25\text{ }^\circ\text{C}$	480	530	560	mA
		$R_{ILIM} = 49.9\text{ k}\Omega; T_j = -40\text{ }^\circ\text{C to }+125\text{ }^\circ\text{C}$	465	530	575	mA
		$R_{ILIM} = 210\text{ k}\Omega; T_j = -40\text{ }^\circ\text{C to }+125\text{ }^\circ\text{C}$	95	140	180	mA
		ILIM shorted to VIN; $T_j = -40\text{ }^\circ\text{C to }+125\text{ }^\circ\text{C}$	50	85	115	mA

[1] Typical values are measured at $T_j = 25\text{ }^\circ\text{C}$.

12.5 Current limit graph

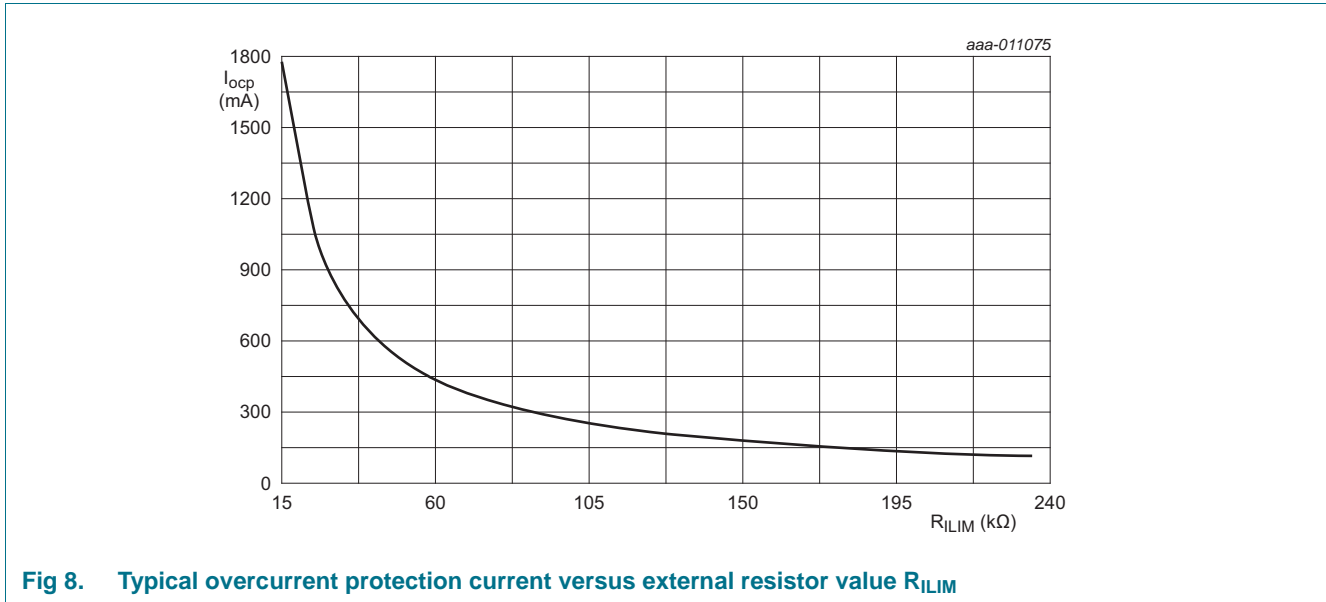

Fig 8. Typical overcurrent protection current versus external resistor value R_{ILIM}

12.6 Thermal shutdown

Table 11. Thermal shutdown

V_{I(VIN)} = V_{I(EN)} and R_{FAULT} = 10 kΩ unless otherwise specified; voltages are referenced to GND (ground = 0 V); see Figure 11.

Symbol	Parameter	Conditions	Min	Typ	Max	Unit
T _{th(ots)}	overtemperature shutdown threshold temperature	in normal mode	155	-	-	°C
		in current limit mode	130	-	-	°C
T _{th(ots)hys}	overtemperature shutdown threshold temperature hysteresis	in normal mode	-	30	-	°C
		in current limit mode	-	12	-	°C

13. Dynamic characteristics

Table 12. Characteristics

At recommended operating conditions; V_{I(VIN)} = V_{I(EN)} and R_{FAULT} = 10 kΩ unless otherwise specified; voltages are referenced to GND (ground = 0 V); see Figure 9, Figure 10, Figure 11, Figure 12, Figure 13, Figure 14, Figure 15, Figure 16, and Figure 22.

Symbol	Parameter	Conditions	Min	Typ ^[1]	Max	Unit
t _{TLH}	LOW to HIGH output transition time	VOUT; V _{I(VIN)} = 5.5 V	-	1.2	1.5	ms
		VOUT; V _{I(VIN)} = 2.5 V	-	0.5	1.0	ms
t _{THL}	HIGH to LOW output transition time	VOUT; V _{I(VIN)} = 5.5 V	0.2	-	0.5	ms
		VOUT; V _{I(VIN)} = 2.5 V	0.2	-	0.5	ms
t _{en}	enable time	EN to VOUT; V _{I(VIN)} = 5.5 V ^[2]	-	-	3	ms
t _{dis}	disable time	EN to VOUT; V _{I(VIN)} = 5.5 V ^[3]	-	-	3	ms

Table 12. Characteristics ...continued

At recommended operating conditions; $V_{I(VIN)} = V_{I(EN)}$ and $R_{FAULT} = 10\text{ k}\Omega$ unless otherwise specified; voltages are referenced to GND (ground = 0 V); see [Figure 9](#), [Figure 10](#), [Figure 11](#), [Figure 12](#), [Figure 13](#), [Figure 14](#), [Figure 15](#), [Figure 16](#), and [Figure 22](#).

Symbol	Parameter	Conditions	Min	Typ ^[1]	Max	Unit
t_{off}	turn-off time	short-circuit; $V_{I(VIN)} = 5\text{ V}$	-	2	-	μs
		RVP; $V_{I(VIN)} = 5\text{ V}$	3	5	7	ms
t_{degl}	deglitch time	$\overline{\text{FAULT}}$; OCP; $V_{I(VIN)} = 5\text{ V}$	5	8.7	12	ms
		$\overline{\text{FAULT}}$; RVP; $V_{I(VIN)} = 5\text{ V}$	2	4.4	6	ms

[1] Typical values are measured at $T_j = 25\text{ }^\circ\text{C}$.

[2] t_{en} is the same as t_{pZH} .

[3] t_{dis} is the same as t_{pHZ} .

13.1 Waveform and test circuits

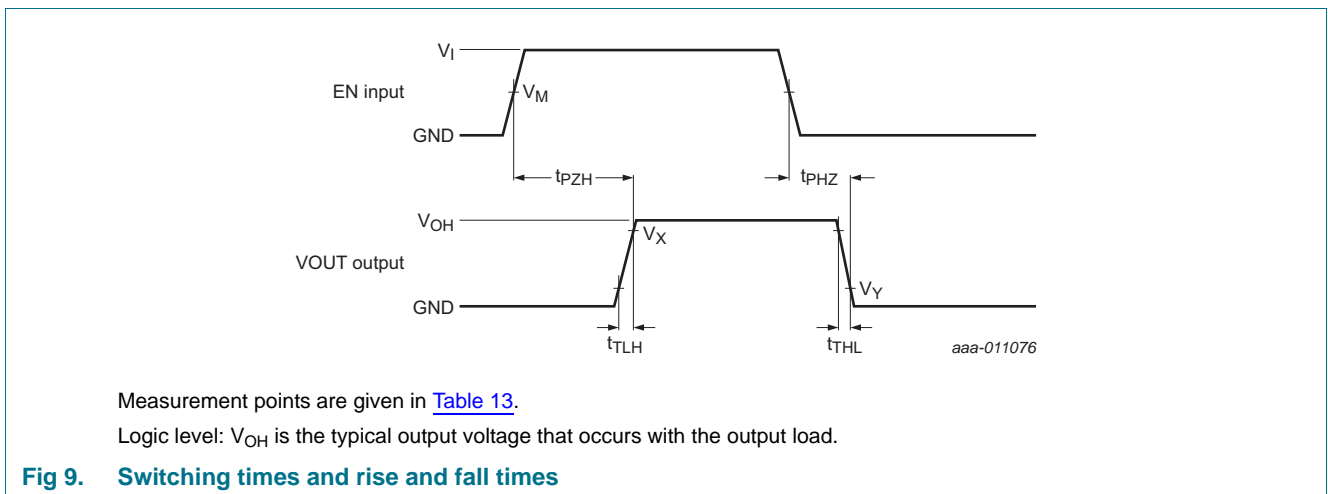
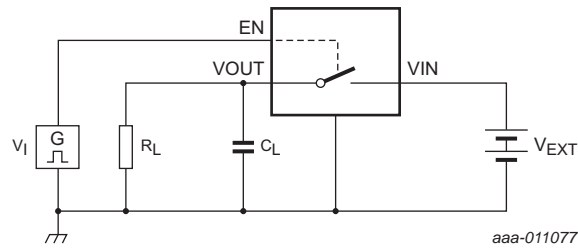

Table 13. Measurement points

Supply voltage	EN input	Output	
$V_{I(VIN)}$	V_M	V_X	V_Y
2.5 V	$0.5 \times V_{I(EN)}$	$0.9 \times V_{OH}$	$0.1 \times V_{OH}$
5.5 V	$0.5 \times V_{I(EN)}$	$0.9 \times V_{OH}$	$0.1 \times V_{OH}$



Test data is given in [Table 14](#).

Definitions test circuit:

R_L = Load resistance.

C_L = Load capacitance including jig and probe capacitance.

V_{EXT} = External voltage for measuring switching times.

Fig 10. Test circuit for measuring switching times

Table 14. Test data

Supply voltage	EN input	Load	
V_{EXT}	$V_{I(EN)}$	C_L	R_L
2.5 V	0 V to $V_{I(VIN)}$	1 μ F	100 Ω
5.5 V	0 V to $V_{I(VIN)}$	1 μ F	100 Ω

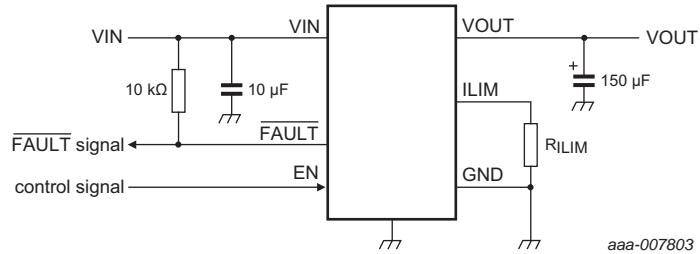
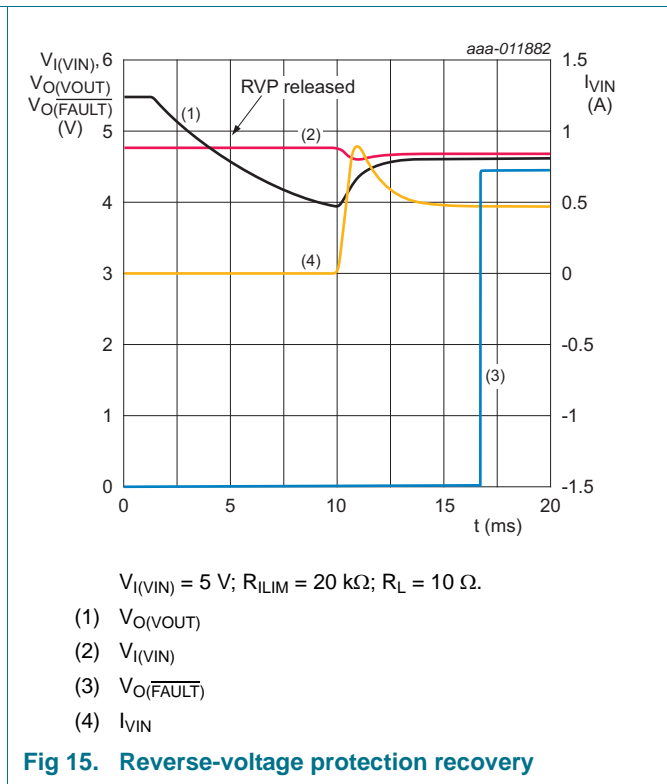
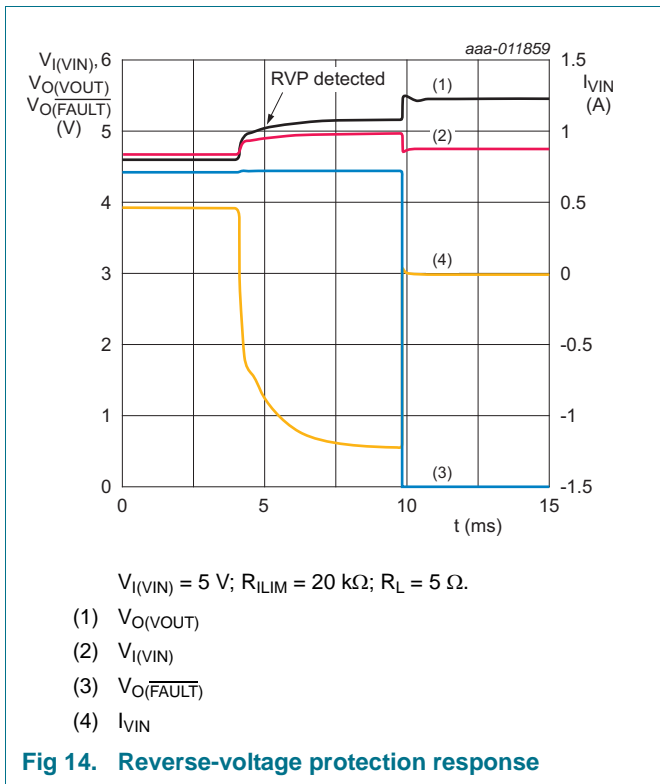
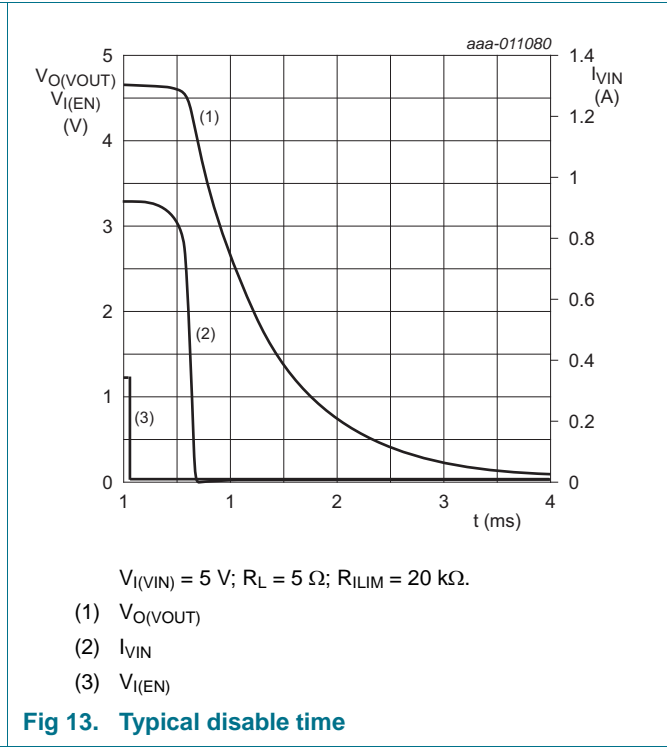
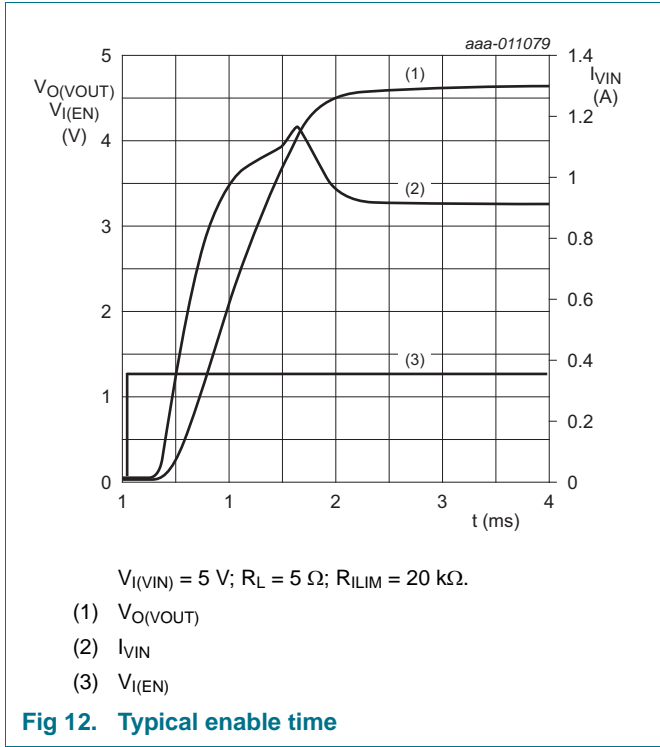
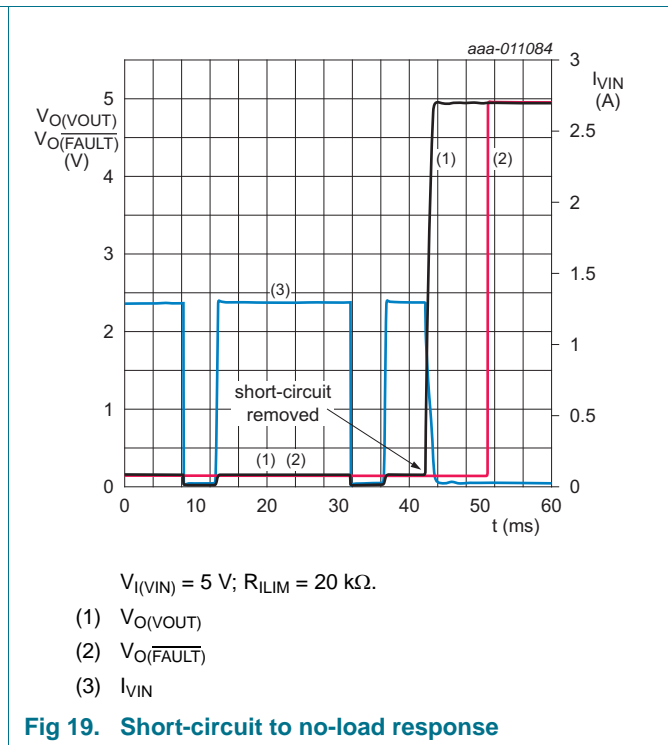
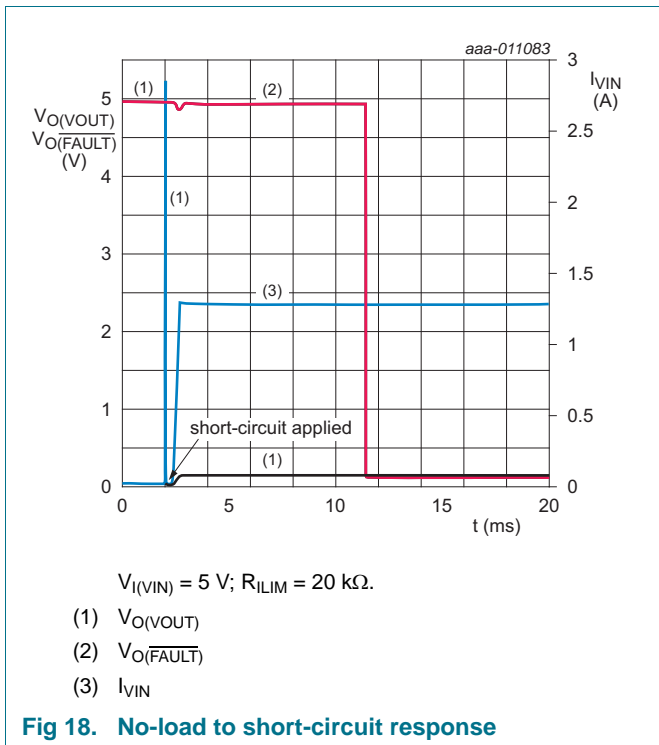
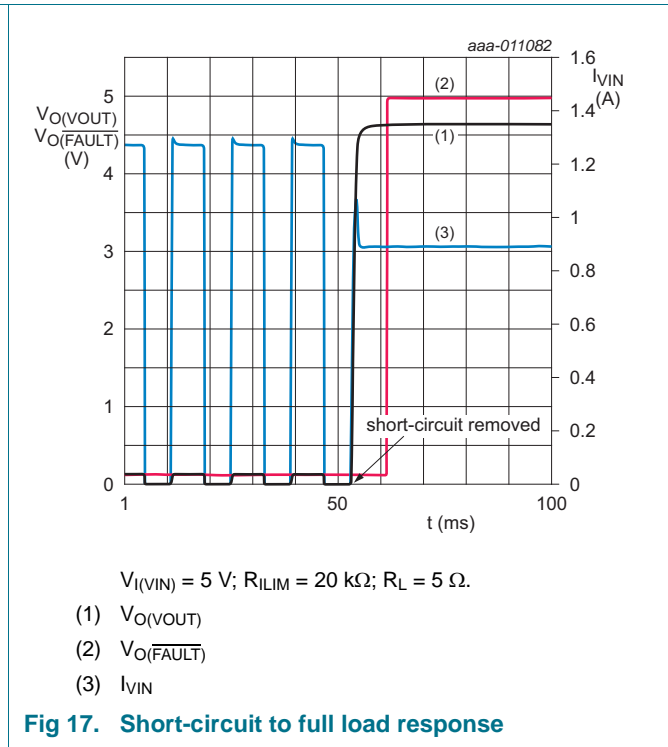
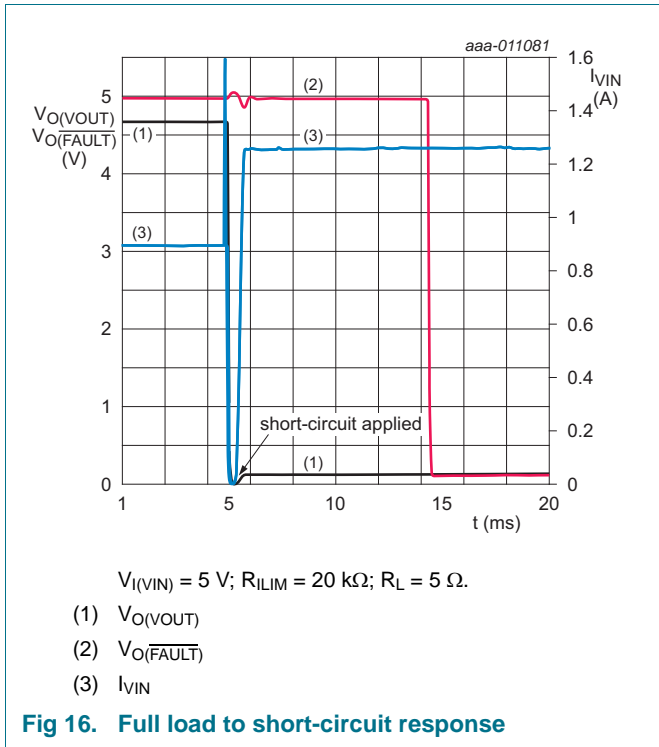
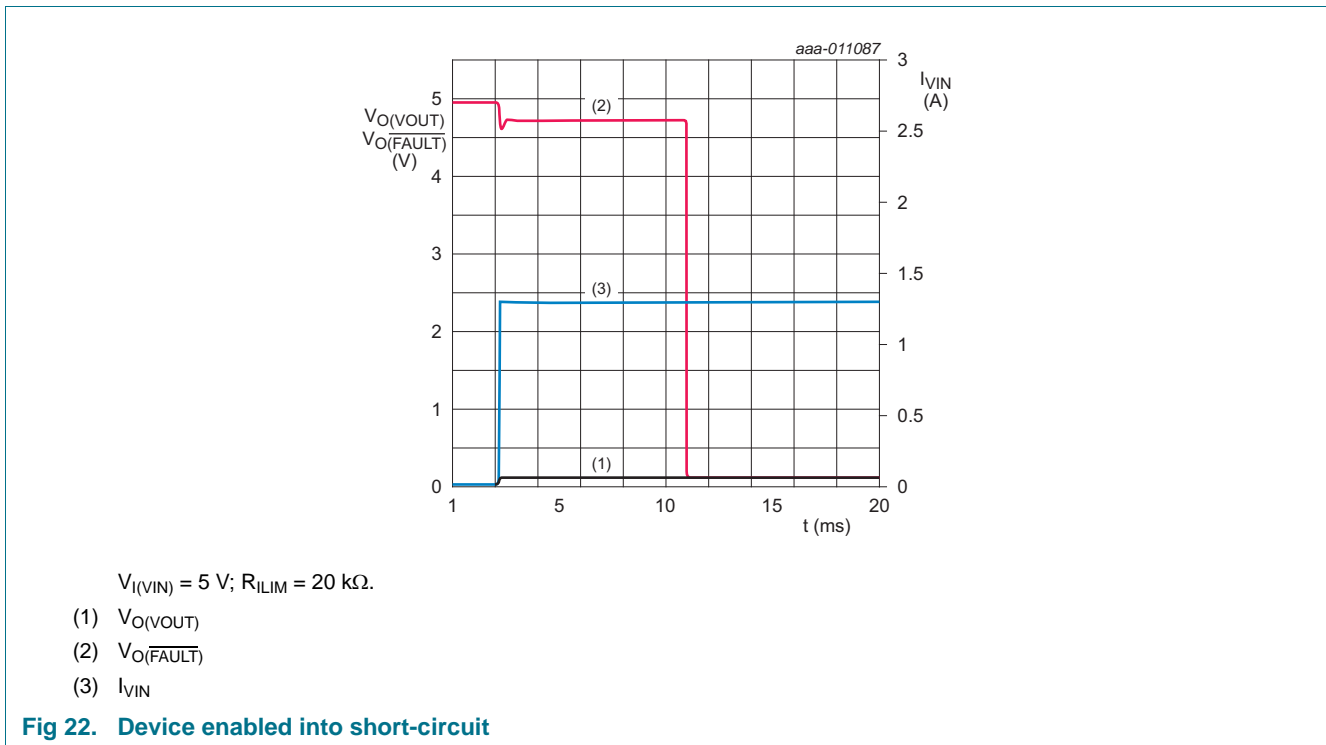
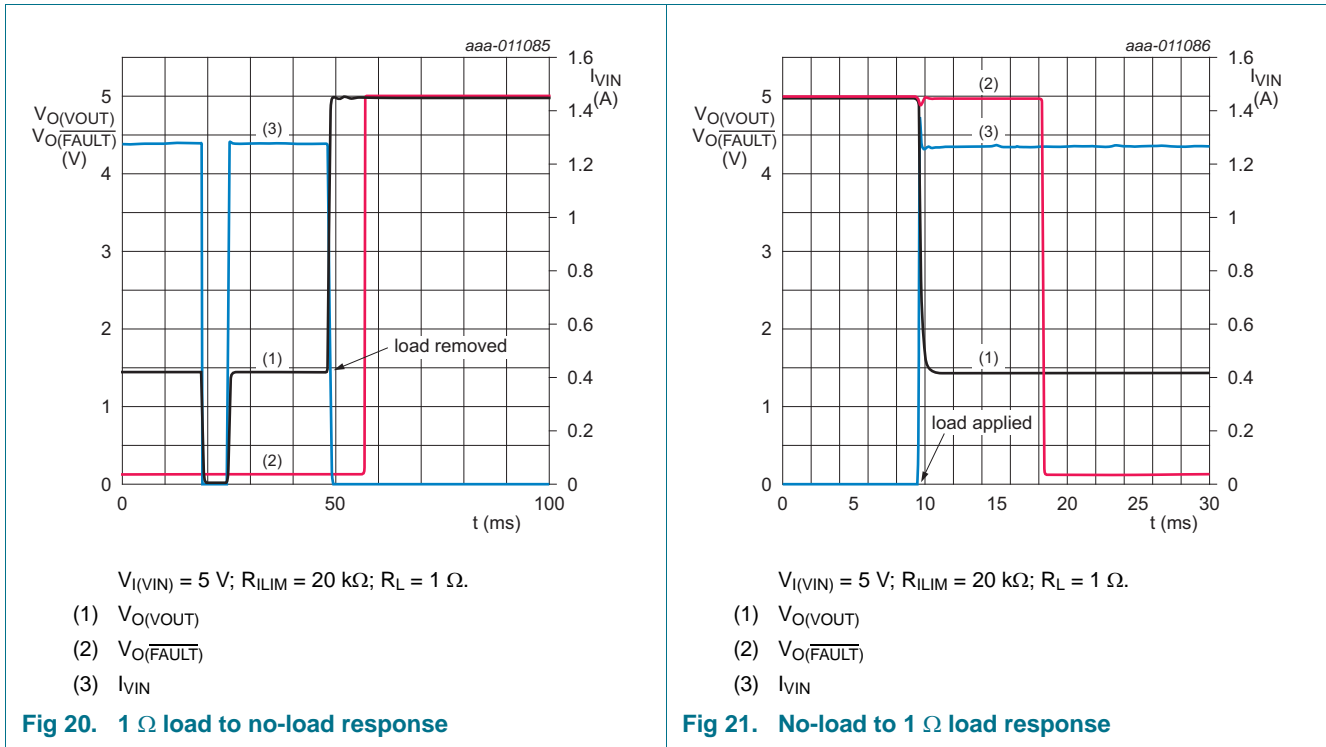
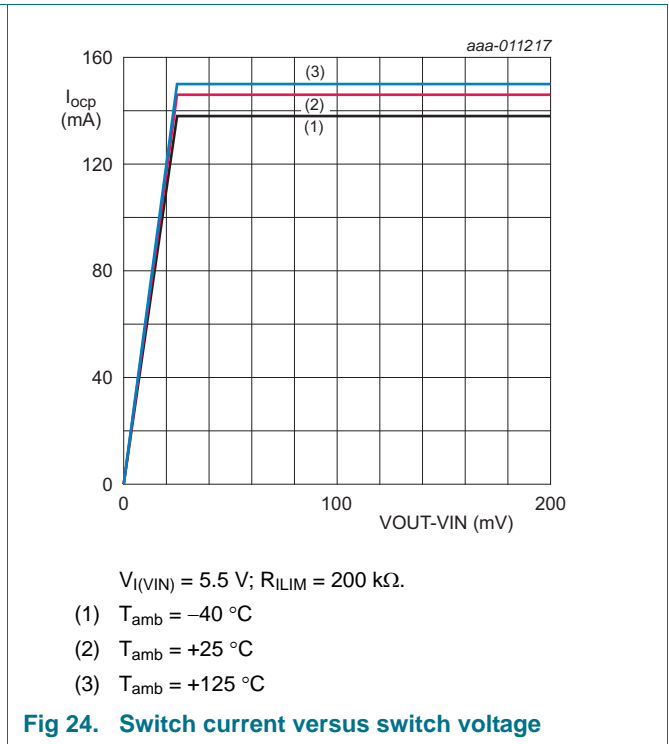
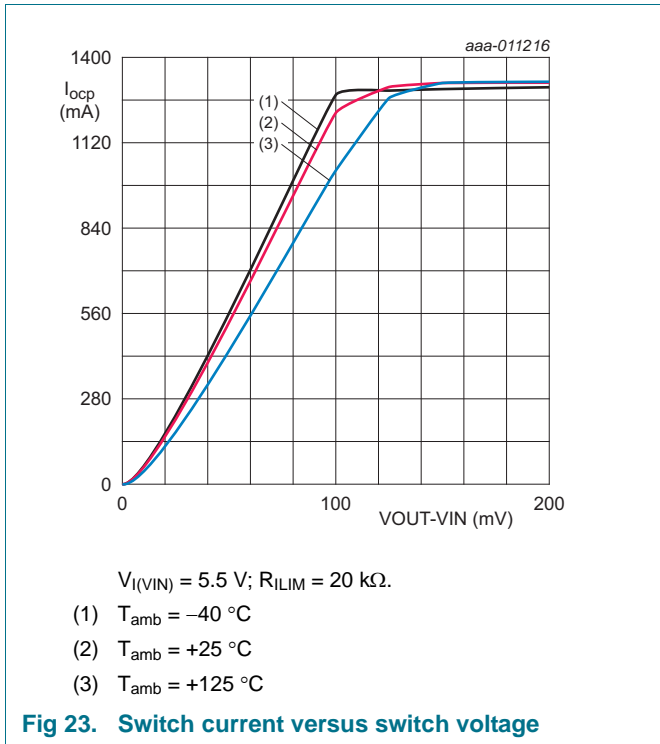

Fig 11. Typical characteristics reference schematic









14. Application information

14.1 Application diagram

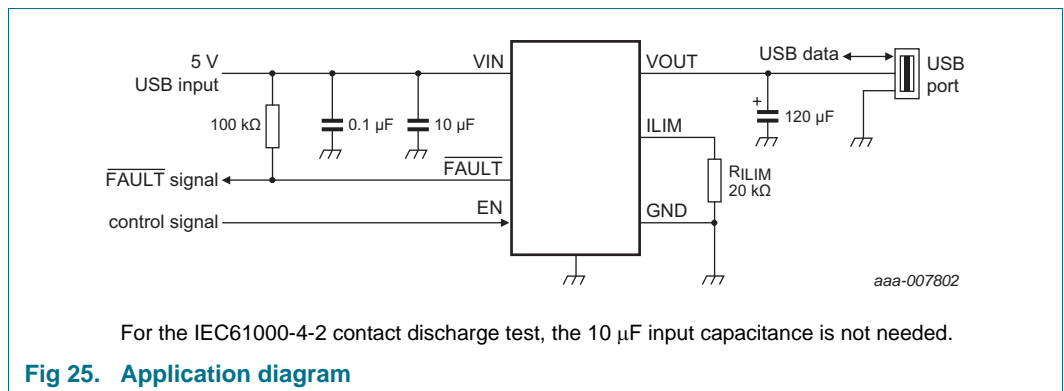

14.2 Best practices

In order to avoid product damage, the device should always operate within the boundaries given in [Section 9](#). However, in applications with high switching currents, these limits might be violated during transients even when the static values are well within the limiting values. The device includes soft-start which limits in-rush current when enabling the N-channel MOSFET. This feature does not limit current transients due to load change when the N-channel MOSFET is already enabled.

The following aspects can be taken as guideline:

- Widen the circuit board traces between:
 - Power supply and VIN input
 - VOUT output and load connection (USB plug)
 - Load GND (USB plug) and power supply GND as much as possible. Define a Kelvin point in the GND line, close to the product and have the device GND connected to it.
- Use combination of larger and smaller value capacitors with low ESR at the VIN input and the VOUT output. Ensure that wires to the VIN input, VOUT output and the Kelvin point are short. Wires behave like coils. Transient currents (e.g. as a result of a short) may lead to high positive or negative inductance voltages. The carefully routed high-current path and the short wired capacitors at the VIN input and the VOUT output keeps these voltages away from the product.
- Load transients affect the supply of the application. Load transients result from the switch enable and disable process as well as load jumps (application of or removal of load). The supply might react to load transients with voltage jumps that exceed the Limiting values. If such voltage jumps are larger, the capacitors at the VIN input and the VOUT output might not be able to filter them. A strong 6 V Zener diode between VIN and GND might be considered. Improving the design of the supply is a better solution.

15. Package outline

Plastic surface-mounted package (TSOP6); 6 leads

SOT457

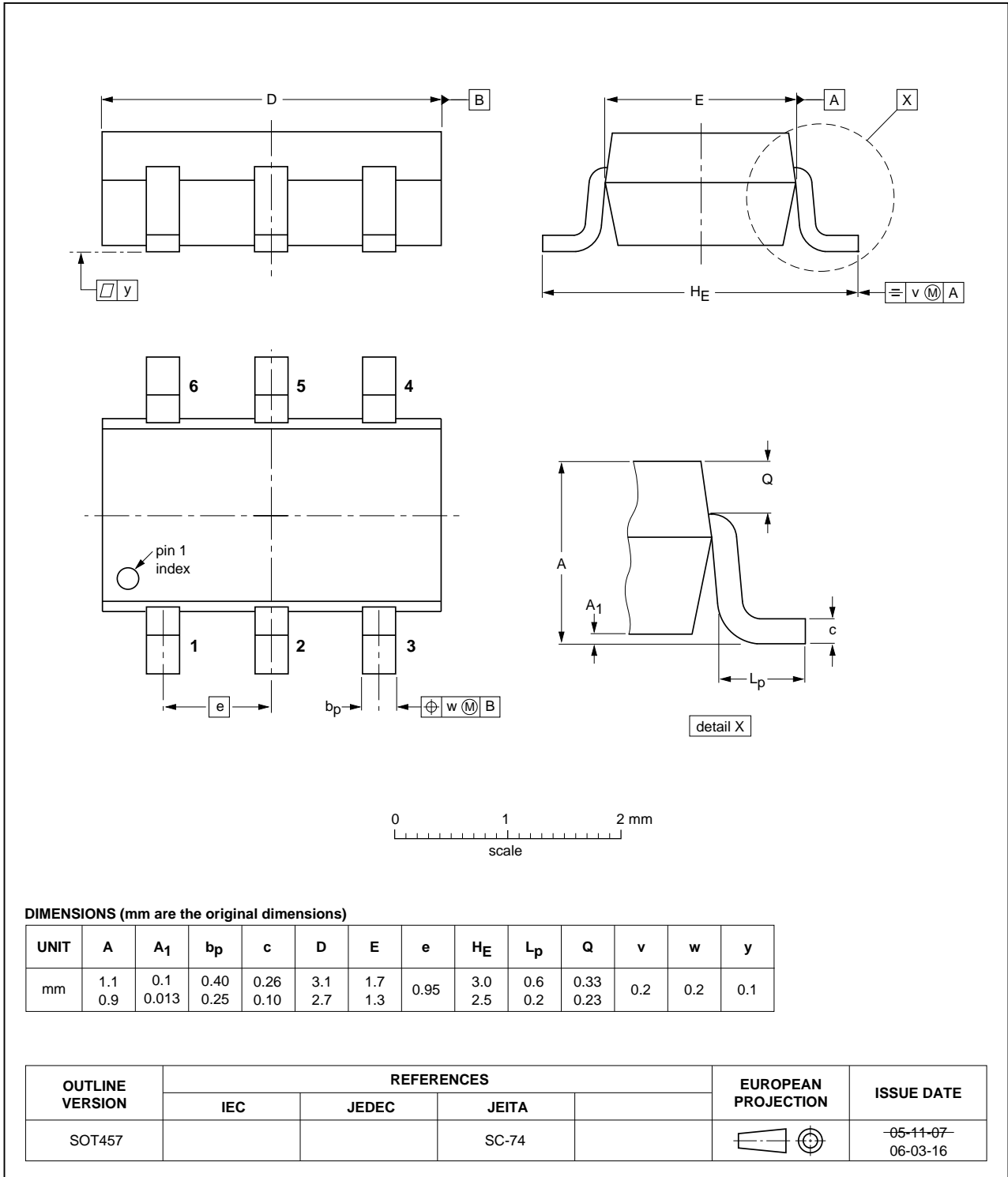

Fig 26. Package outline SOT457 (TSOP6)

HXSON6: plastic, thermal enhanced extremely thin small outline package; no leads;
6 terminals; body 1.6 x 1.6 x 0.5 mm

SOT1189-1

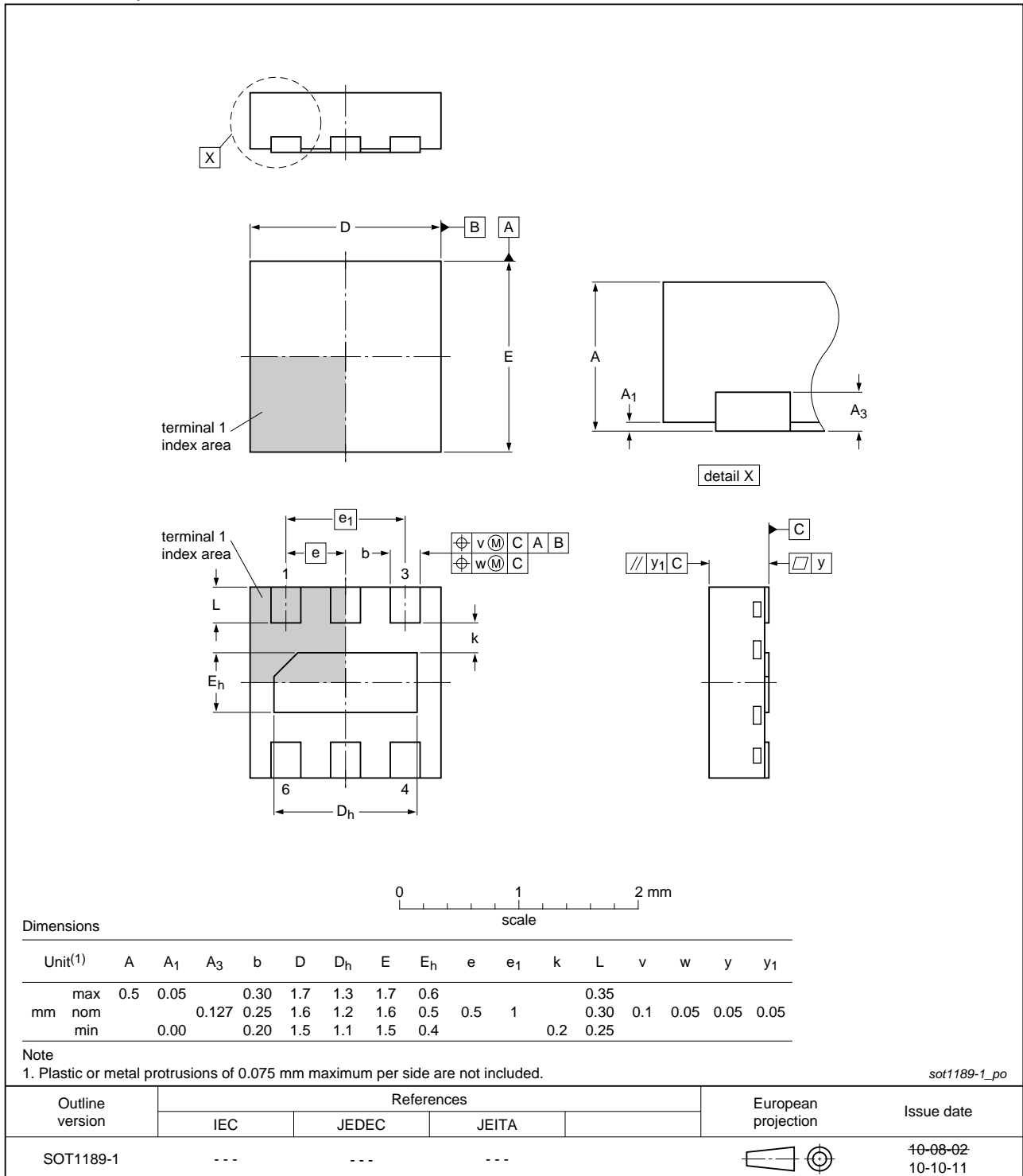

Fig 27. Package outline SOT1189-1 (HXSON6)

HXSON6: plastic, thermal enhanced extremely thin small outline package; no leads;
6 terminals; body 2.0 x 2.0 x 0.5 mm

SOT1348-1

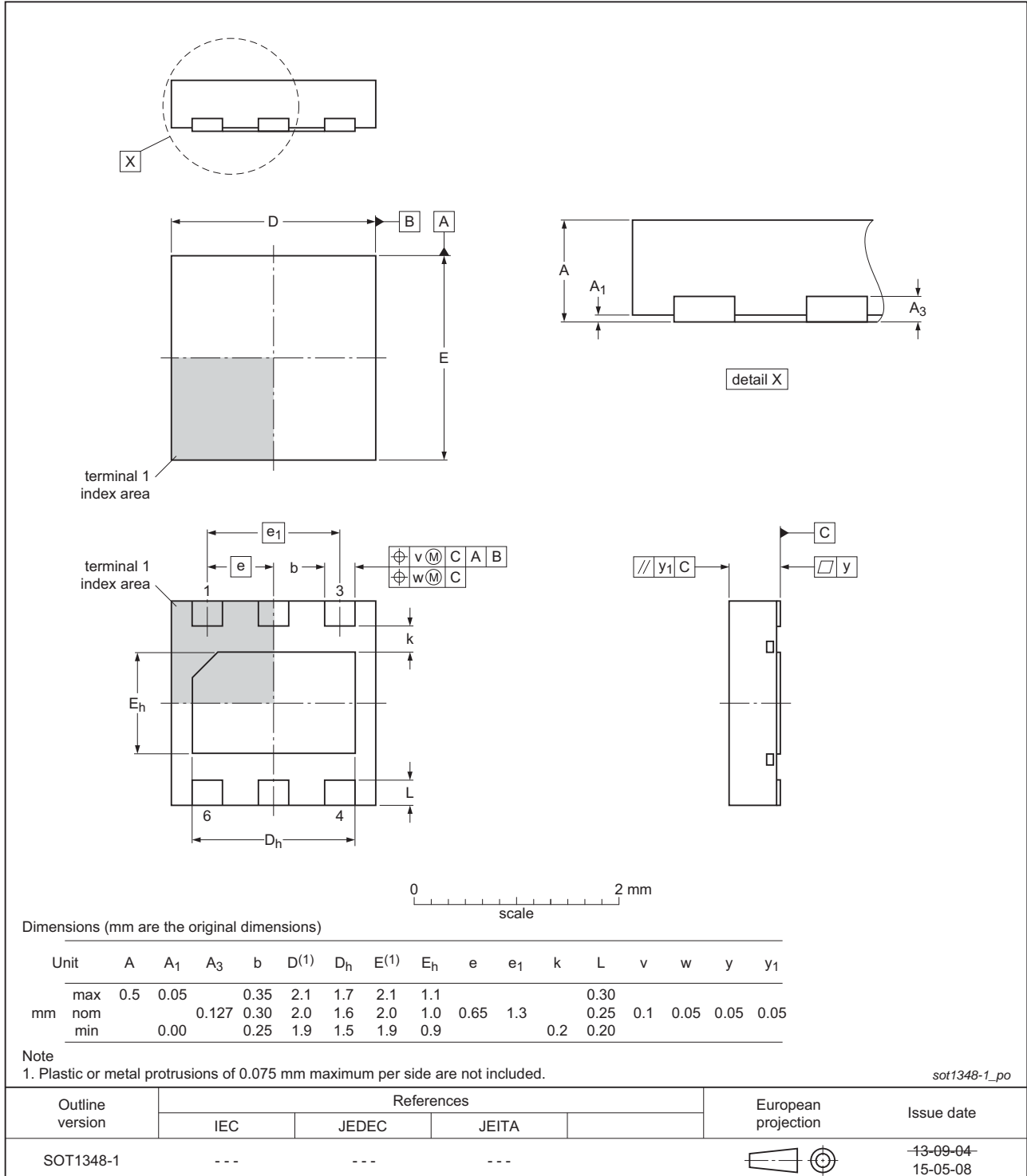

Fig 28. Package outline SOT1348-1 (HXSON6)

16. Abbreviations

Table 15. Abbreviations

Acronym	Description
CDM	Charged Device Model
ESD	ElectroStatic Discharge
ESR	Equivalent Series Resistance
HBM	Human Body Model
MOSFET	Metal-Oxide Semiconductor Field-Effect Transistor
OCP	OverCurrent Protection
OTP	OverTemperature Protection
PCB	Printed-Circuit Board
RVP	Reverse-Voltage Protection
USB	Universal Serial Bus
UVLO	UnderVoltage LockOut
VoIP	Voice over Internet Protocol

17. Revision history

Table 16. Revision history

Document ID	Release date	Data sheet status	Change notice	Supersedes
NX5P2553 v.1	20150706	Product data sheet	-	-

18. Legal information

18.1 Data sheet status

Document status ^{[1][2]}	Product status ^[3]	Definition
Objective [short] data sheet	Development	This document contains data from the objective specification for product development.
Preliminary [short] data sheet	Qualification	This document contains data from the preliminary specification.
Product [short] data sheet	Production	This document contains the product specification.

[1] Please consult the most recently issued document before initiating or completing a design.

[2] The term 'short data sheet' is explained in section "Definitions".

[3] The product status of device(s) described in this document may have changed since this document was published and may differ in case of multiple devices. The latest product status information is available on the Internet at URL <http://www.nxp.com>.

18.2 Definitions

Draft — The document is a draft version only. The content is still under internal review and subject to formal approval, which may result in modifications or additions. NXP Semiconductors does not give any representations or warranties as to the accuracy or completeness of information included herein and shall have no liability for the consequences of use of such information.

Short data sheet — A short data sheet is an extract from a full data sheet with the same product type number(s) and title. A short data sheet is intended for quick reference only and should not be relied upon to contain detailed and full information. For detailed and full information see the relevant full data sheet, which is available on request via the local NXP Semiconductors sales office. In case of any inconsistency or conflict with the short data sheet, the full data sheet shall prevail.

Product specification — The information and data provided in a Product data sheet shall define the specification of the product as agreed between NXP Semiconductors and its customer, unless NXP Semiconductors and customer have explicitly agreed otherwise in writing. In no event however, shall an agreement be valid in which the NXP Semiconductors product is deemed to offer functions and qualities beyond those described in the Product data sheet.

18.3 Disclaimers

Limited warranty and liability — Information in this document is believed to be accurate and reliable. However, NXP Semiconductors does not give any representations or warranties, expressed or implied, as to the accuracy or completeness of such information and shall have no liability for the consequences of use of such information. NXP Semiconductors takes no responsibility for the content in this document if provided by an information source outside of NXP Semiconductors.

In no event shall NXP Semiconductors be liable for any indirect, incidental, punitive, special or consequential damages (including - without limitation - lost profits, lost savings, business interruption, costs related to the removal or replacement of any products or rework charges) whether or not such damages are based on tort (including negligence), warranty, breach of contract or any other legal theory.

Notwithstanding any damages that customer might incur for any reason whatsoever, NXP Semiconductors' aggregate and cumulative liability towards customer for the products described herein shall be limited in accordance with the *Terms and conditions of commercial sale* of NXP Semiconductors.

Right to make changes — NXP Semiconductors reserves the right to make changes to information published in this document, including without limitation specifications and product descriptions, at any time and without notice. This document supersedes and replaces all information supplied prior to the publication hereof.

Suitability for use — NXP Semiconductors products are not designed, authorized or warranted to be suitable for use in life support, life-critical or safety-critical systems or equipment, nor in applications where failure or malfunction of an NXP Semiconductors product can reasonably be expected to result in personal injury, death or severe property or environmental damage. NXP Semiconductors and its suppliers accept no liability for inclusion and/or use of NXP Semiconductors products in such equipment or applications and therefore such inclusion and/or use is at the customer's own risk.

Applications — Applications that are described herein for any of these products are for illustrative purposes only. NXP Semiconductors makes no representation or warranty that such applications will be suitable for the specified use without further testing or modification.

Customers are responsible for the design and operation of their applications and products using NXP Semiconductors products, and NXP Semiconductors accepts no liability for any assistance with applications or customer product design. It is customer's sole responsibility to determine whether the NXP Semiconductors product is suitable and fit for the customer's applications and products planned, as well as for the planned application and use of customer's third party customer(s). Customers should provide appropriate design and operating safeguards to minimize the risks associated with their applications and products.

NXP Semiconductors does not accept any liability related to any default, damage, costs or problem which is based on any weakness or default in the customer's applications or products, or the application or use by customer's third party customer(s). Customer is responsible for doing all necessary testing for the customer's applications and products using NXP Semiconductors products in order to avoid a default of the applications and the products or of the application or use by customer's third party customer(s). NXP does not accept any liability in this respect.

Limiting values — Stress above one or more limiting values (as defined in the Absolute Maximum Ratings System of IEC 60134) will cause permanent damage to the device. Limiting values are stress ratings only and (proper) operation of the device at these or any other conditions above those given in the Recommended operating conditions section (if present) or the Characteristics sections of this document is not warranted. Constant or repeated exposure to limiting values will permanently and irreversibly affect the quality and reliability of the device.

Terms and conditions of commercial sale — NXP Semiconductors products are sold subject to the general terms and conditions of commercial sale, as published at <http://www.nxp.com/profile/terms>, unless otherwise agreed in a valid written individual agreement. In case an individual agreement is concluded only the terms and conditions of the respective agreement shall apply. NXP Semiconductors hereby expressly objects to applying the customer's general terms and conditions with regard to the purchase of NXP Semiconductors products by customer.

No offer to sell or license — Nothing in this document may be interpreted or construed as an offer to sell products that is open for acceptance or the grant, conveyance or implication of any license under any copyrights, patents or other industrial or intellectual property rights.

Export control — This document as well as the item(s) described herein may be subject to export control regulations. Export might require a prior authorization from competent authorities.

Non-automotive qualified products — Unless this data sheet expressly states that this specific NXP Semiconductors product is automotive qualified, the product is not suitable for automotive use. It is neither qualified nor tested in accordance with automotive testing or application requirements. NXP Semiconductors accepts no liability for inclusion and/or use of non-automotive qualified products in automotive equipment or applications.

In the event that customer uses the product for design-in and use in automotive applications to automotive specifications and standards, customer (a) shall use the product without NXP Semiconductors' warranty of the product for such automotive applications, use and specifications, and (b) whenever customer uses the product for automotive applications beyond

NXP Semiconductors' specifications such use shall be solely at customer's own risk, and (c) customer fully indemnifies NXP Semiconductors for any liability, damages or failed product claims resulting from customer design and use of the product for automotive applications beyond NXP Semiconductors' standard warranty and NXP Semiconductors' product specifications.

Translations — A non-English (translated) version of a document is for reference only. The English version shall prevail in case of any discrepancy between the translated and English versions.

18.4 Trademarks

Notice: All referenced brands, product names, service names and trademarks are the property of their respective owners.

19. Contact information

For more information, please visit: <http://www.nxp.com>

For sales office addresses, please send an email to: salesaddresses@nxp.com

20. Contents

1	General description	1	20	Contents	24
2	Features and benefits	1			
3	Applications	2			
4	Ordering information	2			
5	Marking	2			
6	Functional diagram	2			
7	Pinning information	3			
7.1	Pinning	3			
7.2	Pin description	3			
8	Functional description	3			
8.1	EN input	4			
8.2	UnderVoltage LockOut (UVLO)	4			
8.3	ILIM	4			
8.4	OverCurrent Protection (OCP)	4			
8.4.1	Overcurrent at start-up	4			
8.4.2	Overcurrent when enabled	4			
8.4.3	Short-circuit when enabled	4			
8.5	Reverse-Voltage Protection (RVP)	4			
8.6	FAULT output	5			
8.7	OverTemperature Protection (OTP)	5			
9	Limiting values	5			
10	Recommended operating conditions	6			
11	Thermal characteristics	6			
12	Static characteristics	6			
12.1	Graphs	7			
12.2	ON resistance	8			
12.3	ON resistance graph	9			
12.4	Current limit	9			
12.5	Current limit graph	10			
12.6	Thermal shutdown	10			
13	Dynamic characteristics	10			
13.1	Waveform and test circuits	11			
14	Application information	16			
14.1	Application diagram	16			
14.2	Best practices	16			
15	Package outline	18			
16	Abbreviations	21			
17	Revision history	21			
18	Legal information	22			
18.1	Data sheet status	22			
18.2	Definitions	22			
18.3	Disclaimers	22			
18.4	Trademarks	23			
19	Contact information	23			

Please be aware that important notices concerning this document and the product(s) described herein, have been included in section 'Legal information'.

© NXP Semiconductors N.V. 2015.

All rights reserved.

For more information, please visit: <http://www.nxp.com>



For sales office addresses, please send an email to: salesaddresses@nxp.com

Date of release: 6 July 2015

Document identifier: NX5P2553

Looking for pricing, stock, or lifecycle information?

Click below to explore more details on WIN SOURCE:

-  [View NX5P2553GU6Z on WIN SOURCE](#)
-  [NXP / Nexperia Information](#)

Optimize Your Supply Chain with WIN SOURCE Solutions

-  Global Sourcing Solution
-  Obsolete Management
-  Cost Control Management
-  Shortage Management
-  Alternative Solution
-  Excess Inventory Management