



THE DATASHEET OF MUR2060FCT



MUR2060CT/MUR2060FCT

Ultrafast Recovery Rectifiers
 Reverse Voltage 600V Forward Current 20 A

Features

- FRED (Planar) wafer construction
- Ultrafast recovery time
- Low forward voltage drop, low power loss
- High efficiency
- Plastic package has underwriters Laboratory Flammability Classification 94V-0



MUR2060CT
 Package: TO-220-AB

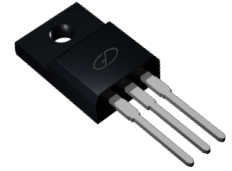

MUR2060FCT
 Package: ITO-220-AB

Mechanical Data

- Case: Epoxy, molded
- Weight: 1.9 grams (approximately)
- Finish: all external surfaces corrosion resistant and terminal leads readily solderable
- Lead temperature for soldering purposes: 260°C Max. for 10 sec
- 50 units per plastic tube

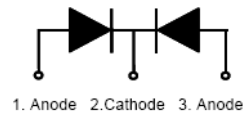

1. Anode 2. Cathode 3. Anode

Schematic Diagram

Maximum Ratings & Electrical Characteristics

($T_A=25^{\circ}\text{C}$ unless otherwise noted)

Parameter	Test Conditions		Symbol	Value	Unit
Maximum Repetitive Peak Reverse Voltage			V_{RRM}	600	V
Working Peak Reverse Voltage			V_{RWM}	600	V
Maximum DC Blocking Voltage			V_{DC}	600	V
Maximum Average Forward Rectified Current @ $T_c=105^{\circ}\text{C}$	Total Device		$I_{F(AV)}$	20	A
	Per Diode			10	
Peak Forward Surge Current 8.3ms Single Half Sine-wave Superimposed on Rated Load per Diode			I_{FSM}	125	A
Voltage Rate of Change (rated V_R)			DV/dt	10000	V/ μs
Operating Junction Temperature Range			T_J	- 55 to+150	$^{\circ}\text{C}$
Storage Temperature Range			T_{STG}	- 55 to+150	$^{\circ}\text{C}$
Maximum Reverse Recover Time ($I_F=0.5\text{A}$, $I_R=1.0\text{A}$, $I_{rec}=0.25\text{A}$)			T_{rr}	50	ns
Maximum Instantaneous Forward Voltage per Leg	$I_F=10\text{A}$	$T_C=25^{\circ}\text{C}$	V_F	1.60	V
	$I_F=10\text{A}$	$T_C=125^{\circ}\text{C}$		1.50	
Maximum Reverse Current per Leg at Working Peak Reverse Voltage		$T_J=25^{\circ}\text{C}$	I_R	10	μA
		$T_J=100^{\circ}\text{C}$		500	μA
Thermal Characteristics $T_A=25^{\circ}\text{C}$ unless otherwise noted					
Symbol	Parameter		Typ.(MUR2060CT)	Typ.(MUR2060FCT)	Unit
$R_{\theta JC}$	Thermal Resistance, Junction to Case per Leg		2.0	4.0	$^{\circ}\text{C}/\text{W}$
$R_{\theta JA}$	Thermal Resistance, Junction to Ambient per Leg		62.5	62.5	$^{\circ}\text{C}/\text{W}$

Note: Pulse test:300us pulse width, duty cycle=2%

MUR2060CT/MUR2060FCT

Ultrafast Recovery Rectifiers
 Reverse Voltage 600V Forward Current 20 A

Ratings and Characteristics Curves ($T_A = 25^\circ\text{C}$ unless otherwise noted)

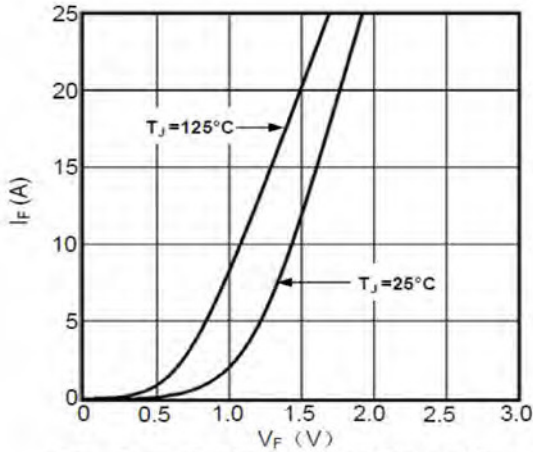

Fig1. Forward Voltage Drop vs Forward Current

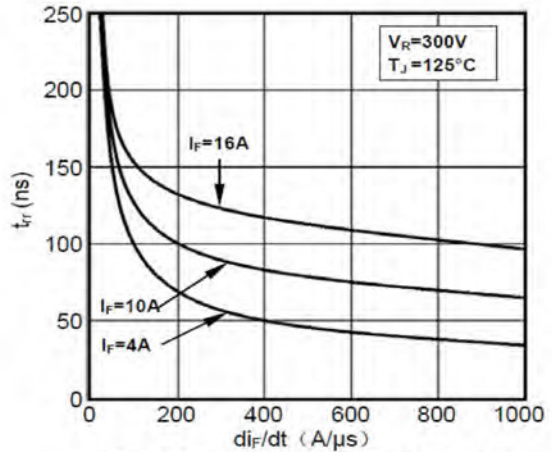

Fig2. Reverse Recovery Time vs di_F/dt

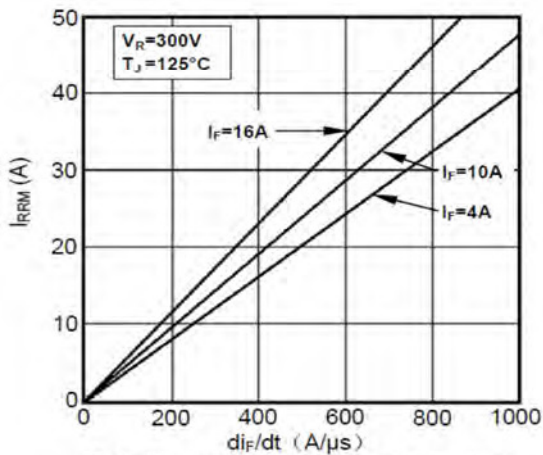

Fig3. Reverse Recovery Current vs di_F/dt

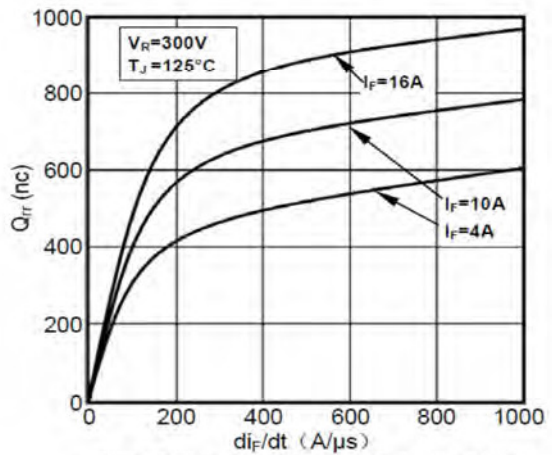

Fig4. Reverse Recovery Charge vs di_F/dt

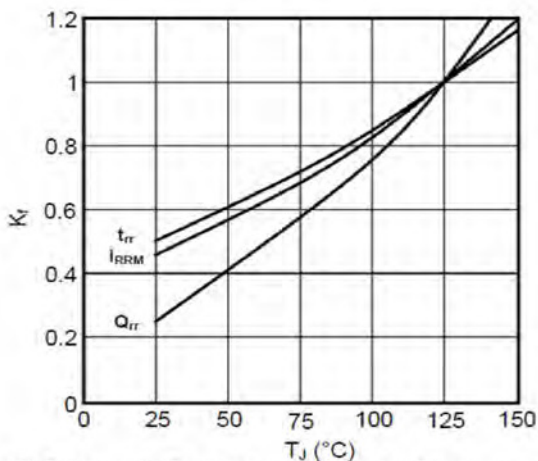

Fig5. Dynamic Parameters vs Junction Temperature

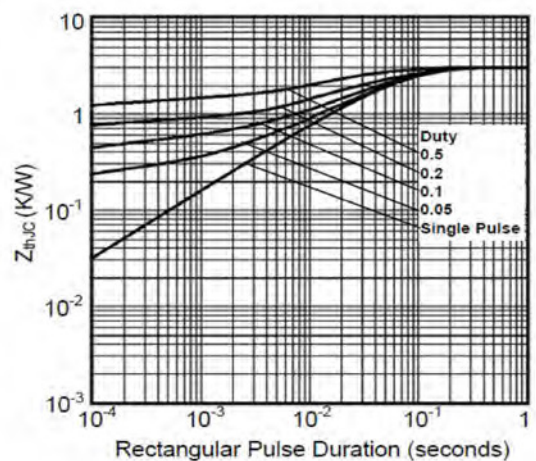

Fig6. Transient Thermal Impedance

MUR2060CT/MUR2060FCT

Ultrafast Recovery Rectifiers
 Reverse Voltage 600V Forward Current 20 A

Package Outline Dimensions

in millimeters

TO-220-AB

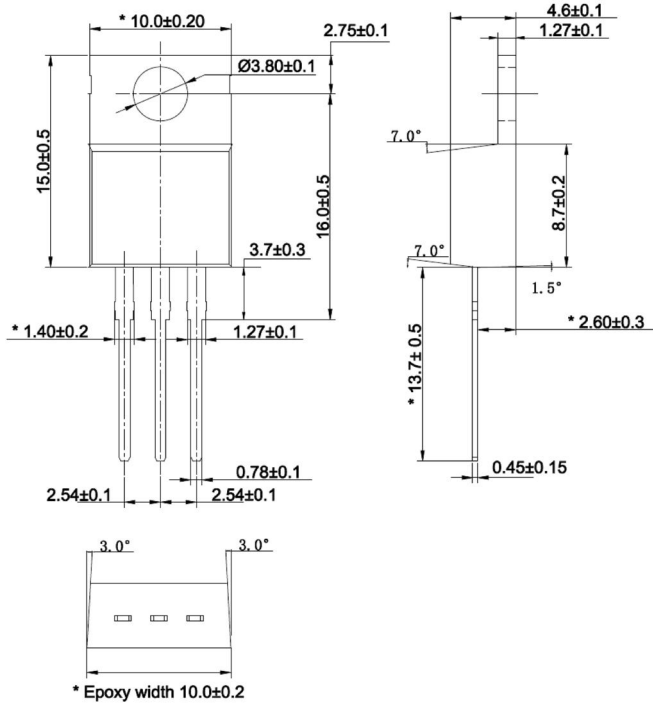

ITO-220-AB

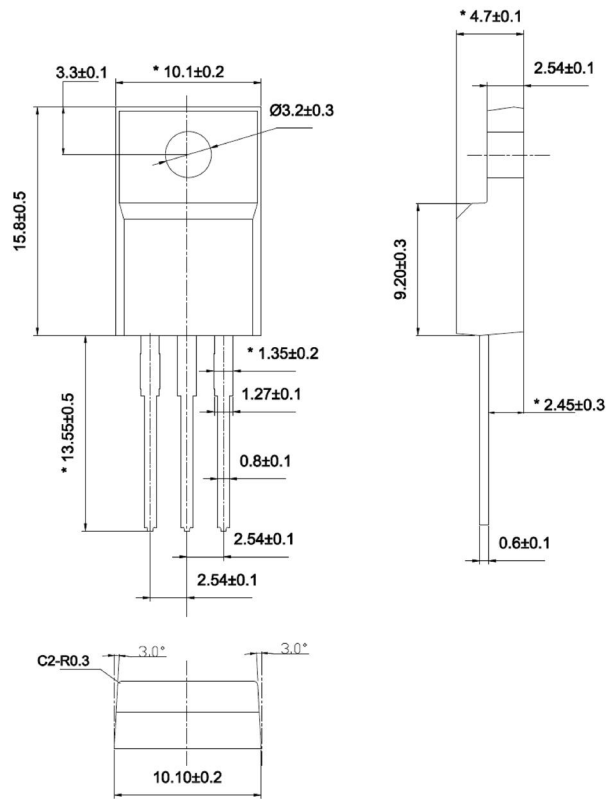

Looking for pricing, stock, or lifecycle information?

Click below to explore more details on WIN SOURCE:

- ⊖ [View MUR2060FCT on WIN SOURCE](#)
- ⊖ [GOOD-ARK Electronics Information](#)

Optimize Your Supply Chain with WIN SOURCE Solutions

- ✓ Global Sourcing Solution
- ✓ Obsolete Management
- ✓ Cost Control Management
- ✓ Shortage Management
- ✓ Alternative Solution
- ✓ Excess Inventory Management