

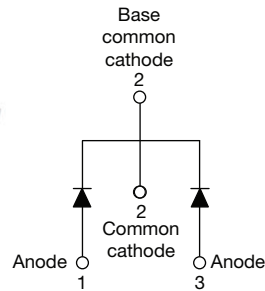

**THE DATASHEET OF  
VS-MUR2020CT-M3**



## Ultrafast Rectifier, 2 x 10 A FRED Pt<sup>®</sup>

**TO-220AB 3L**

### FEATURES

- Ultrafast recovery time
- Low forward voltage drop
- 175 °C operating junction temperature
- Low leakage current
- Designed and qualified according to JEDEC<sup>®</sup>-JESD 47
- Material categorization: for definitions of compliance please see [www.vishay.com/doc?99912](http://www.vishay.com/doc?99912)

**RoHS**  
 COMPLIANT  
 HALOGEN  
**FREE**

### DESCRIPTION / APPLICATIONS

VS-MUR2020CT-M3 is the state of the art ultrafast recovery rectifier specifically designed with optimized performance of forward voltage drop and ultrafast recovery time.

The planar structure and the platinum doped life time control, guarantee the best overall performance, ruggedness and reliability characteristics.

These devices are intended for use in the output rectification stage of SMPS, UPS, DC/DC converters as well as freewheeling diode in low voltage inverters and chopper motor drives.

Their extremely optimized stored charge and low recovery current minimize the switching losses and reduce over dissipation in the switching element and snubbers.

### MECHANICAL DATA

**Case:** TO-220AB

Molding compound meets UL 94 V-0 flammability rating

**Terminals:** matte tin plated leads, solderable per J-STD-002

### LINKS TO ADDITIONAL RESOURCES



PRIMARY CHARACTERISTICS	
$I_{F(AV)}$	2 x 10 A
$V_R$	200 V
$V_F$ at $I_F$	0.85 V
$t_{rr}$ typ.	19 ns
$T_J$ max.	175 °C
Package	TO-220AB 3L
Circuit configuration	Common cathode

ABSOLUTE MAXIMUM RATINGS				
PARAMETER	SYMBOL	TEST CONDITIONS	MAX.	UNITS
Peak repetitive reverse voltage	$V_{RRM}$		200	V
Average rectified forward current	$I_{F(AV)}$	per leg	10	A
		total device	20	
Non-repetitive peak surge current per leg	$I_{FSM}$	Rated $V_R$ , $T_C = 145$ °C	100	
Peak repetitive forward current per leg	$I_{FM}$	Rated $V_R$ , square wave, 20 kHz, $T_C = 145$ °C	20	
Operating junction and storage temperatures	$T_J, T_{Stg}$		-65 to +175	°C

ELECTRICAL SPECIFICATIONS ( $T_J = 25$ °C unless otherwise specified)						
PARAMETER	SYMBOL	TEST CONDITIONS	MIN.	TYP.	MAX.	UNITS
Breakdown voltage, blocking voltage	$V_{BR}, V_R$	$I_R = 100$ $\mu$ A	200	-	-	V
Forward voltage	$V_F$	$I_F = 8$ A, $T_J = 125$ °C	-	-	0.85	
		$I_F = 16$ A	-	-	1.15	
		$I_F = 16$ A, $T_J = 125$ °C	-	-	1.05	
Reverse leakage current	$I_R$	$V_R = V_R$ rated	-	-	15	$\mu$ A
		$T_J = 150$ °C, $V_R = V_R$ rated	-	-	250	
Junction capacitance	$C_T$	$V_R = 200$ V	-	55	-	pF
Series inductance	$L_S$	Measured lead to lead 5 mm from package body	-	8.0	-	nH



DYNAMIC RECOVERY CHARACTERISTICS (T <sub>J</sub> = 25 °C unless otherwise specified)						
PARAMETER	SYMBOL	TEST CONDITIONS	MIN.	TYP.	MAX.	UNITS
Reverse recovery time	t <sub>rr</sub>	I <sub>F</sub> = 1.0 A, dI <sub>F</sub> /dt = 50 A/μs, V <sub>R</sub> = 30 V	-	-	35	ns
		I <sub>F</sub> = 0.5 A, I <sub>R</sub> = 1.0 A, I <sub>REC</sub> = 0.25 A	-	-	25	
		T <sub>J</sub> = 25 °C	-	21	-	
		T <sub>J</sub> = 125 °C	-	35	-	
Peak recovery current	I <sub>RRM</sub>	T <sub>J</sub> = 25 °C	-	1.9	-	A
		T <sub>J</sub> = 125 °C	-	4.8	-	
Reverse recovery charge	Q <sub>rr</sub>	T <sub>J</sub> = 25 °C	-	25	-	nC
		T <sub>J</sub> = 125 °C	-	78	-	

THERMAL MECHANICAL SPECIFICATIONS						
PARAMETER	SYMBOL	TEST CONDITIONS	MIN.	TYP.	MAX.	UNITS
Maximum junction and storage temperature range	T <sub>J</sub> , T <sub>Stg</sub>		-65	-	175	°C
Thermal resistance, junction to case	R <sub>thJC</sub>	per leg	-	-	2.5	°C/W
		total device	-	-	1.25	
Thermal resistance, junction to ambient per leg	R <sub>thJA</sub>		-	-	50	
Thermal resistance, case to heatsink	R <sub>thCS</sub>	Mounting surface, flat, smooth and greased	-	0.5	-	
Weight			-	2.0	-	g
Mounting torque			6.0 (5.0)	-	12 (10)	kgf · cm (lbf · in)
Marking device		Case style TO-220AB 3L	MUR2020CT			

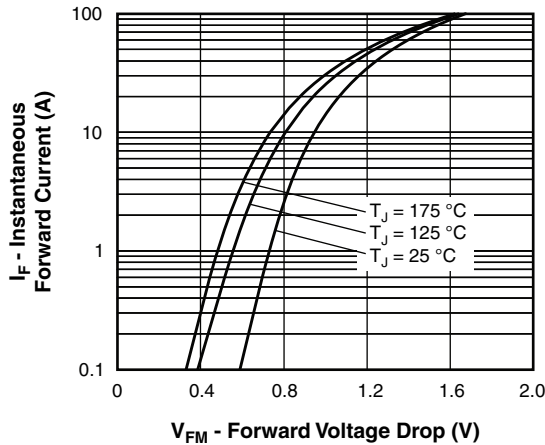

Fig. 1 - Maximum Forward Voltage Drop Characteristics

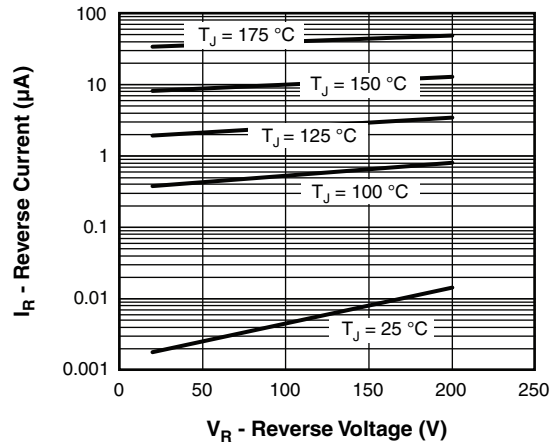

Fig. 2 - Typical Values of Reverse Current vs. Reverse Voltage

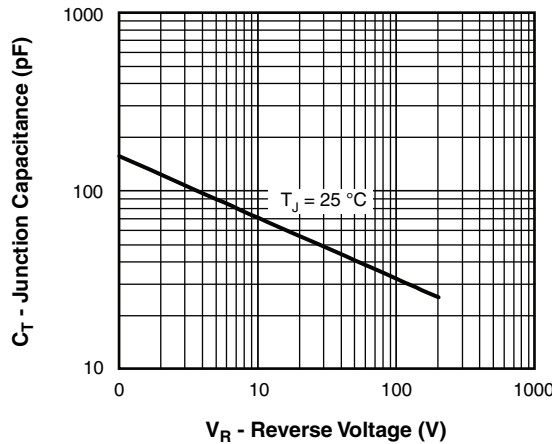

Fig. 3 - Typical Junction Capacitance vs. Reverse Voltage

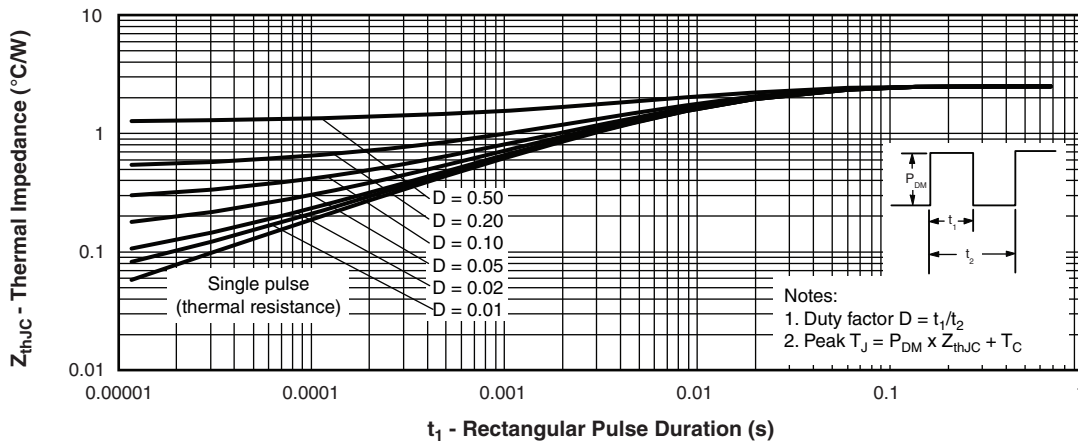

Fig. 4 - Maximum Thermal Impedance  $Z_{thJC}$  Characteristics

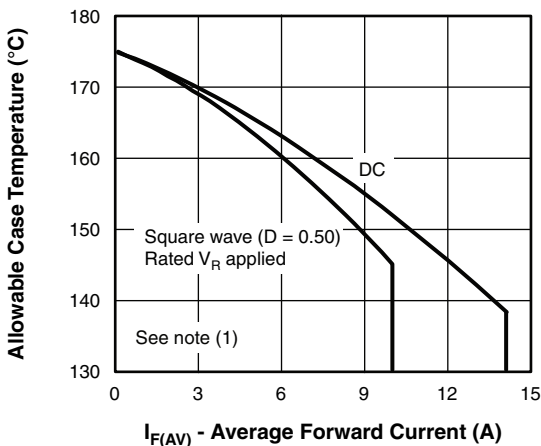

Fig. 5 - Maximum Allowable Case Temperature vs. Average Forward Current

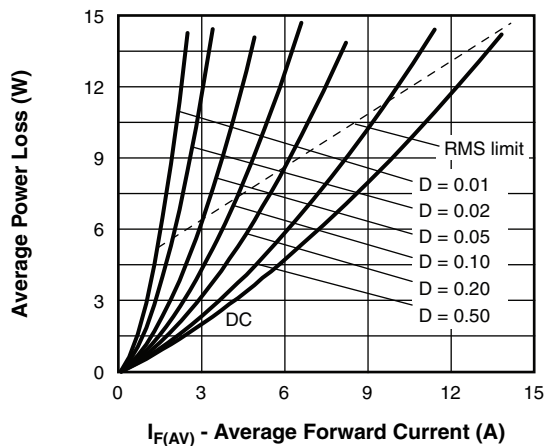

Fig. 6 - Forward Power Loss Characteristics

**Note**

- (1) Formula used:  $T_C = T_J - (P_d + P_{d_{REV}}) \times R_{thJC}$ ;  
 $P_d$  = forward power loss =  $I_{F(AV)} \times V_{FM}$  at  $(I_{F(AV)}/D)$  (see fig. 6);  
 $P_{d_{REV}}$  = inverse power loss =  $V_{R1} \times I_R (1 - D)$ ;  $I_R$  at  $V_{R1}$  = rated  $V_R$

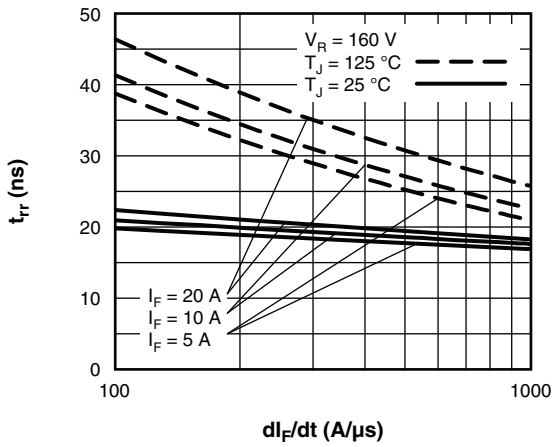

Fig. 7 - Typical Reverse Recovery Time vs.  $di_F/dt$

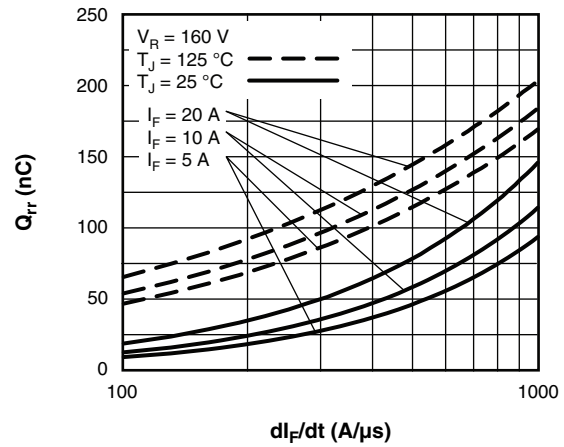
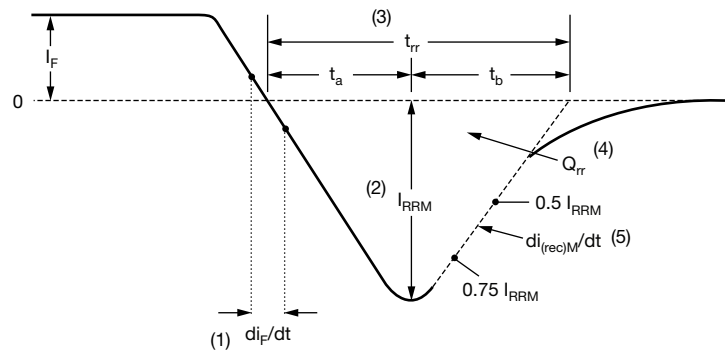

Fig. 8 - Typical Stored Charge vs.  $di_F/dt$



- (1)  $di_F/dt$  - rate of change of current through zero crossing
- (2)  $I_{RRM}$  - peak reverse recovery current
- (3)  $t_{rr}$  - reverse recovery time measured from zero crossing point of negative going  $I_F$  to point where a line passing through  $0.75 I_{RRM}$  and  $0.50 I_{RRM}$  extrapolated to zero current.
- (4)  $Q_{rr}$  - area under curve defined by  $t_{rr}$  and  $I_{RRM}$
- (5)  $di_{(rec)M}/dt$  - peak rate of change of current during  $t_b$  portion of  $t_{rr}$

$$Q_{rr} = \frac{t_{rr} \times I_{RRM}}{2}$$

Fig. 9 - Reverse Recovery Waveform and Definitions



## ORDERING INFORMATION TABLE

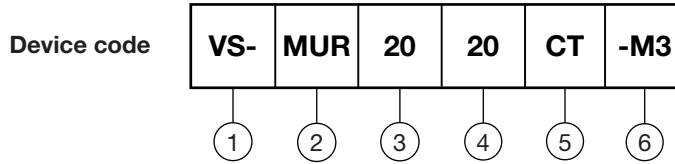

- 1** - Vishay Semiconductors product
- 2** - Ultrafast MUR series
- 3** - Current rating (20 = 20 A)
- 4** - Voltage rating (20 = 200 V)
- 5** - CT = center tap (dual)
- 6** - Environmental digit:  
-M3 = halogen-free, RoHS-compliant, and termination lead (Pb)-free

<b>ORDERING INFORMATION</b> (Example)		
PREFERRED P/N	BASE QUANTITY	PACKAGING DESCRIPTION
VS-MUR2020CT-M3	50	Antistatic plastic tubes

<b>LINKS TO RELATED DOCUMENTS</b>	
Dimensions	<a href="http://www.vishay.com/doc?96154">www.vishay.com/doc?96154</a>
Part marking information	<a href="http://www.vishay.com/doc?95028">www.vishay.com/doc?95028</a>
SPIICE model	<a href="http://www.vishay.com/doc?96995">www.vishay.com/doc?96995</a>



TO-220AB 3L

DIMENSIONS in millimeters and inches

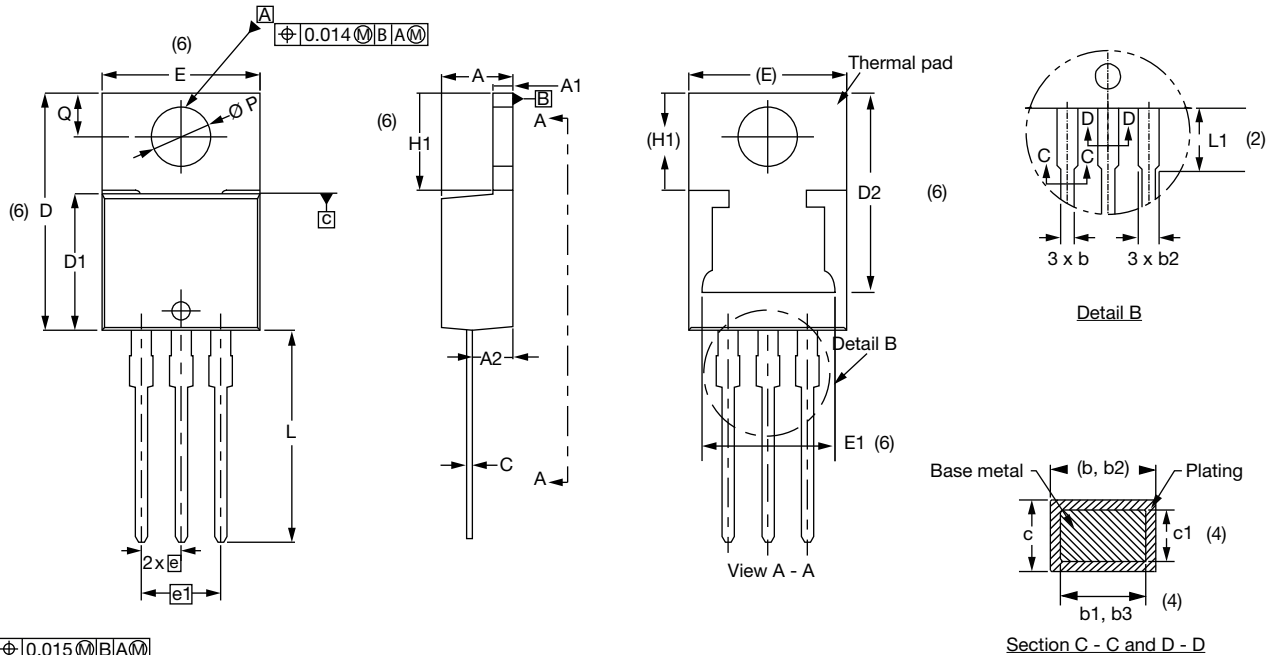

Conforms to JEDEC® outline TO-220AB

SYMBOL	MILLIMETERS		INCHES		NOTES	SYMBOL	MILLIMETERS		INCHES		NOTES
	MIN.	MAX.	MIN.	MAX.			MIN.	MAX.	MIN.	MAX.	
A	4.25	4.65	0.167	0.183		D2	11.68	13.30	0.460	0.524	6, 7
A1	1.14	1.40	0.045	0.055		E	10.11	10.51	0.398	0.414	3, 6
A2	2.50	2.92	0.098	0.115		E1	6.86	8.89	0.270	0.350	6
b	0.69	1.01	0.027	0.040		e	2.41	2.67	0.095	0.105	
b1	0.38	0.97	0.015	0.038	4	e1	4.88	5.28	0.192	0.208	
b2	1.20	1.73	0.047	0.068		H1	6.09	6.48	0.240	0.255	6
b3	1.14	1.73	0.045	0.068	4	L	13.52	14.02	0.532	0.552	
c	0.36	0.61	0.014	0.024		L1	3.32	3.82	0.131	0.150	2
c1	0.36	0.56	0.014	0.022	4	∅ P	3.54	3.91	0.139	0.154	
D	14.85	15.35	0.585	0.604	3	Q	2.60	3.00	0.102	0.118	
D1	8.38	9.02	0.330	0.355							

Notes

- (1) Dimensioning and tolerancing as per ASME Y14.5M-1994
- (2) Lead dimension and finish uncontrolled in L1
- (3) Dimension D, D1, and E do not include mold flash. Mold flash shall not exceed 0.127 mm (0.005") per side. These dimensions are measured at the outermost extremes of the plastic body
- (4) Dimension b1, b3, and c1 apply to base metal only
- (5) Controlling dimensions: inches
- (6) Thermal pad contour optional within dimensions E, H1, D2, and E1
- (7) Outline conforms to JEDEC® TO-220, except D2



## Disclaimer

ALL PRODUCT, PRODUCT SPECIFICATIONS AND DATA ARE SUBJECT TO CHANGE WITHOUT NOTICE TO IMPROVE RELIABILITY, FUNCTION OR DESIGN OR OTHERWISE.

Vishay Intertechnology, Inc., its affiliates, agents, and employees, and all persons acting on its or their behalf (collectively, "Vishay"), disclaim any and all liability for any errors, inaccuracies or incompleteness contained in any datasheet or in any other disclosure relating to any product.

Vishay makes no warranty, representation or guarantee regarding the suitability of the products for any particular purpose or the continuing production of any product. To the maximum extent permitted by applicable law, Vishay disclaims (i) any and all liability arising out of the application or use of any product, (ii) any and all liability, including without limitation special, consequential or incidental damages, and (iii) any and all implied warranties, including warranties of fitness for particular purpose, non-infringement and merchantability.

Statements regarding the suitability of products for certain types of applications are based on Vishay's knowledge of typical requirements that are often placed on Vishay products in generic applications. Such statements are not binding statements about the suitability of products for a particular application. It is the customer's responsibility to validate that a particular product with the properties described in the product specification is suitable for use in a particular application. Parameters provided in datasheets and / or specifications may vary in different applications and performance may vary over time. All operating parameters, including typical parameters, must be validated for each customer application by the customer's technical experts. Product specifications do not expand or otherwise modify Vishay's terms and conditions of purchase, including but not limited to the warranty expressed therein.

Hyperlinks included in this datasheet may direct users to third-party websites. These links are provided as a convenience and for informational purposes only. Inclusion of these hyperlinks does not constitute an endorsement or an approval by Vishay of any of the products, services or opinions of the corporation, organization or individual associated with the third-party website. Vishay disclaims any and all liability and bears no responsibility for the accuracy, legality or content of the third-party website or for that of subsequent links.

Vishay products are not designed for use in life-saving or life-sustaining applications or any application in which the failure of the Vishay product could result in personal injury or death unless specifically qualified in writing by Vishay. Customers using or selling Vishay products not expressly indicated for use in such applications do so at their own risk. Please contact authorized Vishay personnel to obtain written terms and conditions regarding products designed for such applications.

No license, express or implied, by estoppel or otherwise, to any intellectual property rights is granted by this document or by any conduct of Vishay. Product names and markings noted herein may be trademarks of their respective owners.

## Looking for pricing, stock, or lifecycle information?

Click below to explore more details on WIN SOURCE:

 [View VS-MUR2020CT-M3 on WIN SOURCE](#)

 [Vishay Information](#)

## Optimize Your Supply Chain with WIN SOURCE Solutions

-  Global Sourcing Solution
-  Obsolete Management
-  Cost Control Management
-  Shortage Management
-  Alternative Solution
-  Excess Inventory Management