



**THE DATASHEET OF
MPI-650-20**



Chassis Mount

MPI Series

Multi-Purpose International Transformers

High Performance with Greater Volumetric Efficiency

Signal's MPI transformers feature higher volumetric efficiency for improved performance compared with conventional 50/60 Hz transformers. They also incorporate international safety features making them ideal for worldwide applications.

General Specifications

- Power - 200 VA to 900 VA
- Dielectric Strength - 4000 Vrms Hipot
- Primaries - Dual / tapped primaries 100 V, 115 V, 200 V, 215 V, 230 V - 50/60 Hz
- Dual Secondaries - Series or parallel
- Electrostatic Shield - Solid copper full width foil
- Touch Safe IP20 Type Terminals - Quick connect 3/16" and 1/4" Fast-On, plus screw/binding clamps
- Leakage - <100 micro amps
- Insulation System - Class F, 155° C

Agency Certifications

- UL 1446, File # E66312, UL recognized to UL 506 / UL 5085-2, File # E63829
- CSA certified to C22.2 No. 66.1, File # 221070
- Designed to meet VDE 0868 and VDE 0570
- TUV Rheinland certified to IEC EN61558-2-4 and EN61558-2-6, License # R72042497

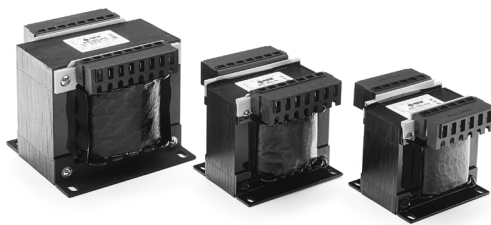

Part Number Selection

Part Number	Secondary	
	Series	Parallel
MPI-200-10	10 VCT @ 20.0 A	5 V @ 40.0 A
MPI-250-10	10 VCT @ 25.0 A	5 V @ 50.0 A
MPI-300-10	10 VCT @ 30.0 A	5 V @ 60.0 A
MPI-400-10	10 VCT @ 40.0 A	5 V @ 80.0 A
MPI-650-10	10 VCT @ 65.0 A	5 V @ 130.0 A
MPI-900-10	10 VCT @ 90.0 A	5 V @ 180.0 A
MPI-200-12	12 VCT @ 16.7 A	6 V @ 33.3 A
MPI-250-12	12 VCT @ 20.8 A	6 V @ 41.7 A
MPI-300-12	12 VCT @ 25.0 A	6 V @ 50.0 A
MPI-400-12	12 VCT @ 33.3 A	6 V @ 66.6 A
MPI-650-12	12 VCT @ 54.2 A	6 V @ 108.4 A
MPI-900-12	12 VCT @ 75.0 A	6 V @ 150.0 A
MPI-200-16	16 VCT @ 12.5 A	8 V @ 25.0 A
MPI-250-16	16 VCT @ 15.6 A	8 V @ 31.2 A
MPI-300-16	16 VCT @ 18.8 A	8 V @ 37.6 A
MPI-400-16	16 VCT @ 25.0 A	8 V @ 50.0 A
MPI-650-16	16 VCT @ 40.6 A	8 V @ 81.2 A
MPI-900-16	16 VCT @ 56.3 A	8 V @ 112.5 A
MPI-200-20	20 VCT @ 10.0 A	10 V @ 20.0 A
MPI-250-20	20 VCT @ 12.5 A	10 V @ 25.0 A
MPI-300-20	20 VCT @ 15.0 A	10 V @ 30.0 A
MPI-400-20	20 VCT @ 20.0 A	10 V @ 40.0 A
MPI-650-20	20 VCT @ 32.5 A	10 V @ 65.0 A
MPI-900-20	20 VCT @ 45.0 A	10 V @ 90.0 A
MPI-200-24	24 VCT @ 8.3 A	12 V @ 16.7 A
MPI-250-24	24 VCT @ 10.4 A	12 V @ 20.8 A
MPI-300-24	24 VCT @ 12.5 A	12 V @ 25.0 A
MPI-400-24	24 VCT @ 16.7 A	12 V @ 33.3 A
MPI-650-24	24 VCT @ 27.1 A	12 V @ 54.2 A
MPI-900-24	24 VCT @ 37.5 A	12 V @ 75.0 A

Part Number	Secondary	
	Series	Parallel
MPI-200-28	28 VCT @ 7.1 A	14 V @ 14.2 A
MPI-250-28	28 VCT @ 8.9 A	14 V @ 17.9 A
MPI-300-28	28 VCT @ 10.7 A	14 V @ 21.4 A
MPI-400-28	28 VCT @ 14.3 A	14 V @ 28.6 A
MPI-650-28	28 VCT @ 23.2 A	14 V @ 46.4 A
MPI-900-28	28 VCT @ 32.1 A	14 V @ 64.2 A
MPI-200-36	36 VCT @ 5.6 A	18 V @ 11.2 A
MPI-250-36	36 VCT @ 6.9 A	18 V @ 13.8 A
MPI-300-36	36 VCT @ 8.3 A	18 V @ 16.7 A
MPI-400-36	36 VCT @ 11.1 A	18 V @ 22.2 A
MPI-650-36	36 VCT @ 18.1 A	18 V @ 36.2 A
MPI-900-36	36 VCT @ 25.0 A	18 V @ 50.0 A
MPI-200-40	40 VCT @ 5.0 A	20 V @ 10.0 A
MPI-250-40	40 VCT @ 6.3 A	20 V @ 12.6 A
MPI-300-40	40 VCT @ 7.5 A	20 V @ 15.0 A
MPI-400-40	40 VCT @ 10.0 A	20 V @ 20.0 A
MPI-650-40	40 VCT @ 16.3 A	20 V @ 32.6 A
MPI-900-40	40 VCT @ 22.5 A	20 V @ 45.0 A
MPI-200-48	48 VCT @ 4.2 A	24 V @ 8.3 A
MPI-250-48	48 VCT @ 5.2 A	24 V @ 10.4 A
MPI-300-48	48 VCT @ 6.3 A	24 V @ 12.6 A
MPI-400-48	48 VCT @ 8.3 A	24 V @ 16.7 A
MPI-650-48	48 VCT @ 13.5 A	24 V @ 27.1 A
MPI-900-48	48 VCT @ 18.8 A	24 V @ 37.5 A
MPI-200-230	230 VCT @ 0.87 A	115 V @ 1.7 A
MPI-250-230	230 VCT @ 1.1 A	115 V @ 2.2 A
MPI-300-230	230 VCT @ 1.3 A	115 V @ 2.6 A
MPI-400-230	230 VCT @ 1.7 A	115 V @ 3.4 A
MPI-650-230	230 VCT @ 2.8 A	115 V @ 5.6 A
MPI-900-230	230 VCT @ 3.9 A	115 V @ 7.8 A



Custom versions available upon request.



128 Atlantic Avenue, Lynbrook, NY 11563
 Toll Free 866-239-5777 | Tel 516-239-5777 | Fax 516-239-7208
 sales@signaltransformer.com | techhelp@signaltransformer.com

belfuse.com/signal

Mechanical Specifications

VA	Mechanical Dimensions					Weight	Slot Size
	L	W	H	ML	MW		
Size	Inches (mm)					lbs (kg)	Inches (mm)
200	3.75 (95.3)	4.30 (109.2)	3.66 (93.1)	3.25 (82.6)	2.80 (71.1)	6.22 (2.82)	.203 x .375 (5.2 x 9.5)
250	4.12 (104.8)	4.13 (104.9)	3.86 (98.2)	3.62 (92.1)	2.60 (66.1)	6.76 (3.07)	.203 x .375 (5.2 x 9.5)
300	4.12 (104.8)	4.30 (109.2)	3.86 (98.2)	3.62 (92.1)	2.91 (74.0)	7.80 (3.54)	.203 x .375 (5.2 x 9.5)
400	4.12 (104.8)	5.04 (128.1)	3.86 (98.2)	3.62 (92.1)	3.50 (89.0)	9.82 (4.46)	.203 x .375 (5.2 x 9.5)
650	5.25 (133.3)	4.70 (119.4)	4.63 (117.8)	4.50 (114.3)	3.41 (86.7)	14.83 (6.73)	.281 x .563 (7.1 x 14.3)
900	5.25 (133.3)	5.50 (139.7)	4.63 (117.8)	4.50 (114.3)	4.20 (106.8)	19.84 (9.01)	.281 x .563 (7.1 x 14.3)

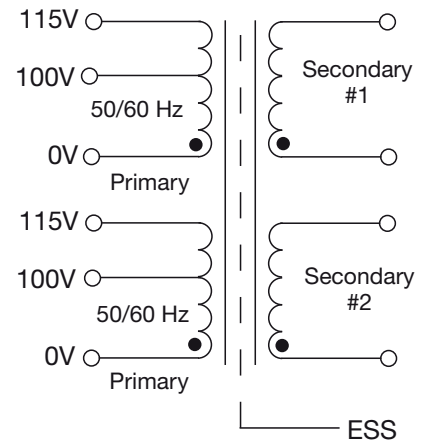
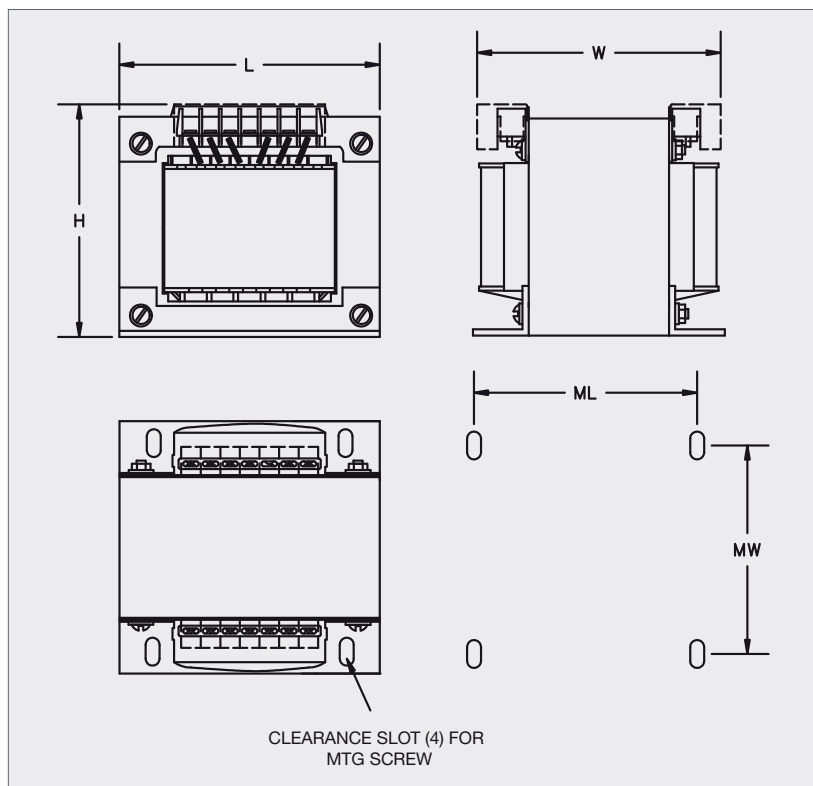

Custom versions available upon request.



128 Atlantic Avenue, Lynbrook, NY 11563
 Toll Free 866-239-5777 | Tel 516-239-5777 | Fax 516-239-7208
 sales@signaltransformer.com | techhelp@signaltransformer.com

belfuse.com/signal

Looking for pricing, stock, or lifecycle information?

Click below to explore more details on WIN SOURCE:

- ⊖ [View MPI-650-20 on WIN SOURCE](#)
- ⊖ [Signal Transformer Information](#)

Optimize Your Supply Chain with WIN SOURCE Solutions

- ✓ Global Sourcing Solution
- ✓ Obsolete Management
- ✓ Cost Control Management
- ✓ Shortage Management
- ✓ Alternative Solution
- ✓ Excess Inventory Management