



**THE DATASHEET OF
EV4700-S-00A**



DESCRIPTION

The EV4700-S-00A is the Evaluation Board designed to demonstrate the capabilities of MP4700 for TV backlighting applications. The MP4700 is a high efficiency step-down converter controller designed for driving the high brightness LEDs.

With a 250-300V input V_{IN} and an 8-18V power supply for MP4700, the EV4700-S-00A can drive a LED string up to 200V, and the LED current is regulated to 250mA. The EVB realizes input UVLO by INUV pin, the PWM dimming can be implemented by applying a PWM dimming signal on PWM pin. The short LED load protection and Over-Voltage protection are included.

ELECTRICAL SPECIFICATION

Parameter	Symbol	Value	Units
Input Voltage	V_{IN}	250-300	V
IC Power Supply	V_{supply}	8-18	V
LED Voltage	V_{LED}	200	V
LED Current	I_{LED}	250	mA
Over Voltage Protection	$V_{LED-Max}$	250	V

FEATURES

- 8V-to-18V IC Supply Voltage
- Constant-Current LED Driver
- Power MOSFET Zero-Current Turn-On
- No Freewheeling Diode Reverse Recovery Issues
- High Efficiency and Reliability in Boundary Conduction Mode
- Low 1mA Operation Current
- PWM Dimming Control
- Hiccup Short Circuit Protection
- UVLO for Bus Input Voltage
- Input UVLO, Thermal Shutdown
- Maximum Frequency Limited to 160kHz
- Available in SOIC8 Package

APPLICATIONS

- LED Backlighting for TV and Monitor
- DC/DC or AC/DC LED Driver applications
- General Illumination

All MPS parts are lead-free and adhere to the RoHS directive. For MPS green status, please visit MPS website under Quality Assurance. "MPS" and "The Future of Analog IC Technology", are Registered Trademarks of Monolithic Power Systems, Inc.



Warning: Although this board is designed to satisfy safety requirements, the engineering prototype has not been agency approved. Therefore, all testing should be performed using an isolation transformer to provide the AC input to the prototype board.

EV4700-S-00A EVALUATION BOARD

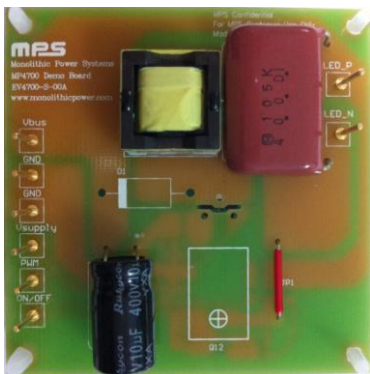

(L x W x H) 6.35cm x 6.35cm x 14mm

Board Number	MPS IC Number
EV4700-S-00A	MP4700

Efficiency vs. V_{IN}

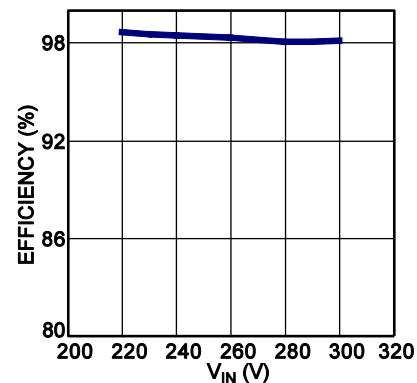

EV4700-S-00A BILL OF MATERIALS

Qty	Ref	Value	Description	Package	Manufacture	Manufacture_PN
1	C1	1 μ F	Capacitor;400V;CBB	DIP	Panasonic	ECQE4105KF
	C2	NS				
3	C3, C5, C8	1nF	Ceramic Capacitor;50V;X7R;0603;	0603	TDK	C1608X7R1H102K
1	C4	10pF	Capacitor;630V;X7R	0805	HQ	C0805C100KBRACU
1	C6	2.2 μ F/16V/0805	Ceramic Capacitor;16V;X7R;0805	0805	TDK	C2012X7R1C225K
1	C7	2.2 μ F/25V1206	Ceramic Capacitor;25V;X7R;1206	1206	muRata	GRM31MR71E225KA93L
1	C9	10 μ F	Electrolytic Capacitor;400V;Electrolytic	DIP	江海	CD11H-400V10
	D1	NS				
1	D2	1N4148W	Diode;75V;0.15A;	SOD-123	Diodes	1N4148W
1	D3	US1G	Diode;400V;1A;	SMA	MULTICOMP/Mic	US1G
1	D4	BZT52C6V8	Zener Diode;6.8V;5mA/500mW;	SOD-123	Diodes	BZT52C6V8-7
1	L1	1mH/0.6A	Inductor;1mH;EFD15, 140turns	DIP	E-MEI	FX330
1	Q1	STD3NK60ZT4	N-MOS/TO-252/DPAK	DPAK	ST	STD3NK60ZT4
1	Q2	FMMT558TA	Transistor;-400V;-150mA;500mW;	SOT-23	Zetex	FMMT558TA
1	Q3	2N7002-F	N-Channel Mosfet;60V;7500;115m	SOT-23	Diodes	2N7002-F
2	R1, R3	1M/1%	Film Resistor;1%	1206	Yageo	RC1206FR-071ML
	R2, R4, R9	NS				
1	R5	300k	Resistor;1%;1/4W	1206	Yageo	RC1206FR-07300KL
1	R6	10k/1%	Film Resistor;1%;1/10W	0603	Yageo	RC0603FR-0710KL
2	R7, R8	2k	Film Resistor;5%;1/10W	0603	LIZ	CR0603JA0202G
1	R10	20k	Film Resistor;1%;1/10W;	0603	Yageo	RC0603FR-0720KL
1	R11	0	Film Resistor;5%;	0603	Yageo	RC0603JR-070RL
2	R12, R13	1.1/1%	Film Resistor;1%	1206	Yageo	RC1206FR-071R1L
1	R14	750k	Film Resistor;1%	0603	Yageo	RC0603FR-07750KL
1	R15	10.7k	Film Resistor;1%;	0603	Yageo	RC0603FR-0710K7L
1	R16	100k	Film Resistor;1%;	0603	Yageo	RC0603FR-07100KL
1	U1	MP4700GS	LED Driver	SO8	MPS	MP4700GS

MAGNETIC COMPONENTS

A. FX330, Inductor (L1)

Electrical Diagram:

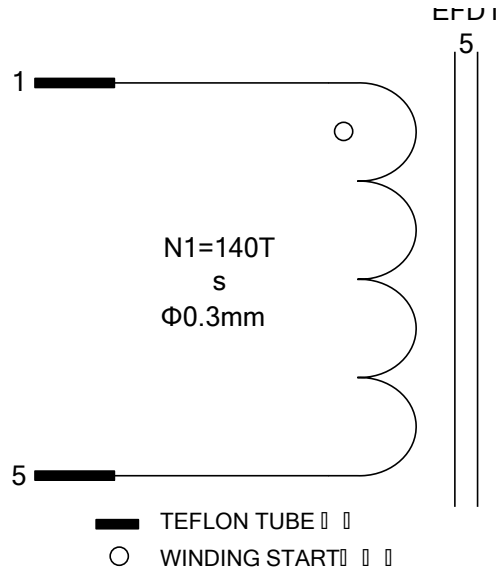

Winding Diagram

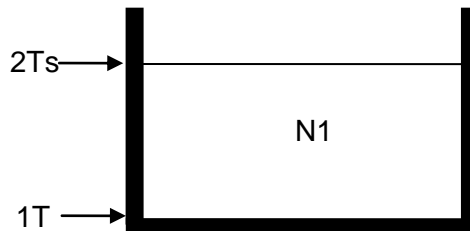

Winding Order

胶带圈数 (Tape Layer Number)	绕组顺序 (Winding No.)	始末脚位 (Start & End)	线径 ϕ (Magnet Wire)	圈数 (Turns)
1				
2	N1	4—8	0.3mm*1	140

Electric Characteristics

1	电感量 (Primary Inductance)	$L_p(4-8)$	1mH \pm 10%	100kHz
2	匝比 (Turn Ratio)	N1	140	
3	抗电强度 (Electrical Strength)	Pri. Side ~ Sec. Side	AC: 3000V	1s, 1mA
		Pri. Side ~ Core	AC: 2000V	
		Sec. Side ~ Core	AC: 2000V	

EVB TEST RESULTS

Performance waveforms are tested on the evaluation board.

$V_{IN} = 280V$, $V_{SUPPLY} = 13V$, $V_{LED} = 200V$, $I_{LED} = 250mA$, $T_A = 20^\circ C$, unless otherwise noted.

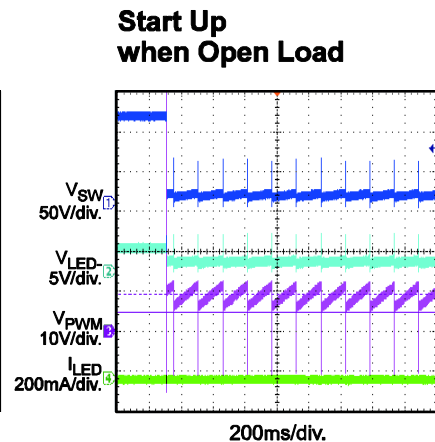
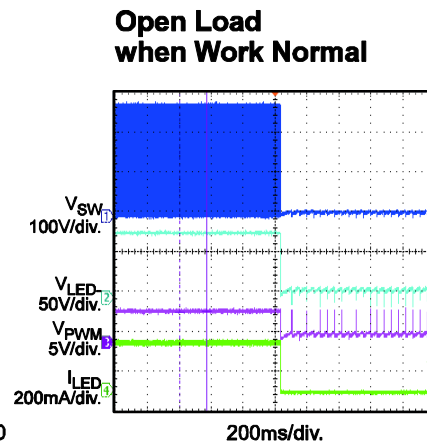
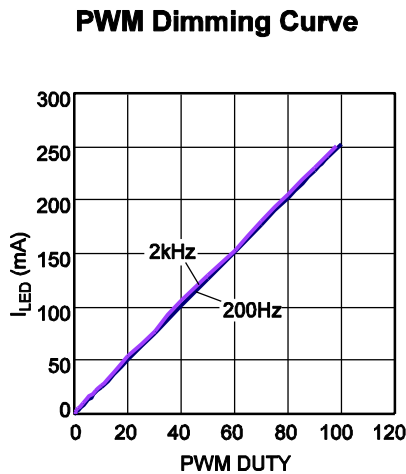
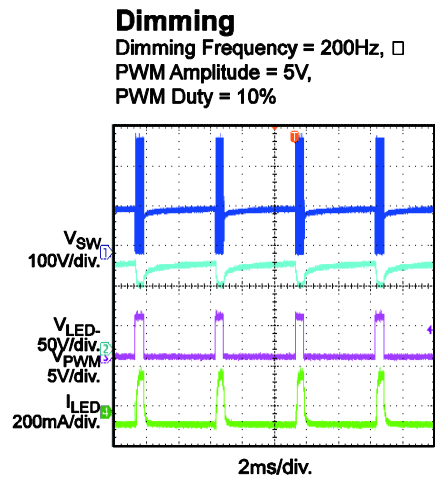
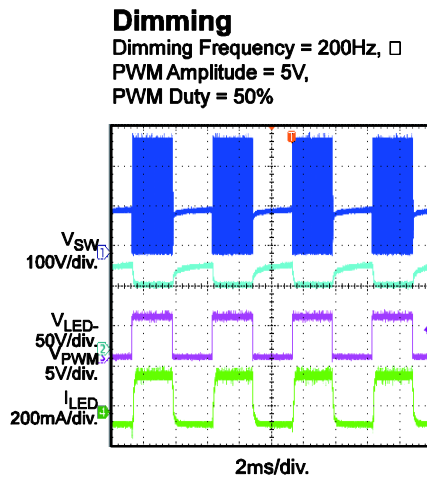
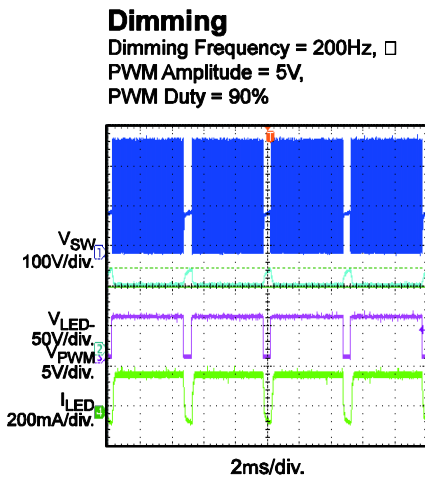
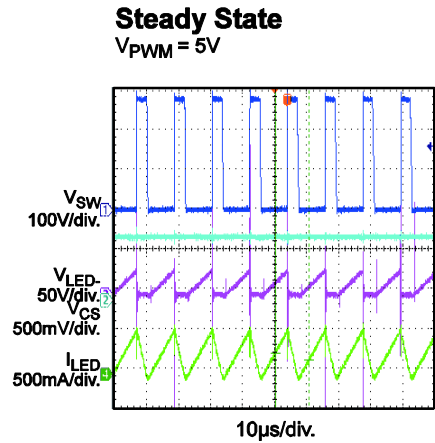
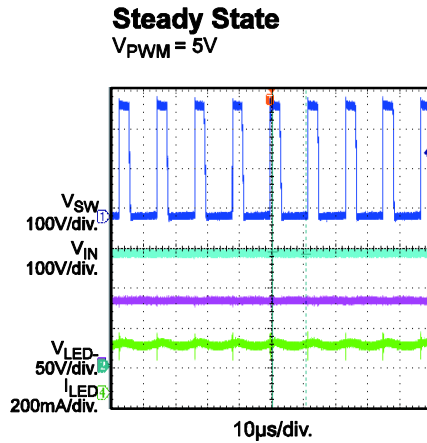
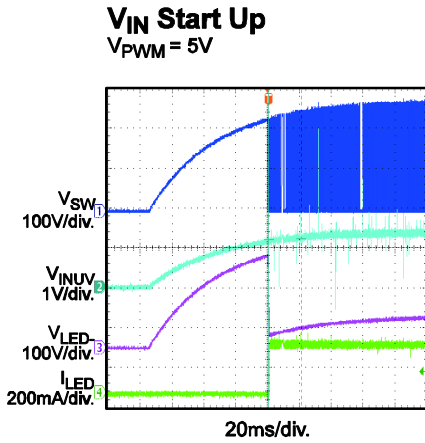

EVB TEST RESULTS *(continued)*

Performance waveforms are tested on the evaluation board.

$V_{IN} = 280V$, $V_{SUPPLY} = 13V$, $V_{LED} = 200V$, $I_{LED} = 250mA$, $T_A = 20^{\circ}C$, unless otherwise noted.

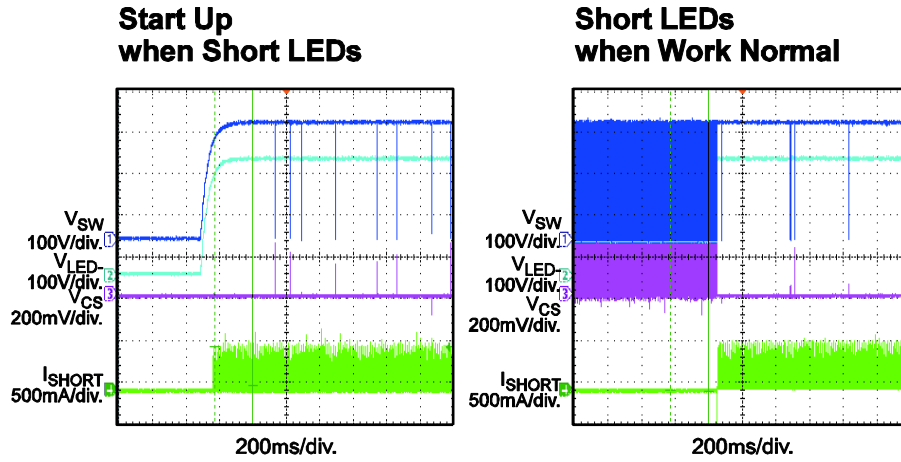

PRINTED CIRCUIT BOARD LAYOUT

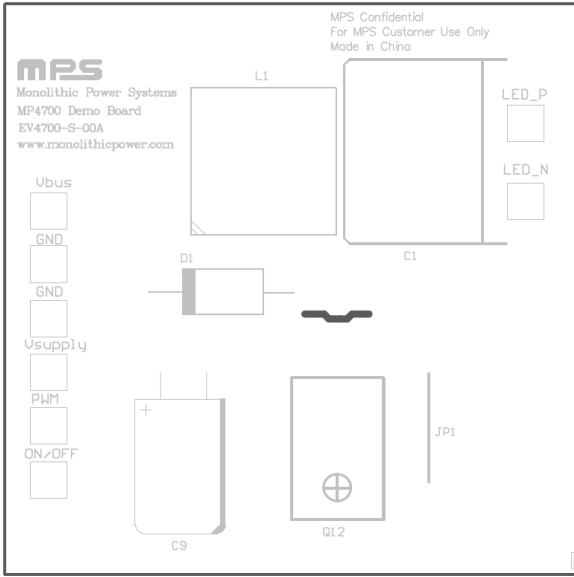

Figure 1—Top Silk Layer

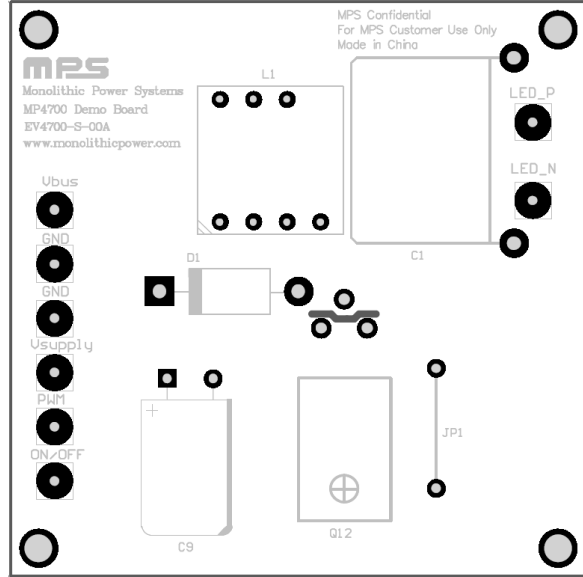

Figure 2—Top Layer

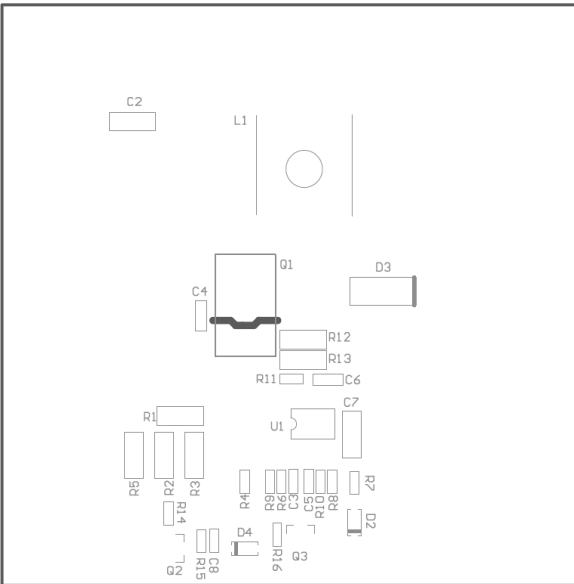

Figure 3—Bottom Silk Layer

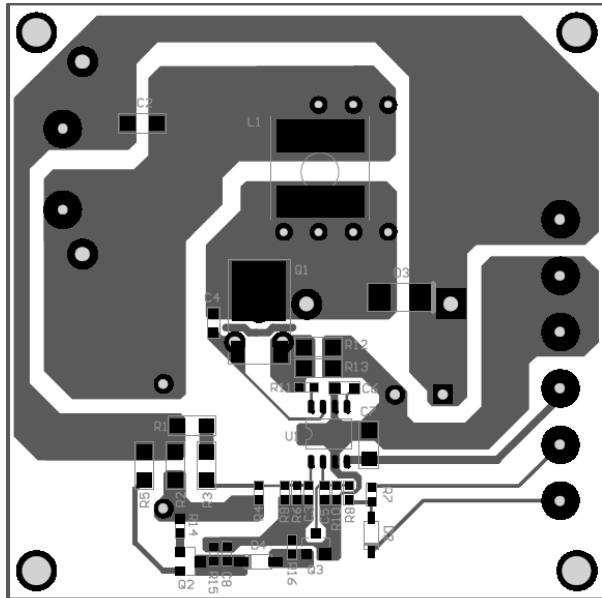

Figure 4—Bottom Layer



QUICK START GUIDE

1. Preset the VIN power supply to 250V-300V, turn off VIN power supply, and connect VIN power supply to “VIN” connector.
2. Preset the IC power supply to 8-18V, turn off the power supply, and connect the IC power supply to “Vsupply” connector.
3. Preset the PWM dimming signal to 5V; turn off the signal, and connect the signal to “PWM” connector.
4. Preset the ON/OFF signal to 2-5V; turn off the signal, and connect the signal to “ON/OFF” connector.
5. Preset the LED string to 200V; connect the anode of LED string to “LED+” and the cathode of LED string to “LED-”.
6. Turn on the VIN power supply.
7. Turn on the IC power supply.
8. Turn on the PWM dimming signal.
9. Turn on the ON/OFF signal, the LED string should be ignited.
10. To demo the PWM dimming performance; set the square wave with amplitude 2-5V, and low level 0V as PWM dimming signal. The duty of LED current will follow the duty of PWM dimming signal.

NOTICE: The information in this document is subject to change without notice. Please contact MPS for current specifications. Users should warrant and guarantee that third party Intellectual Property rights are not infringed upon when integrating MPS products into any application. MPS will not assume any legal responsibility for any said applications.

Looking for pricing, stock, or lifecycle information?

Click below to explore more details on WIN SOURCE:

-  [View EV4700-S-00A on WIN SOURCE](#)
-  [Monolithic Power Systems Inc. Information](#)

Optimize Your Supply Chain with WIN SOURCE Solutions

-  Global Sourcing Solution
-  Obsolete Management
-  Cost Control Management
-  Shortage Management
-  Alternative Solution
-  Excess Inventory Management