



**THE DATASHEET OF
MMH3111NT1**



Heterostructure Field Effect Transistor (GaAs HFET)

Broadband High Linearity Amplifier

The MMH3111NT1 is a general purpose amplifier that is internally input and output prematched. It is designed for a broad range of Class A, small-signal, high linearity, general purpose applications. It is suitable for applications with frequencies from 250 to 4000 MHz such as cellular, PCS, WLL, PHS, CATV, VHF, UHF, UMTS and general small-signal RF.

Features

- Frequency: 250 to 4000 MHz
- P1dB: 22.5 dBm @ 900 MHz
- Small-Signal Gain: 12 dB @ 900 MHz
- Third Order Output Intercept Point: 44 dBm @ 900 MHz
- Single 5 V Supply
- Internally Prematched to 50 Ohms
- Internally Biased
- Cost-effective SOT-89 Surface Mount Plastic Package
- In Tape and Reel. T1 Suffix = 1,000 Units, 12 mm Tape Width, 7-inch Reel.

MMH3111NT1

**250-4000 MHz, 12 dB
22.5 dBm
GaAs HFET GPA**



SOT-89

Table 1. Typical Performance (1)

Characteristic	Symbol	900 MHz	2140 MHz	3500 MHz	Unit
Small-Signal Gain (S21)	G_p	12	11.3	10	dB
Input Return Loss (S11)	IRL	-14	-15	-16	dB
Output Return Loss (S22)	ORL	-14	-19	-14	dB
Power Output @1dB Compression	P1dB	22.5	22	22	dBm
Third Order Output Intercept Point	OIP3	44	44	42	dBm

1. $V_{DD} = 5$ Vdc, $T_A = 25^\circ\text{C}$, 50 ohm system, application circuit tuned for specified frequency.

Table 2. Maximum Ratings

Rating	Symbol	Value	Unit
Supply Voltage	V_{DD}	6	V
Supply Current	I_{DD}	300	mA
RF Input Power	P_{in}	20	dBm
Storage Temperature Range	T_{stg}	-65 to +150	$^\circ\text{C}$
Junction Temperature	T_J	150	$^\circ\text{C}$

Table 3. Thermal Characteristics

Characteristic	Symbol	Value (2)	Unit
Thermal Resistance, Junction to Case Case Temperature 95 $^\circ\text{C}$, 5 Vdc, 150 mA, no RF applied	$R_{\theta JC}$	37.5	$^\circ\text{C/W}$

2. Refer to AN1955, *Thermal Measurement Methodology of RF Power Amplifiers*. Go to <http://www.freescale.com/rf>. Select Documentation/Application Notes - AN1955.

Table 4. Electrical Characteristics ($V_{DD} = 5 \text{ Vdc}$, 900 MHz, $T_A = 25^\circ\text{C}$, 50 ohm system, in Freescale Application Circuit)

Characteristic	Symbol	Min	Typ	Max	Unit
Small-Signal Gain (S21)	G_p	11	12	—	dB
Input Return Loss (S11)	IRL	—	-14	—	dB
Output Return Loss (S22)	ORL	—	-14	—	dB
Power Output @ 1dB Compression	P1dB	—	22.5	—	dBm
Third Order Output Intercept Point	OIP3	—	44	—	dBm
Noise Figure	NF	—	3.2	—	dB
Supply Current	I_{DD}	120	150	190	mA
Supply Voltage	V_{DD}	—	5	—	V

Table 5. Functional Pin Description

Pin Number	Pin Function
1	RF_{in}
2	Ground
3	$RF_{out}/DC \text{ Supply}$

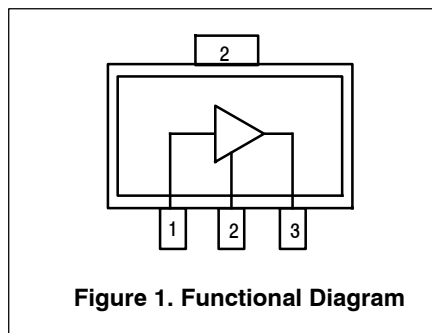

Table 6. ESD Protection Characteristics

Test Methodology	Class
Human Body Model (per JESD 22-A114)	1A
Machine Model (per EIA/JESD 22-A115)	A
Charge Device Model (per JESD 22-C101)	IV

Table 7. Moisture Sensitivity Level

Test Methodology	Rating	Package Peak Temperature	Unit
Per JESD 22-A113, IPC/JEDEC J-STD-020	1	260	$^\circ\text{C}$

50 OHM TYPICAL CHARACTERISTICS

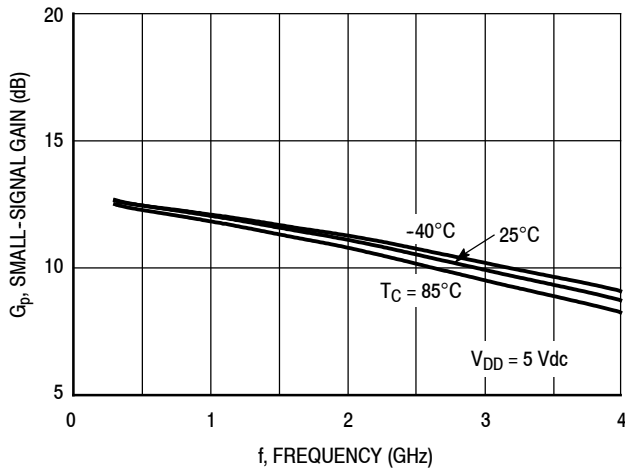

Figure 2. Small-Signal Gain (S21) versus Frequency

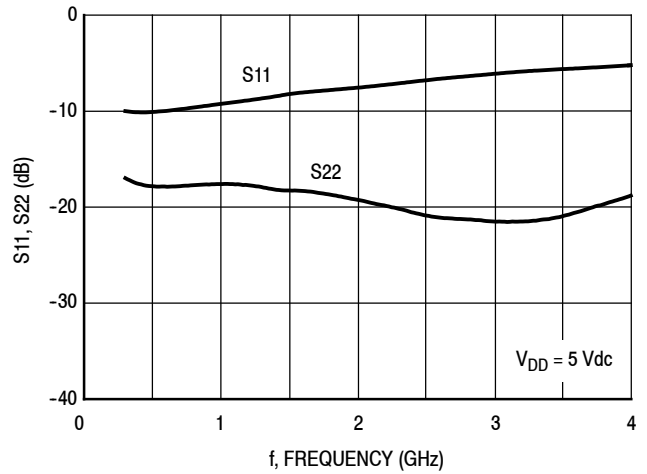

Figure 3. Input/Output Loss versus Frequency

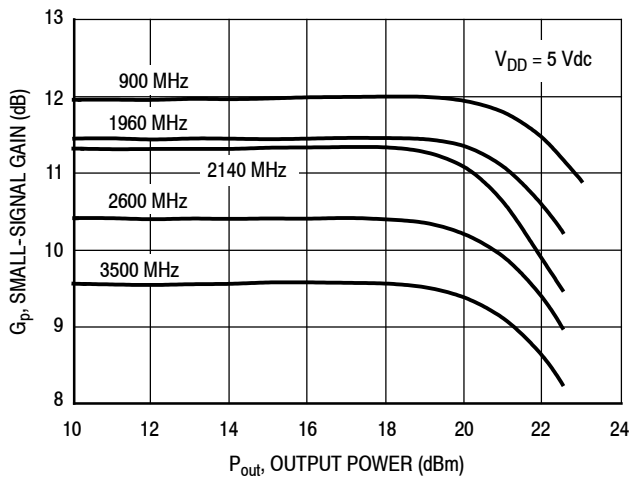

Figure 4. Small-Signal Gain versus Output Power

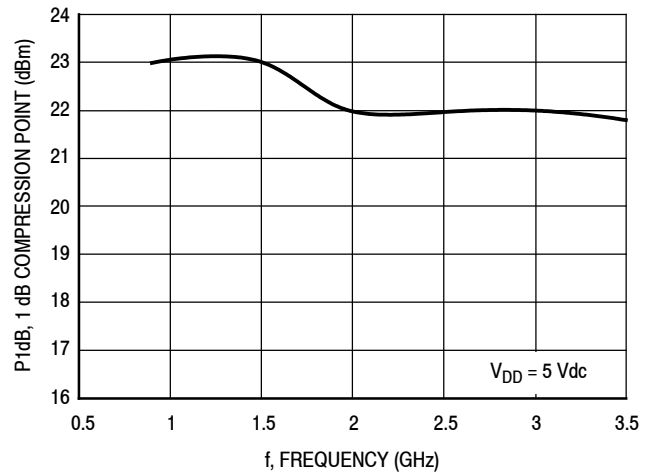

Figure 5. P1dB versus Frequency

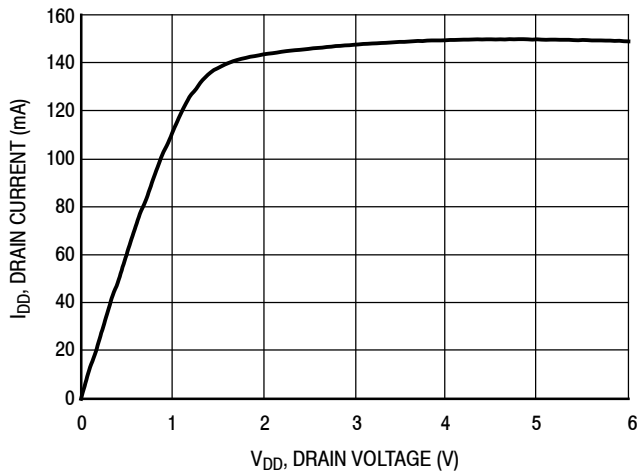

Figure 6. Drain Current versus Drain Voltage

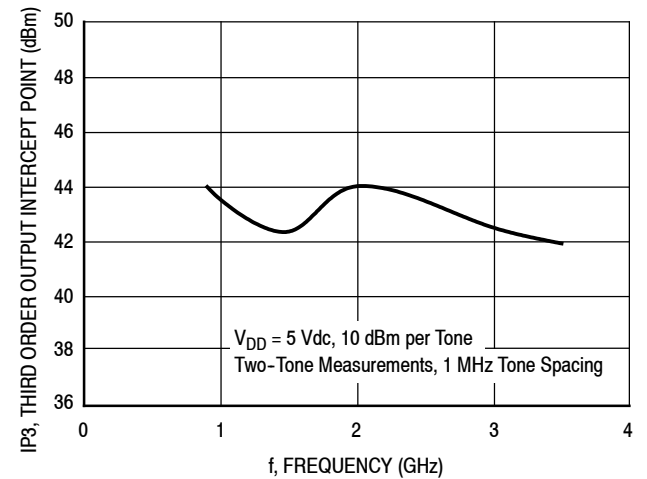

Figure 7. Third Order Output Intercept Point versus Frequency

50 OHM TYPICAL CHARACTERISTICS

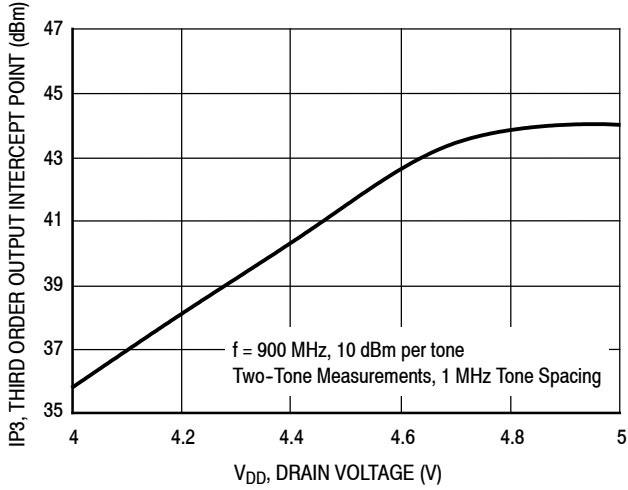

Figure 8. Third Order Output Intercept Point versus Drain Voltage

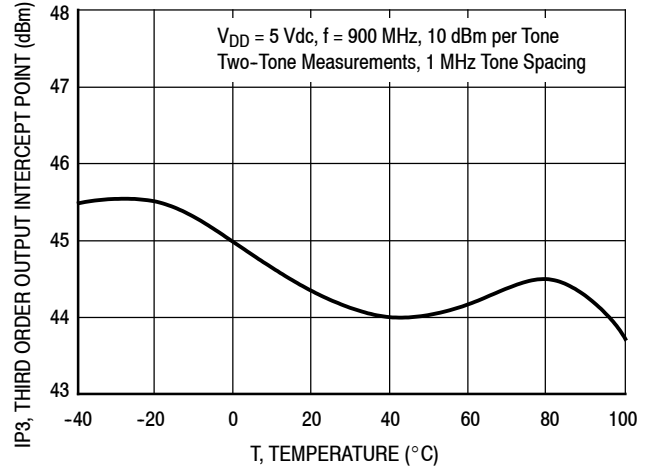

Figure 9. Third Order Output Intercept Point versus Case Temperature

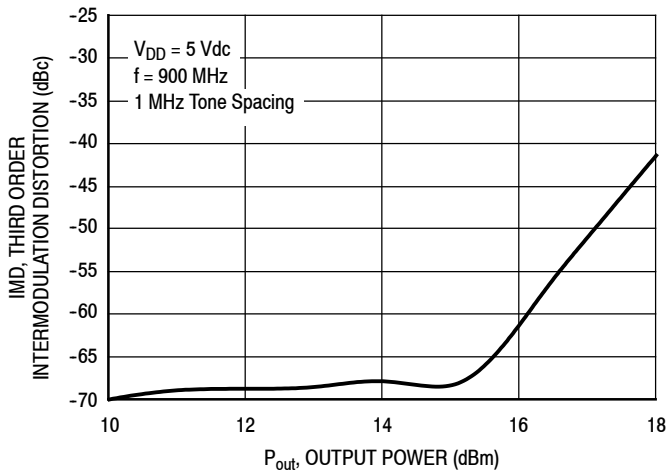

Figure 10. Third Order Intermodulation versus Output Power

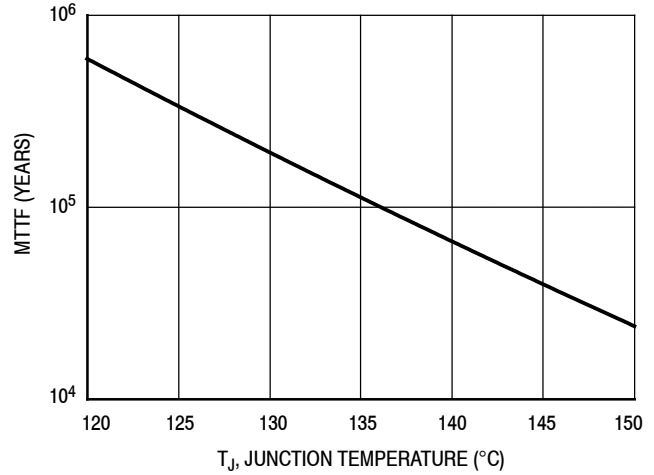

Figure 11. MTTF versus Junction Temperature
NOTE: The MTTF is calculated with $V_{DD} = 5 \text{ Vdc}$, $I_{DD} = 150 \text{ mA}$

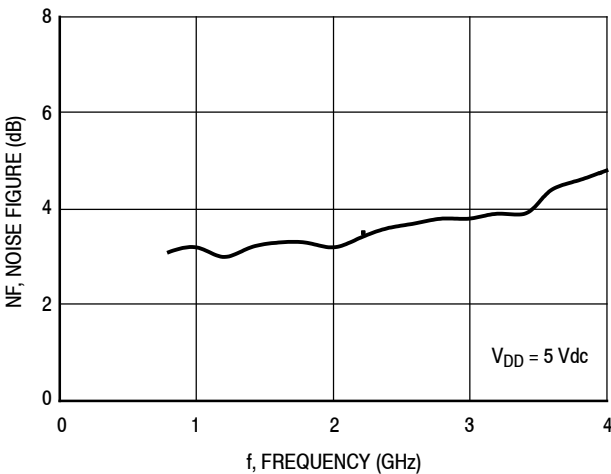

Figure 12. Noise Figure versus Frequency

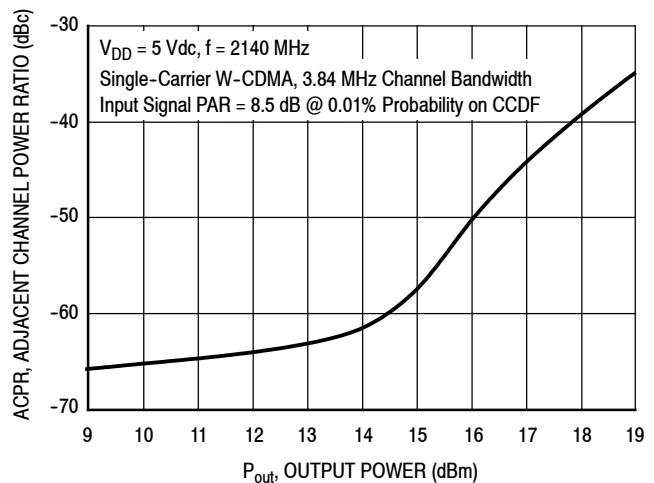
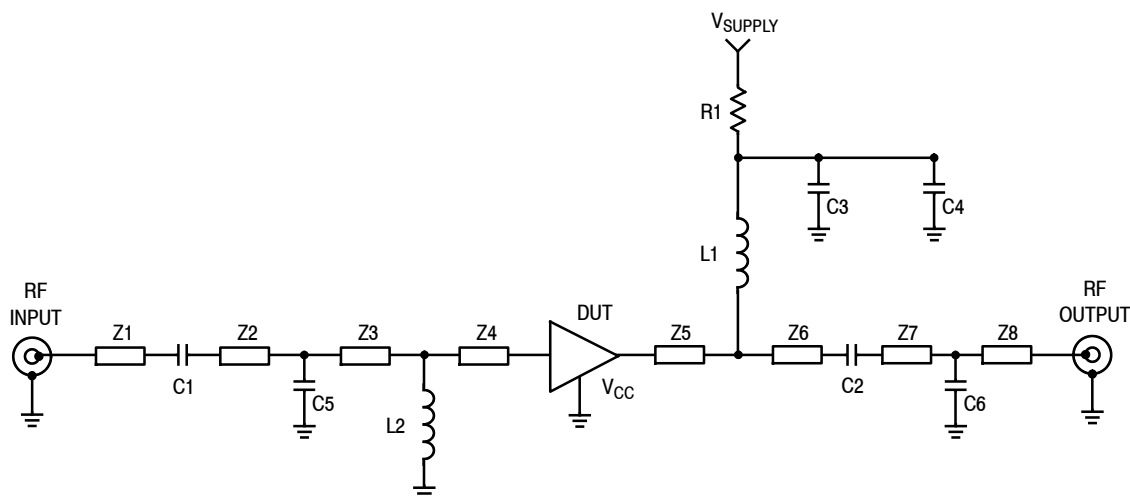

Figure 13. Single-Carrier W-CDMA Adjacent Channel Power Ratio versus Output Power

50 OHM APPLICATION CIRCUIT: 800–1900 MHz



- | | | | |
|----|----------------------------|-----|--|
| Z1 | 0.347" x 0.058" Microstrip | Z6 | 0.403" x 0.058" Microstrip |
| Z2 | 0.068" x 0.058" Microstrip | Z7 | 0.086" x 0.058" Microstrip |
| Z3 | 0.418" x 0.058" Microstrip | Z8 | 0.261" x 0.058" Microstrip |
| Z4 | 0.089" x 0.058" Microstrip | PCB | Getek Grade ML200C, 0.031", $\epsilon_r = 4.1$ |
| Z5 | 0.172" x 0.058" Microstrip | | |

Figure 14. 50 Ohm Test Circuit Schematic

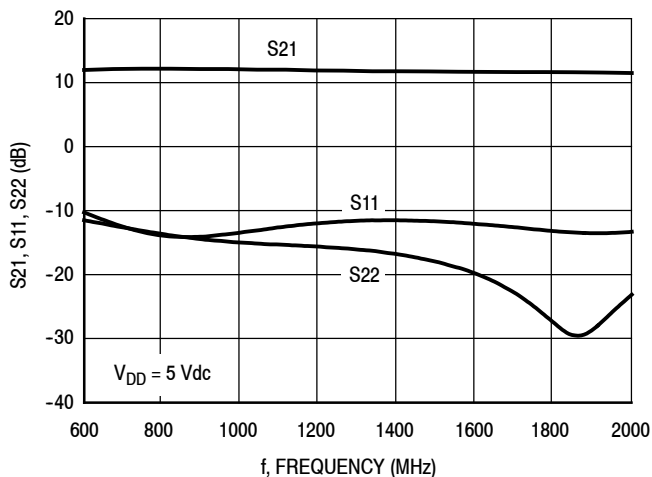

Figure 15. S21, S11 and S22 versus Frequency

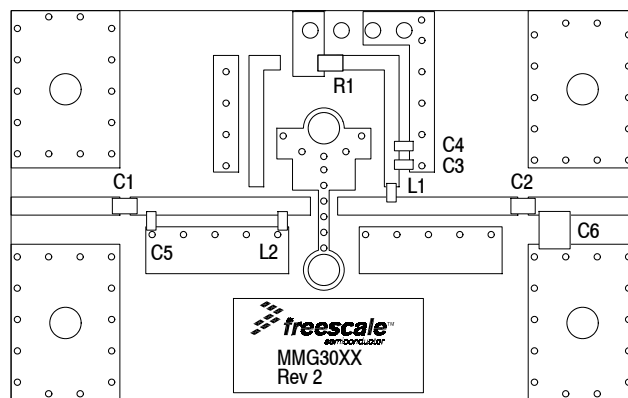

Figure 16. 50 Ohm Test Circuit Component Layout

Table 8. 50 Ohm Test Circuit Component Designations and Values

Part	Description	Part Number	Manufacturer
C1, C2	47 pF Chip Capacitors	06035J470BBS	AVX
C3	0.1 μ F Chip Capacitor	C0603C104J5RAC	Kemet
C4	1 μ F Chip Capacitor	C0603C105J5RAC	Kemet
C5	0.7 pF Chip Capacitor	06035J0R7BBS	AVX
C6	0.4 pF Chip Capacitor	12105J0R4BBS	AVX
L1	56 nH Chip Inductor	HK160856NJ-T	Taiyo Yuden
L2	12 nH Chip Inductor	HK160812NJ-T	Taiyo Yuden
R1	0 Ω , 1/10 W Chip Resistor	CRCW06030000FKEA	Vishay

50 OHM APPLICATION CIRCUIT: 1900-2200 MHz

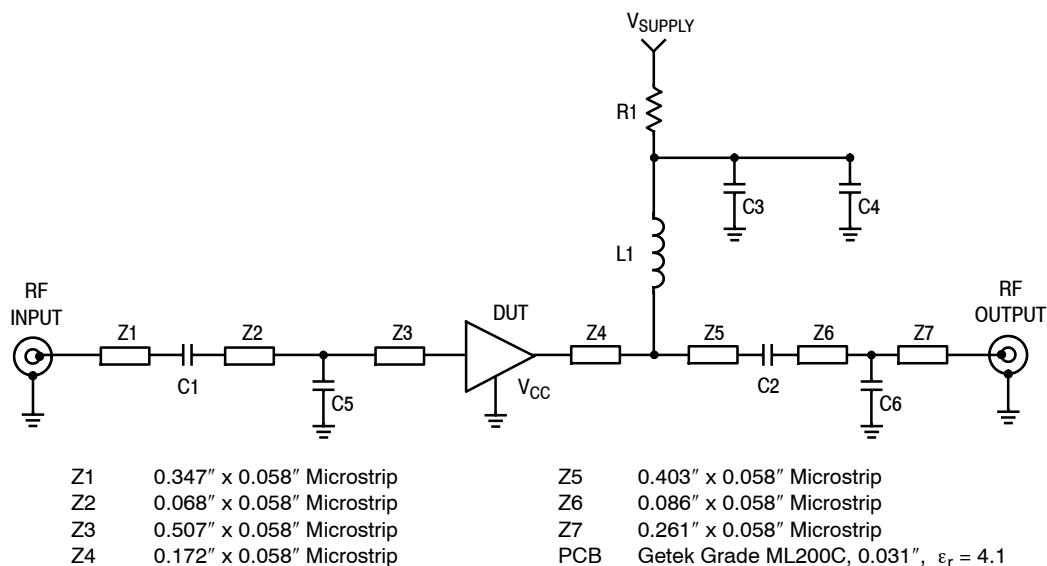

Figure 17. 50 Ohm Test Circuit Schematic

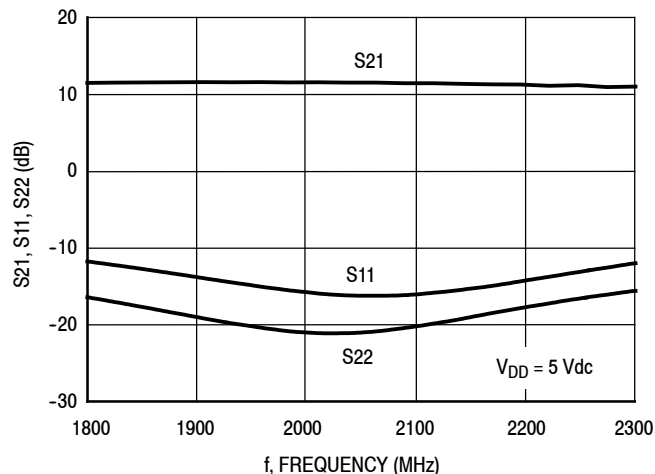

Figure 18. S21, S11 and S22 versus Frequency

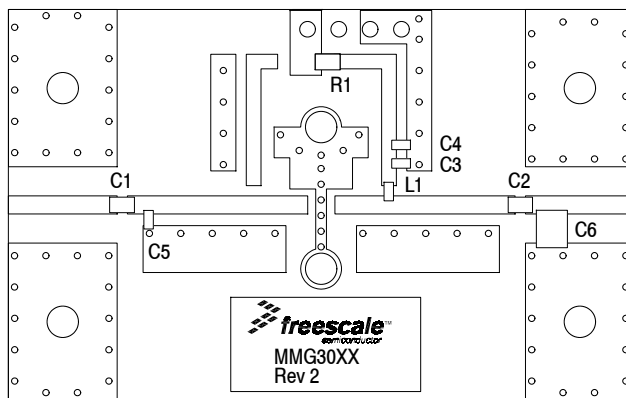

Figure 19. 50 Ohm Test Circuit Component Layout

Table 9. 50 Ohm Test Circuit Component Designations and Values

Part	Description	Part Number	Manufacturer
C1, C2	0.01 μ F Chip Capacitors	06035J470BBS	AVX
C3	0.1 μ F Chip Capacitor	C0603C104J5RAC	Kemet
C4	1 μ F Chip Capacitor	C0603C105J5RAC	Kemet
C5	0.7 pF Chip Capacitor	06035J0R7BBS	AVX
C6	0.4 pF Chip Capacitor	12105J0R4BBS	AVX
L1	56 nH Chip Inductor	HK160856NJ-T	Taiyo Yuden
R1	0 Ω , 1/10 W Chip Resistor	CRCW06030000FKEA	Vishay

50 OHM APPLICATION CIRCUIT: 2500-3800 MHz

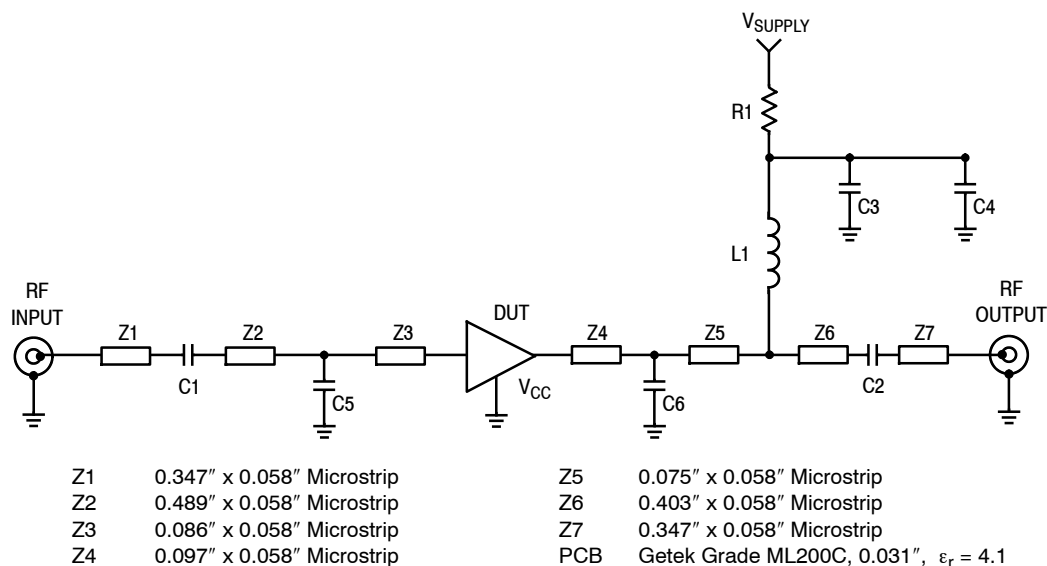

Figure 20. 50 Ohm Test Circuit Schematic

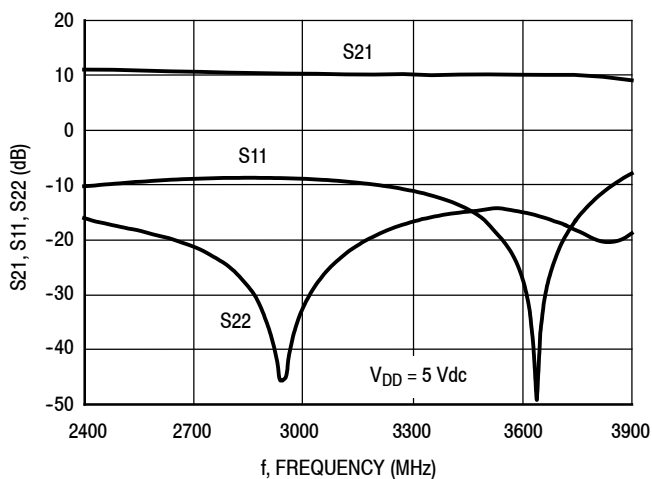

Figure 21. S21, S11 and S22 versus Frequency

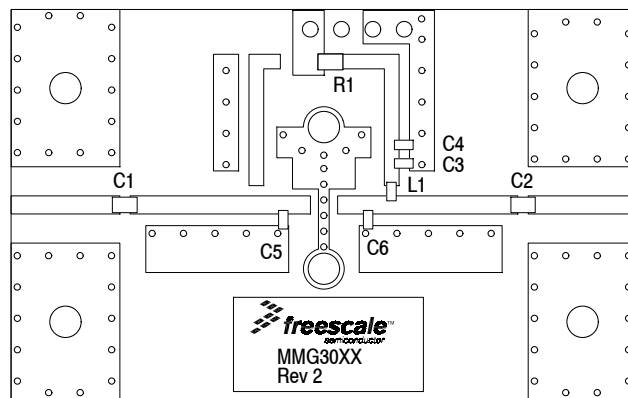

Figure 22. 50 Ohm Test Circuit Component Layout

Table 10. 50 Ohm Test Circuit Component Designations and Values

Part	Description	Part Number	Manufacturer
C1, C2	2 pF Chip Capacitors	06035J2R0BBS	AVX
C3	0.1 μ F Chip Capacitor	C0603C104J5RAC	Kemet
C4	1 μ F Chip Capacitor	C0603C105J5RAC	Kemet
C5	0.8 pF Chip Capacitor	06035J0R8BBS	AVX
C6	0.4 pF Chip Capacitor	06035J0R4BBS	AVX
L1	56 nH Chip Inductor	HK160856NJ-T	Taiyo Yuden
R1	0 Ω , 1/10 W Chip Resistor	CRCW06030000FKEA	Vishay

50 OHM TYPICAL CHARACTERISTICS

Table 11. Common Source S-Parameters ($V_{DD} = 5 \text{ Vdc}$, $T_A = 25^\circ\text{C}$, 50 Ohm System)

f MHz	S ₁₁		S ₂₁		S ₁₂		S ₂₂	
	S ₁₁	∠ φ	S ₂₁	∠ φ	S ₁₂	∠ φ	S ₂₂	∠ φ
100	0.329	-36.383	4.365	165.300	0.116	4.544	0.161	-47.926
150	0.324	-37.554	4.337	163.880	0.116	3.571	0.154	-47.482
250	0.322	-38.791	4.313	162.387	0.116	2.612	0.147	-46.993
300	0.318	-40.072	4.288	160.990	0.116	1.903	0.143	-46.565
350	0.315	-41.580	4.266	159.673	0.116	1.012	0.137	-46.090
400	0.313	-43.457	4.239	158.172	0.116	0.371	0.133	-45.522
450	0.313	-45.793	4.217	156.531	0.116	-1.047	0.130	-45.093
500	0.315	-48.163	4.196	154.804	0.116	-2.355	0.129	-44.795
550	0.317	-50.730	4.175	153.014	0.117	-3.521	0.129	-45.225
600	0.319	-53.308	4.154	151.195	0.117	-4.643	0.129	-45.763
650	0.322	-55.918	4.136	149.346	0.117	-5.686	0.129	-46.206
700	0.325	-58.706	4.116	147.439	0.117	-6.700	0.129	-46.966
750	0.329	-61.512	4.098	145.565	0.117	-7.693	0.130	-47.749
800	0.332	-64.233	4.078	143.660	0.117	-8.616	0.131	-48.671
850	0.336	-67.096	4.059	141.719	0.117	-9.581	0.132	-49.880
900	0.339	-69.960	4.040	139.799	0.117	-10.489	0.132	-51.046
950	0.344	-72.823	4.019	137.852	0.117	-11.398	0.133	-52.269
1000	0.347	-75.724	4.001	135.896	0.117	-12.312	0.133	-53.492
1050	0.351	-78.553	3.983	133.947	0.118	-13.198	0.133	-54.989
1100	0.355	-81.424	3.964	131.996	0.118	-14.093	0.132	-56.508
1150	0.358	-84.459	3.944	130.038	0.118	-14.998	0.131	-57.950
1200	0.362	-87.372	3.924	128.069	0.118	-15.903	0.131	-59.716
1250	0.367	-90.300	3.903	126.129	0.118	-16.821	0.129	-61.319
1300	0.371	-93.201	3.883	124.163	0.118	-17.713	0.128	-63.068
1350	0.375	-96.015	3.861	122.219	0.118	-18.623	0.126	-64.878
1400	0.380	-98.765	3.837	120.287	0.118	-19.497	0.124	-66.432
1450	0.385	-101.218	3.815	118.370	0.118	-20.349	0.123	-67.493
1500	0.391	-103.291	3.793	116.530	0.118	-21.202	0.123	-68.218
1550	0.395	-105.591	3.773	114.664	0.119	-22.024	0.123	-69.287
1600	0.398	-108.116	3.752	112.769	0.119	-22.896	0.122	-70.746
1650	0.401	-110.631	3.731	110.886	0.119	-23.793	0.121	-72.539
1700	0.404	-113.324	3.710	108.972	0.119	-24.719	0.120	-74.765
1750	0.407	-116.074	3.691	107.070	0.119	-25.638	0.118	-77.175
1800	0.410	-118.856	3.672	105.143	0.119	-26.594	0.117	-79.613
1850	0.413	-121.692	3.654	103.215	0.119	-27.518	0.115	-82.165
1900	0.416	-124.469	3.633	101.291	0.119	-28.483	0.113	-84.722
1950	0.419	-127.201	3.613	99.367	0.120	-29.461	0.111	-87.462
2000	0.422	-130.044	3.592	97.431	0.120	-30.414	0.110	-90.359
2050	0.425	-132.901	3.570	95.510	0.120	-31.362	0.108	-93.223
2100	0.428	-135.666	3.547	93.588	0.120	-32.353	0.106	-96.005
2150	0.432	-138.396	3.525	91.656	0.120	-33.317	0.104	-99.124
2160	0.433	-138.893	3.519	91.287	0.120	-33.518	0.104	-99.644
2170	0.434	-139.420	3.515	90.904	0.120	-33.707	0.103	-100.212
2180	0.434	-139.934	3.509	90.532	0.120	-33.908	0.103	-100.854
2190	0.435	-140.473	3.506	90.142	0.120	-34.094	0.103	-101.491

(continued)

50 OHM TYPICAL CHARACTERISTICS

Table 11. Common Source S-Parameters ($V_{DD} = 5 \text{ Vdc}$, $T_A = 25^\circ\text{C}$, 50 Ohm System) (continued)

f MHz	S ₁₁		S ₂₁		S ₁₂		S ₂₂	
	S ₁₁	∠ φ	S ₂₁	∠ φ	S ₁₂	∠ φ	S ₂₂	∠ φ
2200	0.436	-141.015	3.502	89.764	0.120	-34.293	0.102	-102.102
2250	0.440	-143.664	3.480	87.853	0.120	-35.279	0.100	-105.319
2300	0.444	-146.130	3.456	85.964	0.120	-36.278	0.099	-108.673
2350	0.448	-148.573	3.433	84.098	0.120	-37.227	0.097	-111.868
2400	0.452	-150.891	3.408	82.262	0.120	-38.193	0.094	-115.093
2450	0.457	-153.231	3.384	80.399	0.120	-39.165	0.093	-118.343
2500	0.461	-155.588	3.360	78.562	0.120	-40.131	0.091	-121.666
2550	0.465	-157.929	3.337	76.708	0.120	-41.119	0.090	-125.028
2600	0.469	-160.182	3.312	74.886	0.120	-42.109	0.089	-128.277
2650	0.473	-162.557	3.290	73.042	0.120	-43.087	0.088	-131.582
2700	0.476	-164.863	3.268	71.221	0.120	-44.100	0.088	-134.657
2750	0.480	-167.206	3.246	69.393	0.120	-45.119	0.087	-137.722
2800	0.483	-169.520	3.223	67.572	0.120	-46.143	0.087	-140.631
2850	0.487	-171.820	3.201	65.747	0.120	-47.132	0.086	-143.444
2900	0.490	-173.992	3.180	63.945	0.120	-48.134	0.086	-146.347
2950	0.494	-176.195	3.157	62.155	0.120	-49.132	0.085	-149.433
3000	0.498	-178.278	3.136	60.357	0.120	-50.131	0.085	-152.745
3050	0.501	179.789	3.114	58.599	0.120	-51.092	0.085	-156.274
3100	0.505	177.950	3.092	56.836	0.120	-52.074	0.084	-160.030
3150	0.508	176.155	3.071	55.112	0.120	-53.076	0.085	-163.912
3200	0.511	174.401	3.051	53.377	0.120	-54.062	0.085	-167.662
3250	0.514	172.667	3.031	51.656	0.120	-55.020	0.085	-171.336
3300	0.517	170.842	3.010	49.907	0.120	-55.996	0.086	-175.010
3350	0.519	169.000	2.990	48.184	0.120	-56.970	0.087	-178.505
3400	0.522	167.181	2.970	46.458	0.120	-57.975	0.087	177.850
3450	0.524	165.308	2.950	44.716	0.120	-59.010	0.089	174.447
3500	0.527	163.438	2.930	43.003	0.120	-60.024	0.090	170.925
3550	0.528	161.590	2.911	41.291	0.120	-61.051	0.093	167.846
3600	0.531	159.691	2.892	39.560	0.120	-62.060	0.095	164.966

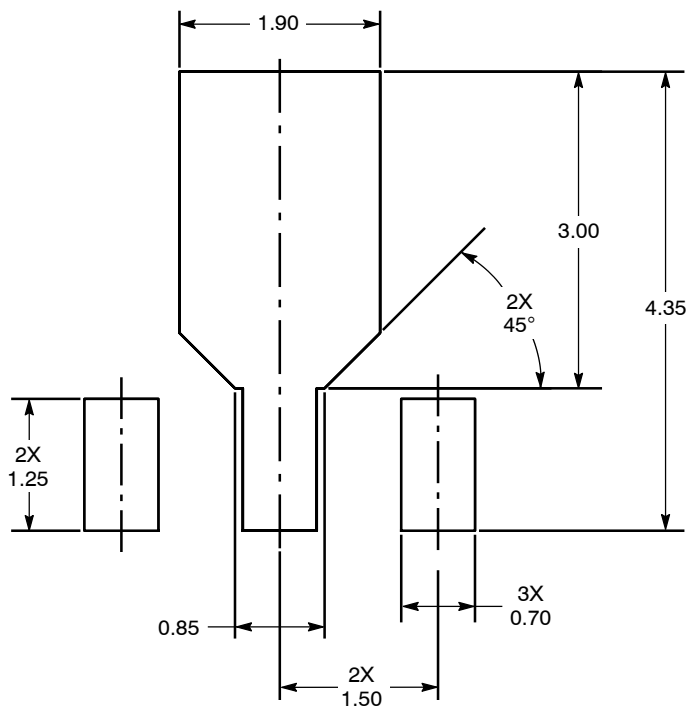

Figure 23. PCB Pad Layout for SOT-89A

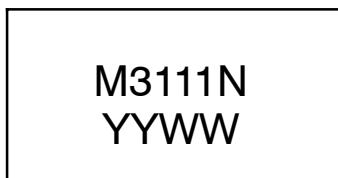
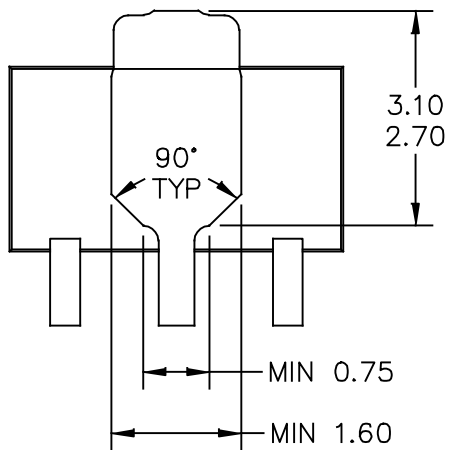

Figure 24. Product Marking



BOTTOM VIEW

© FREESCALE SEMICONDUCTOR, INC. ALL RIGHTS RESERVED.	MECHANICAL OUTLINE	PRINT VERSION NOT TO SCALE	
TITLE: SOT-89A, 3 LEAD, 4.5 X 2.5 PKG, 1.5 MM PITCH		DOCUMENT NO: 98ASA00241D	REV: 0
		CASE NUMBER: 2142-01	15 JUL 2010
		STANDARD: NON-JEDEC	

NOTES:

1. DIMENSIONING AND TOLERANCING PER ASME Y14.5M – 1994.
2. ALL DIMENSIONS ARE IN MILLIMETERS.

3. DIMENSIONS DOES NOT INCLUDE MOLD FLASH. PROTRUSIONS OR GATE BURRS. MOLD FLASH, PROTRUSIONS OR GATE BURRS SHALL NOT EXCEED 0.5 MM PER END. DIMENSION DOES NOT INCLUDE INTERLEAD FLASH OR PROTRUSION. INTERLEAD FLASH OR PROTRUSION SHALL NOT EXCEED 0.5 MM PER SIDE.

4. DIMENSION ARE DETERMINED AT THE OUTMOST EXTREMES OF THE PLASTIC BODY EXCLUSIVE OF MOLD FLASH, TIE BAR BURRS, GATE BURRS AND INTERLEAD FLASH, BUT INCLUDING ANY MISMATCH BETWEEN THE TOP AND BOTTOM OF THE PLASTIC BODY.

5. TERMINAL NUMBERS ARE SHOWN FOR REFERENCE ONLY.

© FREESCALE SEMICONDUCTOR, INC. ALL RIGHTS RESERVED.	MECHANICAL OUTLINE	PRINT VERSION NOT TO SCALE	
TITLE: SOT-89A, 3 LEAD, 4.5 X 2.5 PKG, 1.5 MM PITCH		DOCUMENT NO: 98ASA00241D	REV: 0
		CASE NUMBER: 2142-01	15 JUL 2010
		STANDARD: NON-JEDEC	

Refer to the following resources to aid your design process.

Application Notes

- AN1955: Thermal Measurement Methodology of RF Power Amplifiers
- AN3100: General Purpose Amplifier and MMIC Biasing

Software

- .s2p File

Development Tools

- Printed Circuit Boards

For Software and Tools, do a Part Number search at <http://www.freescale.com>, and select the “Part Number” link. Go to Software & Tools on the part’s Product Summary page to download the respective tool.

REVISION HISTORY

The following table summarizes revisions to this document.

Revision	Date	Description
0	Nov. 2007	<ul style="list-style-type: none"> • Initial Release of Data Sheet
1	Apr. 2008	<ul style="list-style-type: none"> • Removed Footnote 2, Continuous voltage and current applied to device, from Table 2, Maximum Ratings, p. 1 • Corrected Fig. 13, Single-Carrier W-CDMA Adjacent Channel Power Ratio versus Output Power y-axis (ACPR) unit of measure to dBc, p. 5 • Updated Part Numbers in Tables 8, 9, 10, Component Designations and Values, to latest RoHS compliant part numbers, pp. 6, 7, 8
2	Apr. 2010	<ul style="list-style-type: none"> • Changed Maximum Ratings table value for RF input power from 10 to 20 dBm as a result of improvements made in the measurement method and the capability of the device, p. 1 • Added .s2p File availability to Product Software, p. 15
3	Jan. 2011	<ul style="list-style-type: none"> • Corrected temperature at which Theta_{JC} is measured from 25°C to 95°C and added “no RF applied” to Thermal Characteristics table to indicate that thermal characterization is performed under DC test with no RF signal applied, p. 1 • Removed I_{DD} bias callout from applicable graphs as bias is not a controlled value, pp. 4-8 • Removed I_{DD} bias callout from Table 11, Common Source S-Parameters heading as bias is not a controlled value, pp. 9-10 • Added Printed Circuit Boards availability to Development Tools, p. 15
4	Sept. 2012	<ul style="list-style-type: none"> • Replaced the PCB Pad Layout drawing, the package isometric and mechanical outline for Case 1514-02 (SOT-89) with Case 2142-01 (SOT-89) as a result of the device transfer from a Freescale wafer fab to an external GaAs wafer fab and new assembly site. The new assembly and test site’s SOT-89 package has slight dimensional differences, pp. 1, 11-14. Refer to PCN13337, <i>GaAs Fab Transfer</i>. • Table 6, ESD Protection Characteristics, removed the word “Minimum” after the ESD class rating. ESD ratings are characterized during new product development but are not 100% tested during production. ESD ratings provided in the data sheet are intended to be used as a guideline when handling ESD sensitive devices, p. 3 • Added Fig. 24, Product Marking, p. 11 • Added AN3100, General Purpose Amplifier and MMIC Biasing to Product Documentation, Application Notes, p. 15
4.1	Oct. 2014	<ul style="list-style-type: none"> • Revised Fig. 24, Product Marking, p. 10

How to Reach Us:

Home Page:
freescale.com

Web Support:
freescale.com/support

Information in this document is provided solely to enable system and software implementers to use Freescale products. There are no express or implied copyright licenses granted hereunder to design or fabricate any integrated circuits based on the information in this document.



Freescale reserves the right to make changes without further notice to any products herein. Freescale makes no warranty, representation, or guarantee regarding the suitability of its products for any particular purpose, nor does Freescale assume any liability arising out of the application or use of any product or circuit, and specifically disclaims any and all liability, including without limitation consequential or incidental damages. "Typical" parameters that may be provided in Freescale data sheets and/or specifications can and do vary in different applications, and actual performance may vary over time. All operating parameters, including "typicals," must be validated for each customer application by customer's technical experts. Freescale does not convey any license under its patent rights nor the rights of others. Freescale sells products pursuant to standard terms and conditions of sale, which can be found at the following address: freescale.com/SalesTermsandConditions.

Freescale and the Freescale logo are trademarks of Freescale Semiconductor, Inc., Reg. U.S. Pat. & Tm. Off. All other product or service names are the property of their respective owners.

© 2007-2008, 2010-2012, 2014 Freescale Semiconductor, Inc.

Looking for pricing, stock, or lifecycle information?

Click below to explore more details on WIN SOURCE:

-  [View MMH3111NT1 on WIN SOURCE](#)
-  [NXP / Nexperia Information](#)

Optimize Your Supply Chain with WIN SOURCE Solutions

-  Global Sourcing Solution
-  Obsolete Management
-  Cost Control Management
-  Shortage Management
-  Alternative Solution
-  Excess Inventory Management