



**THE DATASHEET OF  
MCF12102H500-T**



## Notice for TAIYO YUDEN products

Please read this notice before using the TAIYO YUDEN products.

### ⚠️ REMINDERS

#### ■ Product Information in this Catalog

Product information in this catalog is as of January 2021. All of the contents specified herein and production status of the products listed in this catalog are subject to change without notice due to technical improvement of our products, etc. Therefore, please check for the latest information carefully before practical application or use of our products.

Please note that TAIYO YUDEN shall not be in any way responsible for any damages and defects in products or equipment incorporating our products, which are caused under the conditions other than those specified in this catalog or individual product specification sheets.

#### ■ Approval of Product Specifications

Please contact TAIYO YUDEN for further details of product specifications as the individual product specification sheets are available. When using our products, please be sure to approve our product specifications or make a written agreement on the product specification with TAIYO YUDEN in advance.

#### ■ Pre-Evaluation in the Actual Equipment and Conditions

Please conduct validation and verification of our products in actual conditions of mounting and operating environment before using our products.

#### ■ Limited Application

##### 1. Equipment Intended for Use

The products listed in this catalog are intended for general-purpose and standard use in general electronic equipment (e.g., AV equipment, OA equipment, home electric appliances, office equipment, information and communication equipment including, without limitation, mobile phone, and PC) and other equipment specified in this catalog or the individual product specification sheets.

TAIYO YUDEN has the line-up of the products intended for use in automotive electronic equipment, telecommunications infrastructure and industrial equipment, or medical devices classified as GHTF Classes A to C (Japan Classes I to III). Therefore, when using our products for these equipment, please check available applications specified in this catalog or the individual product specification sheets and use the corresponding products.

##### 2. Equipment Requiring Inquiry

Please be sure to contact TAIYO YUDEN for further information before using the products listed in this catalog for the following equipment (excluding intended equipment as specified in this catalog or the individual product specification sheets) which may cause loss of human life, bodily injury, serious property damage and/or serious public impact due to a failure or defect of the products and/or malfunction attributed thereto.

- (1) Transportation equipment (automotive powertrain control system, train control system, and ship control system, etc.)
- (2) Traffic signal equipment
- (3) Disaster prevention equipment, crime prevention equipment
- (4) Medical devices classified as GHTF Class C (Japan Class III)
- (5) Highly public information network equipment, data-processing equipment (telephone exchange, and base station, etc.)
- (6) Any other equipment requiring high levels of quality and/or reliability equal to the equipment listed above

##### 3. Equipment Prohibited for Use

Please do not incorporate our products into the following equipment requiring extremely high levels of safety and/or reliability.

- (1) Aerospace equipment (artificial satellite, rocket, etc.)
- (2) Aviation equipment \*<sup>1</sup>
- (3) Medical devices classified as GHTF Class D (Japan Class IV), implantable medical devices \*<sup>2</sup>

- (4) Power generation control equipment (nuclear power, hydroelectric power, thermal power plant control system, etc.)
- (5) Undersea equipment (submarine repeating equipment, underwater work equipment, etc.)
- (6) Military equipment
- (7) Any other equipment requiring extremely high levels of safety and/or reliability equal to the equipment listed above

\*Notes:

1. There is a possibility that our products can be used only for aviation equipment that does not directly affect the safe operation of aircraft (e.g., in-flight entertainment, cabin light, electric seat, cooking equipment) if such use meets requirements specified separately by TAIYO YUDEN. Please be sure to contact TAIYO YUDEN for further information before using our products for such aviation equipment.
2. Implantable medical devices contain not only internal unit which is implanted in a body, but also external unit which is connected to the internal unit.

#### 4. Limitation of Liability

Please note that unless you obtain prior written consent of TAIYO YUDEN, TAIYO YUDEN shall not be in any way responsible for any damages incurred by you or third parties arising from use of the products listed in this catalog for any equipment that is not intended for use by TAIYO YUDEN, or any equipment requiring inquiry to TAIYO YUDEN or prohibited for use by TAIYO YUDEN as described above.

#### ■ Safety Design

When using our products for high safety and/or reliability-required equipment or circuits, please fully perform safety and/or reliability evaluation. In addition, please install (i) systems equipped with a protection circuit and a protection device and/or (ii) systems equipped with a redundant circuit or other system to prevent an unsafe status in the event of a single fault for a failsafe design to ensure safety.

#### ■ Intellectual Property Rights

Information contained in this catalog is intended to convey examples of typical performances and/or applications of our products and is not intended to make any warranty with respect to the intellectual property rights or any other related rights of TAIYO YUDEN or any third parties nor grant any license under such rights.

#### ■ Limited Warranty

Please note that the scope of warranty for our products is limited to the delivered our products themselves and TAIYO YUDEN shall not be in any way responsible for any damages resulting from a failure or defect in our products. Notwithstanding the foregoing, if there is a written agreement (e.g., supply and purchase agreement, quality assurance agreement) signed by TAIYO YUDEN and your company, TAIYO YUDEN will warrant our products in accordance with such agreement.

#### ■ TAIYO YUDEN's Official Sales Channel

The contents of this catalog are applicable to our products which are purchased from our sales offices or authorized distributors (hereinafter "TAIYO YUDEN's official sales channel"). Please note that the contents of this catalog are not applicable to our products purchased from any seller other than TAIYO YUDEN's official sales channel.

#### ■ Caution for Export

Some of our products listed in this catalog may require specific procedures for export according to "U.S. Export Administration Regulations", "Foreign Exchange and Foreign Trade Control Law" of Japan, and other applicable regulations. Should you have any questions on this matter, please contact our sales staff.

▶ This catalog contains the typical specification only due to the limitation of space. When you consider the purchase of our products, please check our product specification sheets. For details of each product (characteristics graph, reliability information, precautions for use, and so on), see our website (<http://www.ty-top.com/>).

# SMD COMMON MODE CHOKE COILS FOR DC AND SIGNAL LINES

REFLOW

■ PARTS NUMBER

\*Operating Temp. : -25~+105°C (Including self-generated heat)

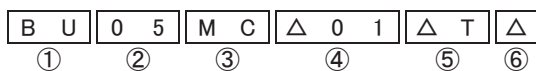

△=Blank space

①Series name

Code	Series name
BU	Common mode choke coil

④Product classification code

Code	Product classification code
△01~△10	Product classification code

②Dimensions of core

Code	Dimensions of core [mm]
05	5.0

⑤Packaging

Code	Packaging
△T	Taping

③Shape

Code	Shape
MC	Surface mount type

⑥Internal code

Code	Internal code
△	Standard

■ STANDARD EXTERNAL DIMENSIONS / MINIMUM QUANTITY

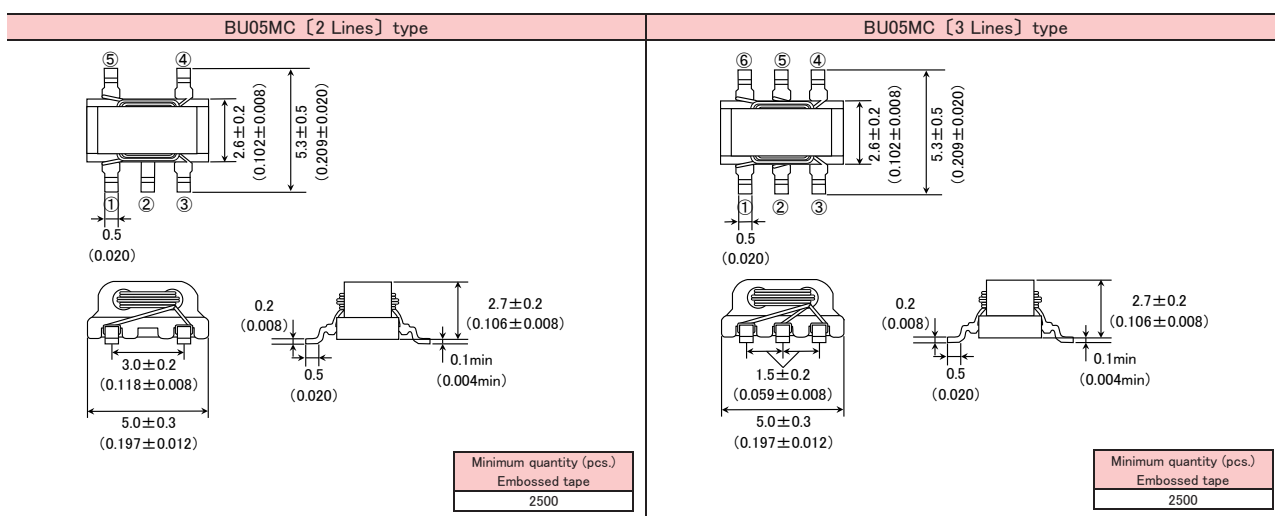

The values without tolerance are for reference only.

■ PARTS NUMBER

Parts number	EHS	Number of lines	Impedance [Ω] (typ.)	Measuring frequency [MHz]	DC Resistance [Ω] (max.)	Rated current [A] (max.)	Rated voltage [V] (D.C.)	Insulation resistance [MΩ] (min.)
BU05MC 01 T	RoHS	2	1000	60	0.12	1.0	50	100
BU05MC 08 T	RoHS	3	700	60	0.11	0.5	50	100

▶ This catalog contains the typical specification only due to the limitation of space. When you consider the purchase of our products, please check our product specification sheets. For details of each product (characteristics graph, reliability information, precautions for use, and so on), see our website (<http://www.ty-top.com/>).

# SMD COMMON MODE CHOKE COILS FOR DC AND SIGNAL LINES, BALUN TRANSFORMERS

## PACKAGING

### ① Minimum Quantity

Type	Minimum Quantity [pcs]	
	Box	Taping
BU05MC	—	2500
BU06MB	150	—

### ② Tape material

#### ● Embossed Tape

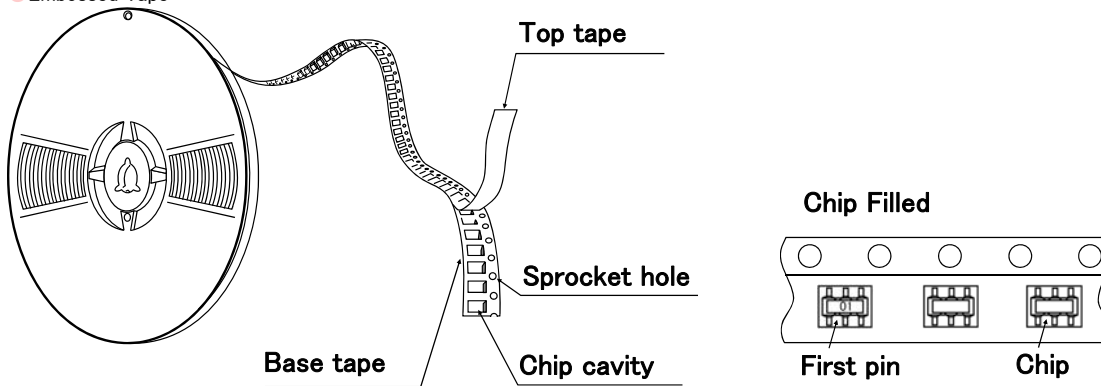

### ③ Taping dimensions

#### ● Embossed tape 12mm wide (0.472 inches wide)

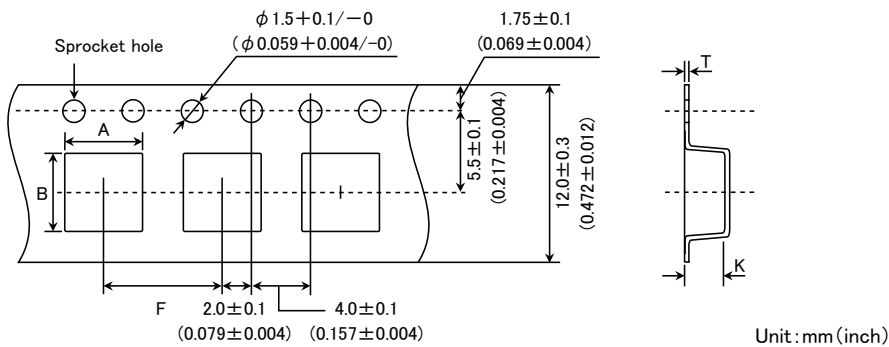

Type	Insertion pitch	Chip cavity		Tape thickness	
		A	B	K	T
BU05MC	$8.0 \pm 0.1$ ( $0.315 \pm 0.004$ )	$5.2 \pm 0.1$ ( $0.205 \pm 0.004$ )	$5.6 \pm 0.1$ ( $0.220 \pm 0.004$ )	$3.2 \pm 0.1$ ( $0.126 \pm 0.004$ )	$0.4 \pm 0.05$ ( $0.016 \pm 0.002$ )

Unit: mm (inch)

### ④ Leader and Blank portion

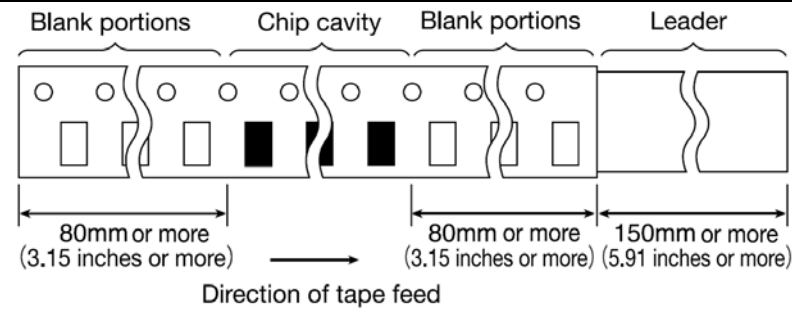

▶ This catalog contains the typical specification only due to the limitation of space. When you consider the purchase of our products, please check our specification. For details of each product (characteristics graph, reliability information, precautions for use, and so on), see our Web site (<http://www.ty-top.com/>).

⑤ Reel size

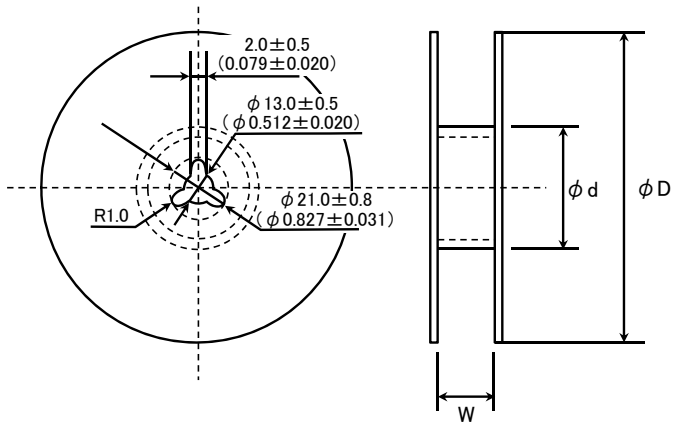

Type	$\phi D$	$\phi d$	W
BU05MC	330±2.0 (12.99±0.079)	80±1.0 (3.15±0.039)	13.5±1.0 (0.53±0.039)

Unit : mm (inch)

# SMD COMMON MODE CHOKE COILS FOR DC AND SIGNAL LINES, BALUN TRANSFORMERS

## PRECAUTIONS

### 1. Circuit Design

Precautions	<ul style="list-style-type: none"> <li>◆Operating environment               <ol style="list-style-type: none"> <li>1. The products described in this specification are intended for use in general electronic equipment, (office supply equipment, telecommunications systems, measuring equipment, and household equipment). They are not intended for use in mission-critical equipment or systems requiring special quality and high reliability (traffic systems, safety equipment, aerospace systems, nuclear control systems and medical equipment including life-support systems,) where product failure might result in loss of life, injury or damage. For such uses, contact TAIYO YUDEN Sales Department in advance.</li> </ol> </li> </ul>
-------------	--

### 2. PCB Design

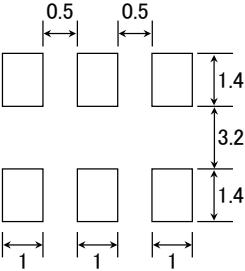
Precautions	<ul style="list-style-type: none"> <li>◆Land pattern design               <ol style="list-style-type: none"> <li>1. Please contact any of our offices for a land pattern, and refer to a recommended land pattern of specifications.</li> </ol> </li> </ul>
Technical considerations	<ul style="list-style-type: none"> <li>◆Land pattern design               <p>Surface Mounting</p> <ul style="list-style-type: none"> <li>• Mounting and soldering conditions should be checked beforehand.</li> <li>• Applicable soldering process to these products is reflow soldering only.</li> <li>• Recommended Land Patterns</li> </ul> <p>【BU05MC】</p>  <p style="text-align: right;">Unit: mm</p> </li> </ul>

### 3. Considerations for automatic placement

Precautions	<ul style="list-style-type: none"> <li>◆Adjustment of mounting machine               <ol style="list-style-type: none"> <li>1. Excessive impact load should not be imposed on the products when mounting onto the PC boards.</li> <li>2. Mounting and soldering conditions should be checked beforehand.</li> </ol> </li> </ul>
Technical considerations	<ul style="list-style-type: none"> <li>◆Adjustment of mounting machine               <ol style="list-style-type: none"> <li>1. When installing products, care should be taken not to apply distortion stress as it may deform the products.</li> </ol> </li> </ul>

### 4. Soldering

Precautions	<ul style="list-style-type: none"> <li>◆Reflow soldering               <ol style="list-style-type: none"> <li>1. Please contact any of our offices for a reflow soldering, and refer to the recommended condition specified.</li> <li>2. This product can be used reflow soldering only.</li> <li>3. Please do not add any stress to a product until it returns in normal temperature after reflow soldering.</li> </ol> </li> <li>◆Lead free soldering               <ol style="list-style-type: none"> <li>1. When using products with lead free soldering, we request to use them after confirming adhesion, temperature of resistance to soldering heat, soldering etc sufficiently.</li> </ol> </li> <li>◆Recommended conditions for using a soldering iron               <p>【BU05MC】</p> <ul style="list-style-type: none"> <li>• Put the soldering iron on the land-pattern.</li> <li>• Soldering iron's temperature - Below 350°C</li> <li>• Duration - 3 seconds or less</li> <li>• The soldering iron should not directly touch the inductor.</li> </ul> </li> </ul>
Technical considerations	<ul style="list-style-type: none"> <li>◆Reflow soldering               <ol style="list-style-type: none"> <li>1. If products are used beyond the range of the recommended conditions, heat stresses may deform the products, and consequently degrade the reliability of the products.</li> </ol> </li> <li>◆Recommended conditions for using a soldering iron               <p>If products are used beyond the range of the recommended conditions, heat stresses may deform the products, and consequently degrade the reliability of the products.</p> </li> </ul>

### 5. Cleaning

Precautions	<ul style="list-style-type: none"> <li>◆Cleaning conditions               <ol style="list-style-type: none"> <li>1. Please contact any of our offices for a cleaning.</li> </ol> </li> </ul>
-------------	--

▶ This catalog contains the typical specification only due to the limitation of space. When you consider the purchase of our products, please check our specification. For details of each product (characteristics graph, reliability information, precautions for use, and so on), see our Web site (<http://www.ty-top.com/>).

6. Handling	
Precautions	<ul style="list-style-type: none"> <li>◆ Handling               <ol style="list-style-type: none"> <li>1. Keep the product away from all magnets and magnetic objects.</li> </ol> </li> <li>◆ Breakaway PC boards (splitting along perforations)               <ol style="list-style-type: none"> <li>1. When splitting the PC board after mounting product, care should be taken not to give any stresses of deflection or twisting to the board.</li> <li>2. Board separation should not be done manually, but by using the appropriate devices.</li> </ol> </li> <li>◆ Mechanical considerations               <ol style="list-style-type: none"> <li>1. Please do not give the product any excessive mechanical shocks.</li> <li>2. Please do not add any shock and power to a product in transportation.</li> </ol> </li> <li>◆ Pick-up pressure               <ol style="list-style-type: none"> <li>1. Please do not push to add any pressure to a winding part. Please do not give any shock and push onto an exposed part of ferrite cores.</li> </ol> </li> <li>◆ Packing               <ol style="list-style-type: none"> <li>1. Please avoid accumulation of a packing box as much as possible.</li> </ol> </li> </ul>
Technical considerations	<ul style="list-style-type: none"> <li>◆ Handling               <ol style="list-style-type: none"> <li>1. There is a case that a characteristic varies with magnetic influence.</li> </ol> </li> <li>◆ Breakaway PC boards (splitting along perforations)               <ol style="list-style-type: none"> <li>1. The position of the product on PCBs shall be carefully considered to minimize the stress caused from splitting of the PCBs.</li> </ol> </li> <li>◆ Mechanical considerations               <ol style="list-style-type: none"> <li>1. There is a case to be damaged by a mechanical shock.</li> <li>2. There is a case to be broken by the handling in transportation.</li> </ol> </li> <li>◆ Pick-up pressure               <ol style="list-style-type: none"> <li>1. An excessive shock or stress may cause a damage to the product or a deterioration of a characteristic.</li> </ol> </li> <li>◆ Packing               <ol style="list-style-type: none"> <li>1. If packing boxes are accumulated, that could cause a deformation on packing tapes or a damage on the products.</li> </ol> </li> </ul>
7. Storage conditions	
Precautions	<ul style="list-style-type: none"> <li>◆ Storage               <ol style="list-style-type: none"> <li>1. To maintain the solderability of terminal electrodes and to keep the packing material in good condition, temperature and humidity in the storage area should be controlled.                   <ul style="list-style-type: none"> <li>• Recommended conditions                       <p>Ambient temperature : 0~40°C, Humidity : Below 70% RH</p> <p>The ambient temperature must be kept below 30°C. Even under ideal storage conditions, the solderability of electrodes may decrease gradually. For this reason, the products should be used within one year from the time of delivery. In case of storage over 6 months, solderability shall be checked before actual usage.</p> </li> </ul> </li> </ol> </li> </ul>
Technical considerations	<ul style="list-style-type: none"> <li>◆ Storage               <ol style="list-style-type: none"> <li>1. Under a high temperature and humidity environment, problems such as reduced solderability caused by oxidation of terminal electrodes and deterioration of taping/packaging materials may take place.</li> </ol> </li> </ul>

# LEADED COMMON MODE CHOKE COILS FOR DC AND SIGNAL LINES

WAVE

■ PARTS NUMBER

\* Operating Temp.: -25~+105°C (Including self-generated heat)

T	L	F	△	9	U	B	H	3	0	2	W	K	1
①	②	③	④	⑤	⑥								

△=Blank space

① Series name

Code	Series name
TLF	Common mode choke coil

② Dimensions of core

Code	Dimensions of core [mm]
△9	9

③ Shape

Code	Shape
UB△	U core, vertically split wound
UBH	U core, horizontally split wound

④ Nominal inductance

Code (example)	Nominal inductance [μH]
302	3000
203	20000

⑤ Inductance tolerance

Code	Inductance tolerance
W	+100/-10%

⑥ Internal code

Code	Internal code
K1	Adhesive fixation

■ STANDARD EXTERNAL DIMENSIONS / MINIMUM QUANTITY

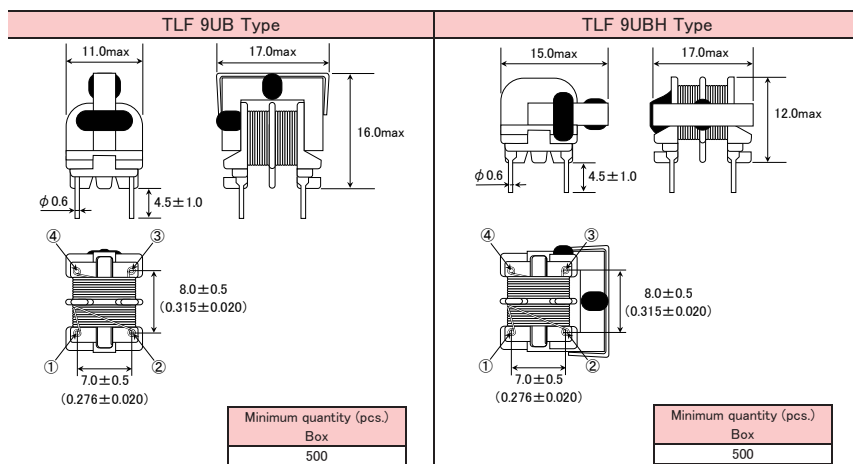

Unit : mm (inch)

■ PARTS NUMBER

Parts number	EHS	Number of lines	Nominal inductance [mH]	Inductance tolerance	DC Resistance [Ω] (max.)	Rated current [A] (max.)	Rated voltage [V] (D.C.)	Insulation resistance [MΩ] (min.)
TLF 9UBH302W K1	RoHS	2	3.0	+100/-10%	1.5	0.40	50	100
TLF 9UB 302W K1	RoHS	2	3.0	+100/-10%	1.5	0.40	50	100
TLF 9UBH802W K1	RoHS	2	8.0	+100/-10%	3.0	0.30	50	100
TLF 9UB 802W K1	RoHS	2	8.0	+100/-10%	3.0	0.30	50	100
TLF 9UBH203W K1	RoHS	2	20.0	+100/-10%	6.5	0.18	50	100
TLF 9UB 203W K1	RoHS	2	20.0	+100/-10%	6.5	0.18	50	100

NOISE SUPPRESSION COMPONENTS

COMMON MODE CHOKE COILS

► This catalog contains the typical specification only due to the limitation of space. When you consider the purchase of our products, please check our product specification sheets. For details of each product (characteristics graph, reliability information, precautions for use, and so on), see our website (<http://www.ty-top.com/>).

# LEADED COMMON MODE CHOKE COILS FOR AC LINES

WAVE

■ PARTS NUMBER

\*Operating Temp. : -25~+105°C (Including self-generated heat)

T	L	F	△	9	U	A	△	1	0	2	W	0	R	8	K	1
①	②	③	④	⑤	⑥	⑦										

△=Blank space

① Series name

Code	Series name
TLF	Common mode choke
TLH	Hybrid choke

② Dimensions of core

Code	Dimensions of core [mm]
△9	9
10	10

③ Shape

Code	Shape
UA△	U core, vertical type
UAH	U core, horizontal type
UB△	U core, vertically split wound

④ Nominal Inductance

Code (example)	Nominal Inductance [μH]
102	1000
103	10000

⑤ Inductance tolerance

Code	Inductance tolerance
△	Nominal Values or higher
W	+100/-10%

⑥ Rated current

Code	Rated current [A]
R54	0.54
0R8	0.8

※R=Decimal point

⑦ Internal code

Code	Internal code
K1	Adhesive fixation

■ STANDARD EXTERNAL DIMENSIONS / MINIMUM QUANTITY

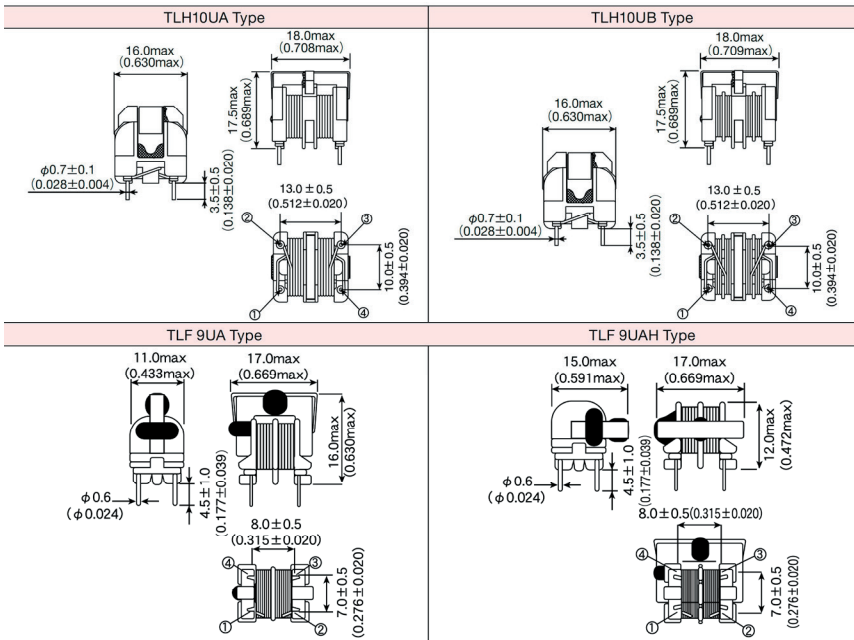

Unit: mm (inch)

Type	Minimum quantity (pcs.)
	Box
TLH type	500
TLF type	

▶ This catalog contains the typical specification only due to the limitation of space. When you consider the purchase of our products, please check our product specification sheets. For details of each product (characteristics graph, reliability information, precautions for use, and so on), see our website (<http://www.ty-top.com/>).

## PARTS NUMBER

## ● TLH10UA type (Hybrid choke)

Parts number	EHS	Common mode inductance [mH]	Inductance tolerance	Normal mode inductance [mH] (typ.)	DC Resistance [ $\Omega$ ] (max.)	Rated current [A] (max.)	Rated voltage AC [V] (max.)
TLH10UA 901 2R0	RoHS	0.9	min.	0.067	0.089	2.0	250
TLH10UA 112 1R8	RoHS	1.1	min.	0.087	0.126	1.8	250
TLH10UA 152 1R6	RoHS	1.5	min.	0.126	0.171	1.6	250
TLH10UA 212 1R4	RoHS	2.1	min.	0.160	0.222	1.4	250
TLH10UA 282 1R2	RoHS	2.8	min.	0.215	0.272	1.2	250
TLH10UA 432 1R0	RoHS	4.3	min.	0.330	0.398	1.0	250
TLH10UA 622 0R8	RoHS	6.2	min.	0.430	0.578	0.8	250
TLH10UA 872 0R7	RoHS	8.7	min.	0.644	0.878	0.7	250
TLH10UA 992 0R6	RoHS	9.9	min.	0.836	1.138	0.6	250
TLH10UA 143 0R5	RoHS	14	min.	1.256	1.567	0.5	250

## ● TLH10UB type (Hybrid choke)

Parts number	EHS	Common mode inductance [mH]	Inductance tolerance	Normal mode inductance [mH] (typ.)	DC Resistance [ $\Omega$ ] (max.)	Rated current [A] (max.)	Rated voltage AC [V] (max.)
TLH10UB 701 2R0	RoHS	0.7	min.	0.056	0.097	2.0	250
TLH10UB 112 1R7	RoHS	1.1	min.	0.068	0.133	1.7	250
TLH10UB 142 1R4	RoHS	1.4	min.	0.113	0.214	1.4	250
TLH10UB 232 1R2	RoHS	2.3	min.	0.150	0.274	1.2	250
TLH10UB 352 1R0	RoHS	3.5	min.	0.232	0.422	1.0	250
TLH10UB 442 0R8	RoHS	4.4	min.	0.328	0.624	0.8	250
TLH10UB 872 0R7	RoHS	8.7	min.	0.580	0.982	0.7	250
TLH10UB 972 0R6	RoHS	9.7	min.	0.735	1.314	0.6	250
TLH10UB 113 0R5	RoHS	11	min.	0.877	1.577	0.5	250

## ● TLF 9UA type

Parts number	EHS	Common mode inductance [mH]	Inductance tolerance	DC Resistance [ $\Omega$ ] (max.)	Rated current [A] (max.)	Rated voltage AC [V] (max.)
TLF 9UA 102W0R8K1	RoHS	1.0	+100/-10%	0.5	0.80	250
TLF 9UA 202WR54K1	RoHS	2.0	+100/-10%	1.0	0.54	250
TLF 9UA 302WR42K1	RoHS	3.0	+100/-10%	1.5	0.42	250
TLF 9UA 502WR32K1	RoHS	5.0	+100/-10%	2.5	0.32	250
TLF 9UA 802WR25K1	RoHS	8.0	+100/-10%	4.0	0.25	250
TLF 9UA 103WR23K1	RoHS	10	+100/-10%	4.5	0.23	250

## ● TLF 9UAH type

Parts number	EHS	Common mode inductance [mH]	Inductance tolerance	DC Resistance [ $\Omega$ ] (max.)	Rated current [A] (max.)	Rated voltage AC [V] (max.)
TLF 9UAH102W0R8K1	RoHS	1.0	+100/-10%	0.5	0.80	250
TLF 9UAH202WR54K1	RoHS	2.0	+100/-10%	1.0	0.54	250
TLF 9UAH302WR42K1	RoHS	3.0	+100/-10%	1.5	0.42	250
TLF 9UAH502WR32K1	RoHS	5.0	+100/-10%	2.5	0.32	250
TLF 9UAH802WR25K1	RoHS	8.0	+100/-10%	4.0	0.25	250
TLF 9UAH103WR23K1	RoHS	10	+100/-10%	4.5	0.23	250

# LEADED COMMON MODE CHOKE COILS FOR DC AND SIGNAL LINES

## LEADED COMMON MODE CHOKE COILS FOR AC LINES

---

### ■ PACKAGING

---

#### ① Minimum Quantity

---

##### ● TLH/TLF Type

Type	Minimum Quantity [pcs]
	Box
TLH10UA	1000
TLH10UB	
TLF9UA□	500
TLF9UB□	

---

# LEADED COMMON MODE CHOKE COILS FOR DC AND SIGNAL LINES, LEADED COMMON MODE CHOKE COILS FOR AC LINES

## RELIABILITY DATA

1. Operating Temperature Range										
Specified Value	TLH, TLF Type	-25 ~ + 105°C								
Test Method and Remarks	Including temperature rise due to self-generated heat.									
2. Storage temperature range										
Specified Value	TLH, TLF Type	-40 ~ + 85°C								
3. Rated current										
Specified Value	TLH, TLF Type	Within the specified range								
Test Method and Remarks	TLH10U : The maximum value of AC current within the temperature rise of 60°C TLF9UA : The maximum value of AC current within the temperature rise of 45°C TLF9UB : The maximum value of DC current within the temperature rise of 45°C									
4. Inductance										
Specified Value	TLH, TLF Type	Within the specified tolerance								
Test Method and Remarks	TLF9U : Measuring equipment : LCR meter 4284A or its equivalent Measuring frequency : 1kHz Measuring voltage : 1Vrms TLH, TLF (except TLF9U) : Measuring equipment : LCR meter 4284A or its equivalent Measuring frequency : 1kHz Measuring voltage : 0.1Vrms									
5. DC resistance										
Specified Value	TLH, TLF Type	Within the specified tolerance								
Test Method and Remarks	Measuring equipment : DC ohmmeter									
6. Terminal strength tensile force										
Specified Value	TLH, TLF Type	No abnormality								
Test Method and Remarks	TLH10UA, TLH10UB, TLF9U : Apply the stated tensile force gradually in the direction to draw terminal. <table border="1" style="margin-left: 20px;"> <thead> <tr> <th>force [N]</th> <th>duration [s]</th> </tr> </thead> <tbody> <tr> <td>5</td> <td>30±5</td> </tr> </tbody> </table> TLF (except TLF9U): Apply the stated tensile force gradually in the direction to draw terminal. <table border="1" style="margin-left: 20px;"> <thead> <tr> <th>force [N]</th> <th>duration [s]</th> </tr> </thead> <tbody> <tr> <td>10</td> <td>30±5</td> </tr> </tbody> </table>		force [N]	duration [s]	5	30±5	force [N]	duration [s]	10	30±5
force [N]	duration [s]									
5	30±5									
force [N]	duration [s]									
10	30±5									
7. Insulation resistance between wires										
Specified Value	TLH, TLF Type	100M Ω min.								
Test Method and Remarks	Applied voltage : 500VDC (TLH, TLF (except TLF9UB)) : 250VDC (TLF9UB) Duration : 60sec.									

▶ This catalog contains the typical specification only due to the limitation of space. When you consider the purchase of our products, please check our specification. For details of each product (characteristics graph, reliability information, precautions for use, and so on), see our Web site (<http://www.ty-top.com/>).

8. Insulation resistance between wire and core		
Specified Value	TLH, TLF Type	100M $\Omega$ min. (except TLH)
Test Method and Remarks	TLF : Applied voltage : 500VDC (TLF (except TLF9UB)) : 250VDC (TLF9UB) Duration : 60 sec.	
9. Withstanding : between wires		
Specified Value	TLH, TLF Type	No abnormality
Test Method and Remarks	Applied voltage : 2000VAC (TLH, TLF (except TLF9UB)) : 500VDC (TLF9UB) Duration : 60sec	
10. Withstanding : between wires and core		
Specified Value	TLH, TLF Type	No abnormality (except TLH)
Test Method and Remarks	TLF : Applied voltage : 2000VAC (TLF (except TLF9UB)) : 500VDC (TLF9UB) Duration : 60sec.	
11. Rated voltage		
Specified Value	TLH, TLF Type	Within the specified range
Test Method and Remarks	TLH, TLF (except TLF9UB) : 250VAC TLF9UB : 50VDC	
12. Resistance to vibration		
Specified Value	TLH, TLF Type	TLF9U : Inductance change : Within $\pm 5\%$ TLH, TLF (except TLF9U) : Appearance is no abnormality and within the specified range
Test Method and Remarks	TLH, TLF : According to JIS C60068-2-6. Direction : 2hrs each in X, Y and Z direction Total : 6hrs Frequency range : 10 to 55 to 10Hz (1 min.) Amplitude : 1.5mm (shall not exceed acceleration 196m/s <sup>2</sup> ) Mounting method : soldering onto PC board Recovery : At least 1hr of recovery under the standard condition after the removal from test chamber, followed by the measurement within 2hrs.	
13. Solderability		
Specified Value	TLH, TLF Type	At least 90% of terminal electrode is covered by new solder.
Test Method and Remarks	TLH, TLF : Solder temperature : 235 $\pm$ 0.5 $^{\circ}$ C Duration : 2 $\pm$ 0.5sec. Immersion depth : Up to 1.5 to 2.0mm from PBC mounted level.  TLH, TLF : Solder temperature : 245 $\pm$ 5 $^{\circ}$ C Duration : 4 $\pm$ 1sec. Immersion depth : Up to 1.0 to 1.5mm from PBC mounted level.	

▶ This catalog contains the typical specification only due to the limitation of space. When you consider the purchase of our products, please check our specification. For details of each product (characteristics graph, reliability information, precautions for use, and so on), see our Web site (<http://www.ty-top.com/>).

14. Resistance to soldering heat		
Specified Value	TLH, TLF Type	TLF9UA : Inductance change : Within $\pm 5\%$
Test Method and Remarks	TLH, TLF : Solder temperature : $260 \pm 5^\circ\text{C}$ Duration : $5 \pm 0.5\text{sec.}$ Immersion depth : Up to 1.5 to 2.0mm from PBC mounted level. Recovery : At least 1hr of recovery under the standard condition after the removal from test chamber, followed by the measurement within 2hrs.  TLH, TLF : Solder temperature : $260 \pm 5^\circ\text{C}$ Duration : $10 \pm 1\text{sec.}$ Immersion depth : Up to 1.0 to 1.5mm from PBC mounted level. Recovery : At least 1hr of recovery under the standard condition after the removal from test chamber, followed by the measurement within 2hrs.	

15. Thermal shock		
Specified Value	TLH, TLF Type	TLF9UA : Inductance change : Within $\pm 15\%$ TLH, TLF (except TLF9UA) : Withstanding voltage : No abnormality Insulation resistance : No abnormality
Test Method and Remarks	TLH, TLF : According to JIS C60068-2-14. Conditions for 1 cycle $-25^\circ\text{C} \sim +85^\circ\text{C}$ , keep each 30min  Number of cycles : 10 Recovery : At least 1hr of recovery under the standard condition after the removal from test chamber, followed by the measurement within 2 hrs.	

16. Damp heat		
Specified Value	TLH, TLF Type	TLF9UA : Inductance change : Within $\pm 15\%$ TLH, TLF (except TLF9UA) : Withstanding voltage : No abnormality Insulation resistance : No abnormality
Test Method and Remarks	TLH, TLF : Temperature : $60 \pm 2^\circ\text{C}$ : $40 \pm 2^\circ\text{C}$ (※except TLF9U) Humidity : $90 \sim 95\%RH$ Duration : 500 hrs Recovery : At least 1hr of recovery under the standard removal from test chamber followed by the measurement within 2 hrs.	

17. Loading under damp heat						
Specified Value	TLH, TLF Type	Withstanding voltage : No abnormality Insulation resistance : No abnormality				
Test Method and Remarks	TLH, TLF : Temperature : $60 \pm 2^\circ\text{C}$ : $40 \pm 2^\circ\text{C}$ (※except TLF9U ) Humidity : $90 \sim 95\%RH$ Duration : 100 hrs : 500 hrs Apply rated current across windings (※except TLF9U ) Applied voltage : Apply the following specified voltage between windings. <table border="1" style="margin-left: 40px;"> <tr> <td>TLF9UA</td> <td>250VAC</td> </tr> <tr> <td>TLF9UB</td> <td>50VDC</td> </tr> </table> Recovery : At least 1hr of recovery under the standard removal from test chamber followed by the measurement within 2 hrs.		TLF9UA	250VAC	TLF9UB	50VDC
TLF9UA	250VAC					
TLF9UB	50VDC					

▶ This catalog contains the typical specification only due to the limitation of space. When you consider the purchase of our products, please check our specification. For details of each product (characteristics graph, reliability information, precautions for use, and so on), see our Web site (<http://www.ty-top.com/>).

18. Low temperature life test		
Specified Value	TLH, TLF Type	TLF9U : Inductance change : Within $\pm 15\%$ TLH, TLF (except TLF9U) : Withstanding voltage : No abnormality Insulation resistance : No abnormality
Test Method and Remarks	TLH, TLF : Temperature : $-25 \pm 2^\circ\text{C}$ : $-40 \pm 2^\circ\text{C}$ (※TLF•TLH) Duration : 500 hrs Recovery : At least 1hr of recovery under the standard removal from test chamber followed by the measurement within 2 hrs.	

19. High Temperature life test		
Specified Value	TLH, TLF Type	TLF9U : Inductance change : Within $\pm 15\%$ TLH, TLF (except TLF9U) : Withstanding voltage : No abnormality Insulation resistance : No abnormality
Test Method and Remarks	TLH, TLF : Temperature : $105 \pm 3^\circ\text{C}$ (※ TLF•TLH) Duration : 500 hrs Recovery : At least 1hr of recovery under the standard removal from test chamber followed by the measurement within 2 hrs.	

# LEADED COMMON MODE CHOKE COILS FOR DC AND SIGNAL LINES, LEADED COMMON MODE CHOKE COILS FOR AC LINES

## ■ PRECAUTIONS

1. Circuit Design	
Precautions	<ul style="list-style-type: none"> <li>◆Operating environment               <ol style="list-style-type: none"> <li>1. The products described in this specification are intended for use in general electronic equipment, (office supply equipment, telecommunications systems, measuring equipment, and household equipment). They are not intended for use in mission-critical equipment or systems requiring special quality and high reliability (traffic systems, safety equipment, aerospace systems, nuclear control systems and medical equipment including life-support systems) where product failure might result in loss of life, injury or damage. For such uses, contact TAIYO YUDEN Sales Department in advance.</li> </ol> </li> </ul>
2. PCB Design	
Precautions	<ul style="list-style-type: none"> <li>◆Design               <ol style="list-style-type: none"> <li>1. Please design insertion pitches as matching to that of leads of the component on PCBs.</li> </ol> </li> </ul>
Technical considerations	<ul style="list-style-type: none"> <li>◆Design               <ol style="list-style-type: none"> <li>1. When Inductors are mounted onto a PC board, hole dimensions on the board should match the lead pitch of the component, if not, it will cause breakage of the terminals or cracking of terminal roots covered with resin as excess stress travels through the terminal legs.</li> </ol> </li> </ul>
3. Soldering	
Precautions	<ul style="list-style-type: none"> <li>◆Wave soldering               <ol style="list-style-type: none"> <li>1. Please refer to the specifications in the catalog for a wave soldering.</li> <li>2. Do not immerse the entire inductor in the flux during the soldering operation.</li> </ol> </li> <li>◆Lead free soldering               <ol style="list-style-type: none"> <li>1. When using products with lead free soldering, we request to use them after confirming of adhesion, temperature of resistance to soldering heat, etc. sufficiently.</li> </ol> </li> <li>◆Recommended conditions for using a soldering iron               <ul style="list-style-type: none"> <li>• Put the soldering iron on the land-pattern.</li> <li>• Soldering iron's temperature – Below 350°C</li> <li>• Duration – 3 seconds or less</li> <li>• The soldering iron should not directly touch the product.</li> </ul> </li> </ul>
Technical considerations	<ul style="list-style-type: none"> <li>◆Lead free soldering               <ol style="list-style-type: none"> <li>1. If products are used beyond the range of the recommended conditions, heat stresses may deform the products, and consequently degrade the reliability of the products.</li> </ol> </li> <li>◆Recommended conditions for using a soldering iron               <p>If products are used beyond the range of the recommended conditions, heat stresses may deform the products, and consequently degrade the reliability of the products.</p> </li> </ul>
4. Cleaning	
Precautions	<ul style="list-style-type: none"> <li>◆Cleaning conditions               <ol style="list-style-type: none"> <li>1. Please contact any of our offices for about a cleaning.</li> </ol> </li> </ul>
5. Handling	
Precautions	<ul style="list-style-type: none"> <li>◆Handling               <ol style="list-style-type: none"> <li>1. Keep the product away from all magnets and magnetic objects.</li> </ol> </li> <li>◆Mechanical considerations               <ol style="list-style-type: none"> <li>1. Please do not give the product any excessive mechanical shocks.</li> <li>2. Please do not add any shock or power to a product in transportation.</li> </ol> </li> <li>◆Packing               <ol style="list-style-type: none"> <li>1. Please do not give the product any excessive mechanical shocks. In loading, please pay attention to handling indication mentioned in a packing box (a loading direction / number of maximum loading / fragile item).</li> </ol> </li> </ul>
Technical considerations	<ul style="list-style-type: none"> <li>◆Handling               <ol style="list-style-type: none"> <li>1. There is a case that a characteristic varies with magnetic influence.</li> </ol> </li> <li>◆Mechanical considerations               <ol style="list-style-type: none"> <li>1. There is a case to be damaged by a mechanical shock.</li> <li>2. There is a case to be broken by a fall.</li> </ol> </li> <li>◆Packing               <ol style="list-style-type: none"> <li>1. There is a case that a lead route turns at by a fall or an excessive shock.</li> </ol> </li> </ul>

▶ This catalog contains the typical specification only due to the limitation of space. When you consider the purchase of our products, please check our specification. For details of each product (characteristics graph, reliability information, precautions for use, and so on), see our Web site (<http://www.ty-top.com/>).

## 6. Storage conditions

Precautions	<p>◆Storage</p> <p>1. To maintain the solderability of terminal electrodes and to keep the packing material in good condition, temperature and humidity in the storage area should be controlled.</p> <ul style="list-style-type: none"><li>• Recommended conditions</li></ul> <p>Ambient temperature : 0~40°C Humidity : Below 70% RH</p> <p>The ambient temperature must be kept below 30°C. Even under ideal storage conditions, the solderability of electrodes decreases gradually, so the products should be mounted within one year from the time of delivery.</p> <p>In case of storage over 6 months, solderability shall be checked before actual usage.</p>
Technical considerations	<p>◆Storage</p> <p>1. Under a high temperature and humidity environment, problems such as reduced solderability caused by oxidation of terminal electrodes and deterioration of taping/packaging materials may take place.</p>





## Looking for pricing, stock, or lifecycle information?

Click below to explore more details on WIN SOURCE:

 [View MCF12102H500-T on WIN SOURCE](#)

 [Taiyo Yuden Information](#)

## Optimize Your Supply Chain with WIN SOURCE Solutions

-  Global Sourcing Solution
-  Obsolete Management
-  Cost Control Management
-  Shortage Management
-  Alternative Solution
-  Excess Inventory Management