



**THE DATASHEET OF  
CD74HC08QM96Q1**



# CD74HC08-Q1 QUADRUPLE 2-INPUT POSITIVE-AND GATE

SCLS512A – JULY 2003 – REVISED FEBRUARY 2008

- Qualified for Automotive Applications
- ESD Protection Exceeds 2000 V Per MIL-STD-883, Method 3015; Exceeds 200 V Using Machine Model (C = 200 pF, R = 0)
- Buffered Inputs
- Typical Propagation Delay 7 ns at  $V_{CC} = 5\text{ V}$ ,  $C_L = 15\text{ pF}$ ,  $T_A = 25^\circ\text{C}$
- Fanout (Over Temperature Range)
  - Standard Outputs . . . 10 LSTTL Loads
  - Bus Driver Outputs . . . 15 LSTTL Loads
- Extended Temperature Performance of  $-40^\circ\text{C}$  to  $125^\circ\text{C}$
- Balanced Propagation Delay and Transition Times
- Significant Power Reduction, Compared to LSTTL Logic ICs
- 2-V to 6-V  $V_{CC}$  Operation
- High Noise Immunity  $N_{IL}$  or  $N_{IH} = 30\%$  of  $V_{CC}$  at  $V_{CC} = 5\text{ V}$
- CMOS Input Compatibility,  $I_I \leq 1\ \mu\text{A}$  at  $V_{OL}$ ,  $V_{OH}$

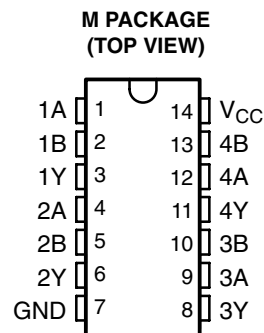

## description/ordering information

The CD74HC08 logic gates utilize silicon-gate CMOS technology to achieve operating speeds similar to LSTTL gates, with the low power consumption of standard CMOS integrated circuits. The device can drive 10 LSTTL loads.

## ORDERING INFORMATION†

$T_A$	PACKAGE‡		ORDERABLE PART NUMBER	TOP-SIDE MARKING
$-40^\circ\text{C}$ to $125^\circ\text{C}$	SOIC – M	Tape and reel	CD74HC08QM96Q1	HC08Q

† For the most current package and ordering information, see the Package Option Addendum at the end of this document, or see the TI web site at <http://www.ti.com>.

‡ Package drawings, thermal data, and symbolization are available at <http://www.ti.com/packaging>.

## FUNCTION TABLE (each gate)

INPUTS		OUTPUT
A	B	Y
H	H	H
L	X	L
X	L	L

## logic diagram (positive logic)

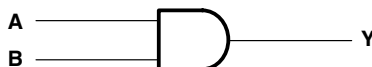

Please be aware that an important notice concerning availability, standard warranty, and use in critical applications of Texas Instruments semiconductor products and disclaimers thereto appears at the end of this data sheet.

PRODUCTION DATA information is current as of publication date. Products conform to specifications per the terms of Texas Instruments standard warranty. Production processing does not necessarily include testing of all parameters.

 **TEXAS  
INSTRUMENTS**

POST OFFICE BOX 655303 • DALLAS, TEXAS 75265

Copyright © 2008, Texas Instruments Incorporated

# CD74HC08-Q1

## QUADRUPLE 2-INPUT POSITIVE-AND GATE

SCLS512A – JULY 2003 – REVISED FEBRUARY 2008

### absolute maximum ratings over operating free-air temperature range (unless otherwise noted)<sup>†</sup>

Supply voltage range, $V_{CC}$	-0.5 V to 7 V
Input clamp current, $I_{IK}$ ( $V_I < -0.5$ V or $V_I > V_{CC} + 0.5$ V) (see Note 1)	±20 mA
Output clamp current, $I_{OK}$ ( $V_O < -0.5$ V or $V_O > V_{CC} + 0.5$ V) (see Note 1)	±20 mA
Continuous output current, $I_O$ ( $V_O > -0.5$ or $V_O < V_{CC} + 0.5$ V)	±25 mA
Continuous current through $V_{CC}$ or GND	±50 mA
Package thermal impedance, $\theta_{JA}$ (see Note 2)	180°C/W
Maximum junction temperature, $T_J$	150°C
Lead temperature (during soldering):	
At distance $1/16 \pm 1/32$ inch ( $1.59 \pm 0.79$ mm) from case for 10 s max	300°C
Storage temperature range, $T_{stg}$	-65°C to 150°C

<sup>†</sup> Stresses beyond those listed under “absolute maximum ratings” may cause permanent damage to the device. These are stress ratings only, and functional operation of the device at these or any other conditions beyond those indicated under “recommended operating conditions” is not implied. Exposure to absolute-maximum-rated conditions for extended periods may affect device reliability.

- NOTES: 1. The input and output voltage ratings may be exceeded if the input and output current ratings are observed.  
 2. The package thermal impedance is calculated in accordance with JESD 51-7.

### recommended operating conditions (see Note 3)

		MIN	NOM	MAX	UNIT
$V_{CC}$	Supply voltage	2	5	6	V
$V_{IH}$	High-level input voltage	$V_{CC} = 2$ V	1.5		V
		$V_{CC} = 4.5$ V	3.15		
		$V_{CC} = 6$ V	4.2		
$V_{IL}$	Low-level input voltage	$V_{CC} = 2$ V		0.5	V
		$V_{CC} = 4.5$ V		1.35	
		$V_{CC} = 6$ V		1.8	
$V_I$	Input voltage	0		$V_{CC}$	V
$V_O$	Output voltage	0		$V_{CC}$	V
$\Delta t/\Delta v$	Input transition rise/fall time	$V_{CC} = 2$ V		1000	ns
		$V_{CC} = 4.5$ V		500	
		$V_{CC} = 6$ V		400	
$T_A$	Operating free-air temperature	-40		125	°C

NOTE 3: All unused inputs of the device must be held at  $V_{CC}$  or GND to ensure proper device operation. Refer to the TI application report, *Implications of Slow or Floating CMOS Inputs*, literature number SCBA004.



# CD74HC08-Q1 QUADRUPLE 2-INPUT POSITIVE-AND GATE

SCLS512A – JULY 2003 – REVISED FEBRUARY 2008

**electrical characteristics over recommended operating free-air temperature range (unless otherwise noted)**

PARAMETER	TEST CONDITIONS		I <sub>O</sub> (mA)	V <sub>CC</sub>	T <sub>A</sub> = 25°C			CD74HC08-Q1		UNIT
					MIN	TYP	MAX	MIN	MAX	
V <sub>OH</sub>	V <sub>I</sub> = V <sub>IH</sub> or V <sub>IL</sub>	CMOS loads	-0.02	2 V	1.9			1.9	V	
			-0.02	4.5 V	4.4			4.4		
			-0.02	6 V	5.9			5.9		
		TTL loads	-4	4.5 V	3.98			3.7		
			-5.2	6 V	5.48			5.2		
V <sub>OL</sub>	V <sub>I</sub> = V <sub>IH</sub> or V <sub>IL</sub>	CMOS loads	0.02	2 V			0.1	0.1	V	
			0.02	4.5 V			0.1	0.1		
			0.02	6 V			0.1	0.1		
		TTL loads	4	4.5 V			0.26	0.4		
			5.2	6 V			0.26	0.4		
I <sub>I</sub>	V <sub>I</sub> = V <sub>CC</sub> or GND			6 V			±0.1	±1	μA	
I <sub>CC</sub>	V <sub>I</sub> = V <sub>CC</sub> or GND		0	6 V			2	40	μA	
C <sub>i</sub>							10	10	pF	

**switching characteristics over recommended operating free-air temperature range (unless otherwise noted) (see Figure 1)**

PARAMETER	FROM (INPUT)	TO (OUTPUT)	CONDITIONS	V <sub>CC</sub>	T <sub>A</sub> = 25°C			CD74HC08-Q1		UNIT
					MIN	TYP	MAX	MIN	MAX	
t <sub>pd</sub>	A or B	Y	C <sub>L</sub> = 50 pF	2 V			90	135	ns	
				4.5 V			18	27		
				6 V			15	23		
				5 V		7				
t <sub>t</sub>		Y	C <sub>L</sub> = 50 pF	2 V			75	110	ns	
				4.5 V			15	22		
				6 V			13	19		

**operating characteristics, T<sub>A</sub> = 25°C, V<sub>CC</sub> = 5V**

PARAMETER	TEST CONDITIONS	TYP	UNIT
C <sub>pd</sub> Power dissipation capacitance per gate (see Note 4)	No load	37	pF

NOTE 4: C<sub>pd</sub> is used to determine the dynamic power consumption, per gate.

$$P_D = V_{CC}^2 f_I (C_{pd} + C_L)$$

f<sub>I</sub> = input frequency

C<sub>L</sub> = output load capacitance

V<sub>CC</sub> = supply voltage

# CD74HC08-Q1 QUADRUPLE 2-INPUT POSITIVE-AND GATE

SCLS512A – JULY 2003 – REVISED FEBRUARY 2008

## PARAMETER MEASUREMENT INFORMATION

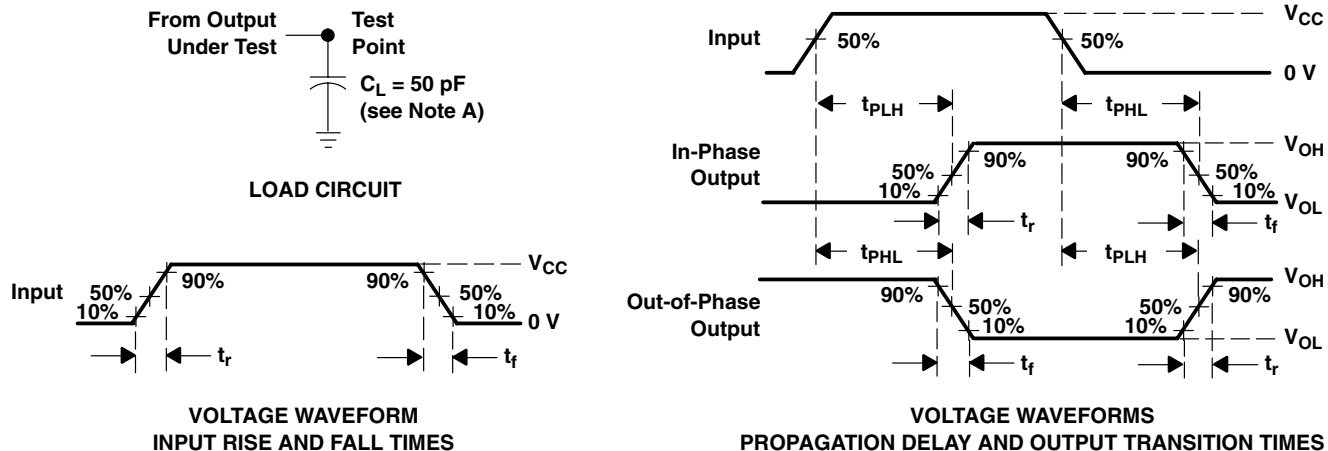

- NOTES:
- A.  $C_L$  includes probe and test-fixture capacitance.
  - B. Phase relationships between waveforms were chosen arbitrarily. All input pulses are supplied by generators having the following characteristics:  $PRR \leq 1$  MHz,  $Z_O = 50 \Omega$ ,  $t_r = 6$  ns,  $t_f = 6$  ns.
  - C. The outputs are measured one at a time with one input transition per measurement.
  - D.  $t_{PLH}$  and  $t_{PHL}$  are the same as  $t_{pd}$ .

Figure 1. Load Circuit and Voltage Waveforms

**PACKAGING INFORMATION**

Orderable Device	Status (1)	Package Type	Package Drawing	Pins	Package Qty	Eco Plan (2)	Lead/Ball Finish (6)	MSL Peak Temp (3)	Op Temp (°C)	Device Marking (4/5)	Samples
CD74HC08QM96Q1	ACTIVE	SOIC	D	14	2500	Green (RoHS & no Sb/Br)	CU NIPDAU	Level-1-260C-UNLIM	-40 to 125	HC08Q1	Samples

(1) The marketing status values are defined as follows:

**ACTIVE:** Product device recommended for new designs.

**LIFEBUY:** TI has announced that the device will be discontinued, and a lifetime-buy period is in effect.

**NRND:** Not recommended for new designs. Device is in production to support existing customers, but TI does not recommend using this part in a new design.

**PREVIEW:** Device has been announced but is not in production. Samples may or may not be available.

**OBSOLETE:** TI has discontinued the production of the device.

(2) Eco Plan - The planned eco-friendly classification: Pb-Free (RoHS), Pb-Free (RoHS Exempt), or Green (RoHS & no Sb/Br) - please check <http://www.ti.com/productcontent> for the latest availability information and additional product content details.

**TBD:** The Pb-Free/Green conversion plan has not been defined.

**Pb-Free (RoHS):** TI's terms "Lead-Free" or "Pb-Free" mean semiconductor products that are compatible with the current RoHS requirements for all 6 substances, including the requirement that lead not exceed 0.1% by weight in homogeneous materials. Where designed to be soldered at high temperatures, TI Pb-Free products are suitable for use in specified lead-free processes.

**Pb-Free (RoHS Exempt):** This component has a RoHS exemption for either 1) lead-based flip-chip solder bumps used between the die and package, or 2) lead-based die adhesive used between the die and leadframe. The component is otherwise considered Pb-Free (RoHS compatible) as defined above.

**Green (RoHS & no Sb/Br):** TI defines "Green" to mean Pb-Free (RoHS compatible), and free of Bromine (Br) and Antimony (Sb) based flame retardants (Br or Sb do not exceed 0.1% by weight in homogeneous material)

(3) MSL, Peak Temp. - The Moisture Sensitivity Level rating according to the JEDEC industry standard classifications, and peak solder temperature.

(4) There may be additional marking, which relates to the logo, the lot trace code information, or the environmental category on the device.

(5) Multiple Device Markings will be inside parentheses. Only one Device Marking contained in parentheses and separated by a "~" will appear on a device. If a line is indented then it is a continuation of the previous line and the two combined represent the entire Device Marking for that device.

(6) Lead/Ball Finish - Orderable Devices may have multiple material finish options. Finish options are separated by a vertical ruled line. Lead/Ball Finish values may wrap to two lines if the finish value exceeds the maximum column width.

**Important Information and Disclaimer:** The information provided on this page represents TI's knowledge and belief as of the date that it is provided. TI bases its knowledge and belief on information provided by third parties, and makes no representation or warranty as to the accuracy of such information. Efforts are underway to better integrate information from third parties. TI has taken and continues to take reasonable steps to provide representative and accurate information but may not have conducted destructive testing or chemical analysis on incoming materials and chemicals. TI and TI suppliers consider certain information to be proprietary, and thus CAS numbers and other limited information may not be available for release.

In no event shall TI's liability arising out of such information exceed the total purchase price of the TI part(s) at issue in this document sold by TI to Customer on an annual basis.

**OTHER QUALIFIED VERSIONS OF CD74HC08-Q1 :**

- Catalog: [CD74HC08](#)
- Enhanced Product: [CD74HC08-EP](#)
- Military: [CD54HC08](#)



## NOTE: Qualified Version Definitions:

- Catalog - TI's standard catalog product
- Enhanced Product - Supports Defense, Aerospace and Medical Applications
- Military - QML certified for Military and Defense Applications

D (R-PDSO-G14)

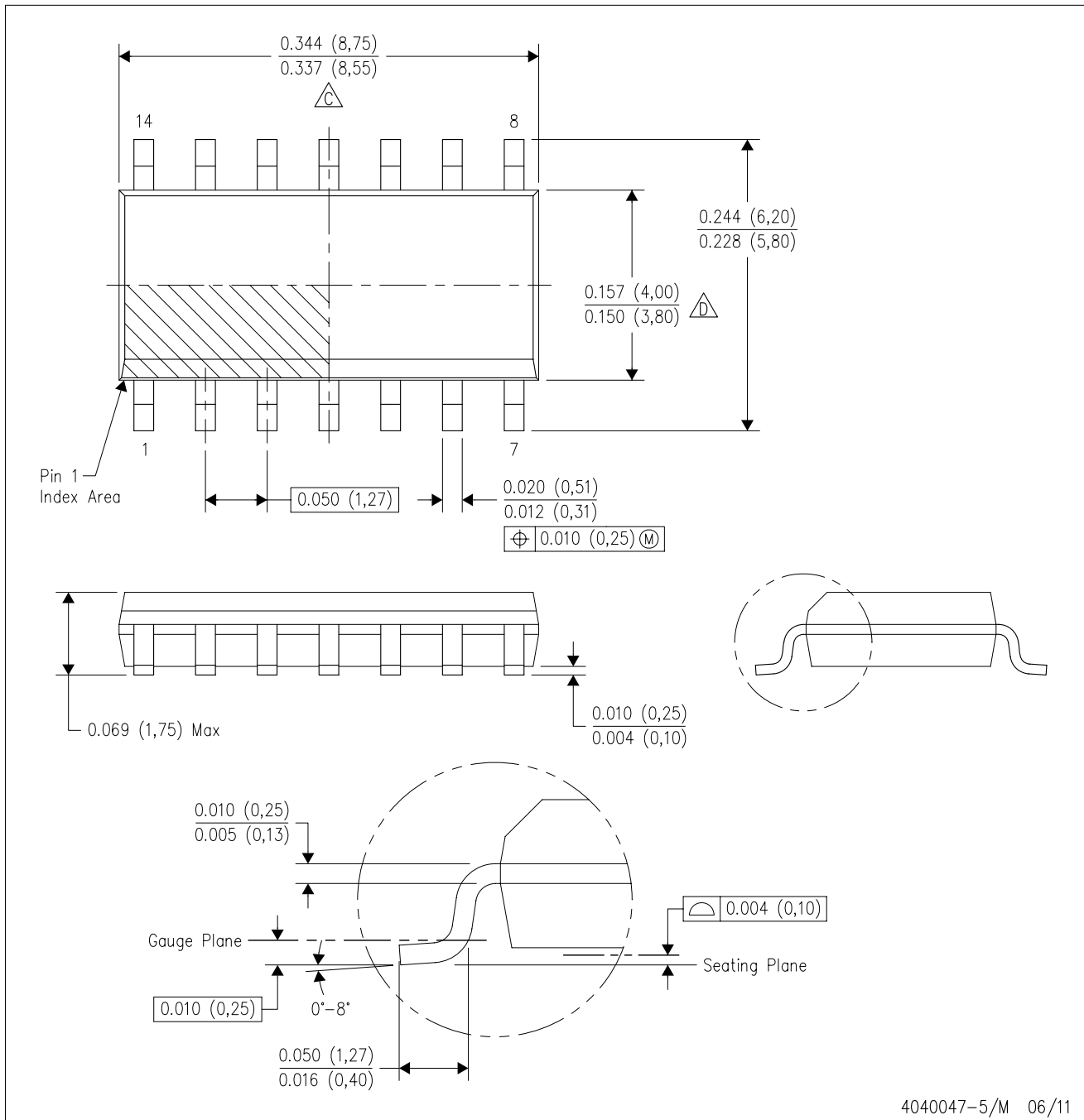
PLASTIC SMALL OUTLINE



- NOTES:
- A. All linear dimensions are in inches (millimeters).
  - B. This drawing is subject to change without notice.
  -  Body length does not include mold flash, protrusions, or gate burrs. Mold flash, protrusions, or gate burrs shall not exceed 0.006 (0,15) each side.
  -  Body width does not include interlead flash. Interlead flash shall not exceed 0.017 (0,43) each side.
  - E. Reference JEDEC MS-012 variation AB.

D (R-PDSO-G14)

PLASTIC SMALL OUTLINE

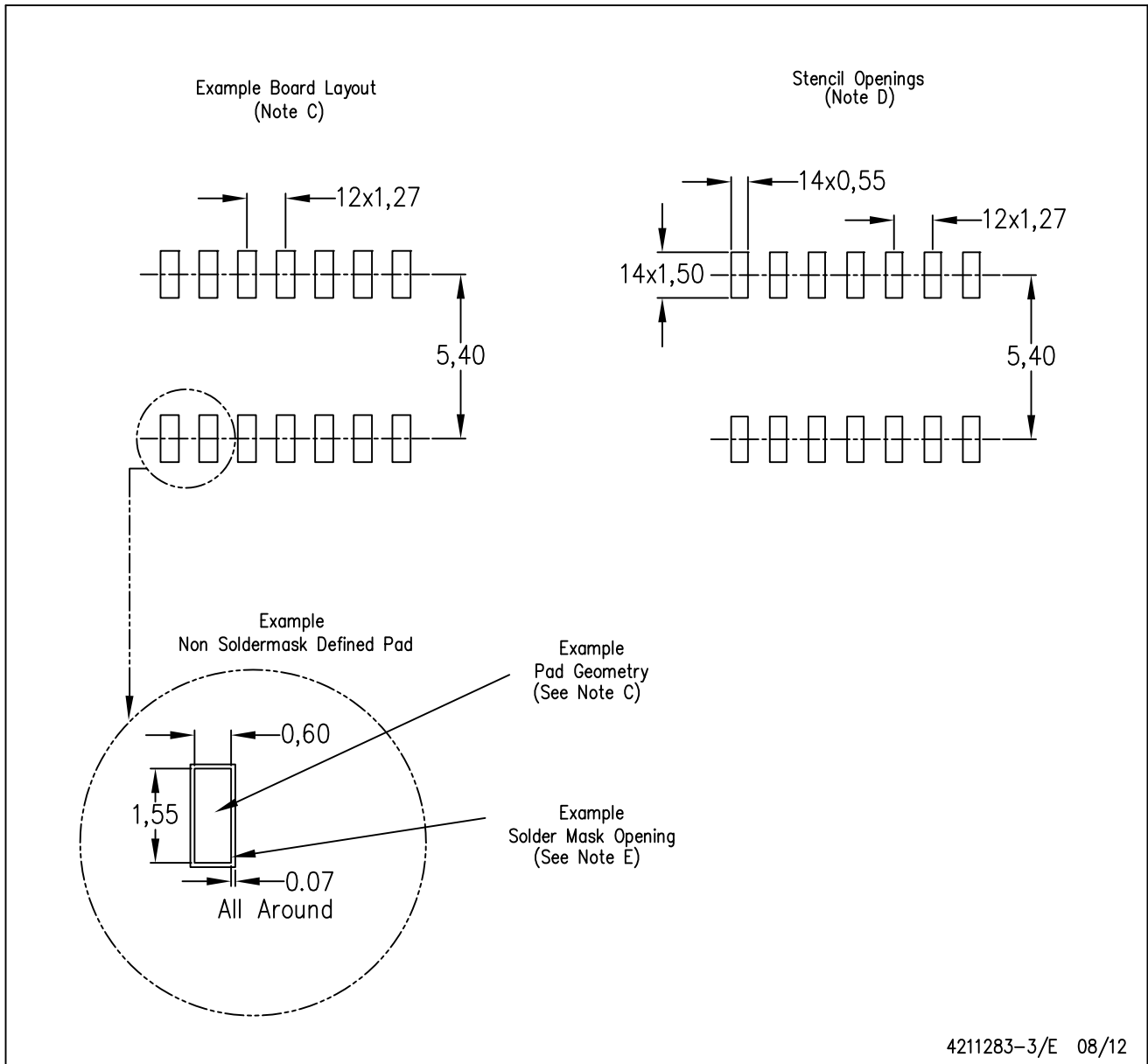

- NOTES:
- A. All linear dimensions are in millimeters.
  - B. This drawing is subject to change without notice.
  - C. Publication IPC-7351 is recommended for alternate designs.
  - D. Laser cutting apertures with trapezoidal walls and also rounding corners will offer better paste release. Customers should contact their board assembly site for stencil design recommendations. Refer to IPC-7525 for other stencil recommendations.
  - E. Customers should contact their board fabrication site for solder mask tolerances between and around signal pads.

## IMPORTANT NOTICE

Texas Instruments Incorporated and its subsidiaries (TI) reserve the right to make corrections, enhancements, improvements and other changes to its semiconductor products and services per JESD46, latest issue, and to discontinue any product or service per JESD48, latest issue. Buyers should obtain the latest relevant information before placing orders and should verify that such information is current and complete. All semiconductor products (also referred to herein as "components") are sold subject to TI's terms and conditions of sale supplied at the time of order acknowledgment.

TI warrants performance of its components to the specifications applicable at the time of sale, in accordance with the warranty in TI's terms and conditions of sale of semiconductor products. Testing and other quality control techniques are used to the extent TI deems necessary to support this warranty. Except where mandated by applicable law, testing of all parameters of each component is not necessarily performed.

TI assumes no liability for applications assistance or the design of Buyers' products. Buyers are responsible for their products and applications using TI components. To minimize the risks associated with Buyers' products and applications, Buyers should provide adequate design and operating safeguards.

TI does not warrant or represent that any license, either express or implied, is granted under any patent right, copyright, mask work right, or other intellectual property right relating to any combination, machine, or process in which TI components or services are used. Information published by TI regarding third-party products or services does not constitute a license to use such products or services or a warranty or endorsement thereof. Use of such information may require a license from a third party under the patents or other intellectual property of the third party, or a license from TI under the patents or other intellectual property of TI.

Reproduction of significant portions of TI information in TI data books or data sheets is permissible only if reproduction is without alteration and is accompanied by all associated warranties, conditions, limitations, and notices. TI is not responsible or liable for such altered documentation. Information of third parties may be subject to additional restrictions.

Resale of TI components or services with statements different from or beyond the parameters stated by TI for that component or service voids all express and any implied warranties for the associated TI component or service and is an unfair and deceptive business practice. TI is not responsible or liable for any such statements.

Buyer acknowledges and agrees that it is solely responsible for compliance with all legal, regulatory and safety-related requirements concerning its products, and any use of TI components in its applications, notwithstanding any applications-related information or support that may be provided by TI. Buyer represents and agrees that it has all the necessary expertise to create and implement safeguards which anticipate dangerous consequences of failures, monitor failures and their consequences, lessen the likelihood of failures that might cause harm and take appropriate remedial actions. Buyer will fully indemnify TI and its representatives against any damages arising out of the use of any TI components in safety-critical applications.

In some cases, TI components may be promoted specifically to facilitate safety-related applications. With such components, TI's goal is to help enable customers to design and create their own end-product solutions that meet applicable functional safety standards and requirements. Nonetheless, such components are subject to these terms.

No TI components are authorized for use in FDA Class III (or similar life-critical medical equipment) unless authorized officers of the parties have executed a special agreement specifically governing such use.

Only those TI components which TI has specifically designated as military grade or "enhanced plastic" are designed and intended for use in military/aerospace applications or environments. Buyer acknowledges and agrees that any military or aerospace use of TI components which have **not** been so designated is solely at the Buyer's risk, and that Buyer is solely responsible for compliance with all legal and regulatory requirements in connection with such use.

TI has specifically designated certain components as meeting ISO/TS16949 requirements, mainly for automotive use. In any case of use of non-designated products, TI will not be responsible for any failure to meet ISO/TS16949.

### Products

Audio	<a href="http://www.ti.com/audio">www.ti.com/audio</a>
Amplifiers	<a href="http://amplifier.ti.com">amplifier.ti.com</a>
Data Converters	<a href="http://dataconverter.ti.com">dataconverter.ti.com</a>
DLP® Products	<a href="http://www.dlp.com">www.dlp.com</a>
DSP	<a href="http://dsp.ti.com">dsp.ti.com</a>
Clocks and Timers	<a href="http://www.ti.com/clocks">www.ti.com/clocks</a>
Interface	<a href="http://interface.ti.com">interface.ti.com</a>
Logic	<a href="http://logic.ti.com">logic.ti.com</a>
Power Mgmt	<a href="http://power.ti.com">power.ti.com</a>
Microcontrollers	<a href="http://microcontroller.ti.com">microcontroller.ti.com</a>
RFID	<a href="http://www.ti-rfid.com">www.ti-rfid.com</a>
OMAP Applications Processors	<a href="http://www.ti.com/omap">www.ti.com/omap</a>
Wireless Connectivity	<a href="http://www.ti.com/wirelessconnectivity">www.ti.com/wirelessconnectivity</a>

### Applications

Automotive and Transportation	<a href="http://www.ti.com/automotive">www.ti.com/automotive</a>
Communications and Telecom	<a href="http://www.ti.com/communications">www.ti.com/communications</a>
Computers and Peripherals	<a href="http://www.ti.com/computers">www.ti.com/computers</a>
Consumer Electronics	<a href="http://www.ti.com/consumer-apps">www.ti.com/consumer-apps</a>
Energy and Lighting	<a href="http://www.ti.com/energy">www.ti.com/energy</a>
Industrial	<a href="http://www.ti.com/industrial">www.ti.com/industrial</a>
Medical	<a href="http://www.ti.com/medical">www.ti.com/medical</a>
Security	<a href="http://www.ti.com/security">www.ti.com/security</a>
Space, Avionics and Defense	<a href="http://www.ti.com/space-avionics-defense">www.ti.com/space-avionics-defense</a>
Video and Imaging	<a href="http://www.ti.com/video">www.ti.com/video</a>

### TI E2E Community

[e2e.ti.com](http://e2e.ti.com)

## Looking for pricing, stock, or lifecycle information?

Click below to explore more details on WIN SOURCE:

 [View CD74HC08QM96Q1 on WIN SOURCE](#)

 [Texas Instruments](#) Information

## Optimize Your Supply Chain with WIN SOURCE Solutions

-  Global Sourcing Solution
-  Obsolete Management
-  Cost Control Management
-  Shortage Management
-  Alternative Solution
-  Excess Inventory Management