



**THE DATASHEET OF  
RPMB5.0-3.0-CT**





**Specifications** (@ Ta= 25°C, nom. Vin= 24VDC, full load, with input cap <sup>(9)</sup>, after warm-up unless otherwise stated)

Parameter	Condition		Min.	Typ.	Max.
Quiescent Current	nom. Vin= 24VDC	3.3Vout		30µA	
		5.0Vout		36µA	
		12Vout		70µA	
		15Vout		140µA	
Internal Power Dissipation	nom. Vin= 24VDC	3.3Vout		1.9W	
		5.0Vout		2W	
		12Vout		2.7W	
		15Vout		2.9W	
Output Voltage Trimming	refer to "OUTPUT VOLTAGE TRIMMING"	3.3, 5.0Vout	1VDC		9VDC
		12, 15Vout	9VDC		24VDC
Minimum Load			0%		
Start-up Time	power up using CTRL function			4.8ms	
				3.8ms	
Rise-time				900µs	
ON/OFF CTRL	DC-DC ON		Open or $1.26VDC < V_{CTRL} < V_{in}$		
	DC-DC OFF		Short to GND or $-0.3VDC < V_{CTRL} < -0.3VDC$		
Input Current of CTRL Pin	DC-DC OFF			25µA	
Standby Current	DC-DC OFF			35µA	
Internal Operating Frequency	for all types			1.4MHz	
Output Ripple and Noise <sup>(9)</sup>	20MHz BW	3.3Vout		20mVp-p	50mVp-p
		5.0Vout		25mVp-p	60mVp-p
		12Vout		40mVp-p	90mVp-p
		15Vout		50mVp-p	100mVp-p

**Notes:**

Note4: Below minimum input voltage range, the module enters 98% duty cycle mode. Output voltage will not meet the output accuracy specification

Note5: Measurements are made with a 22µF MLCC across output (low ESR)

**Efficiency vs. Load**

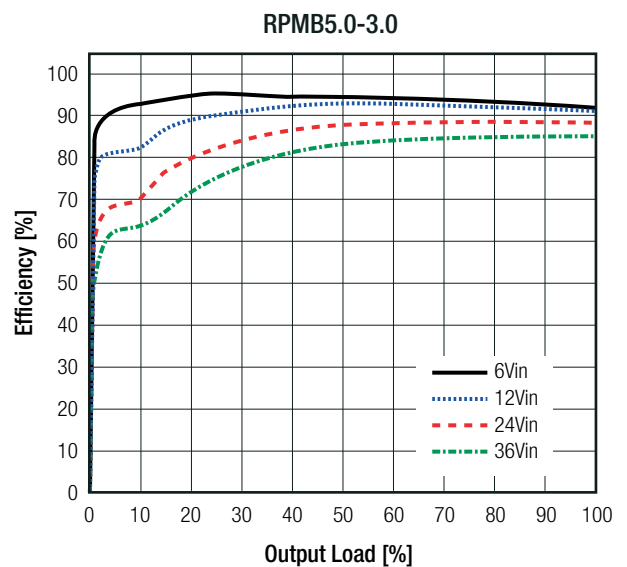
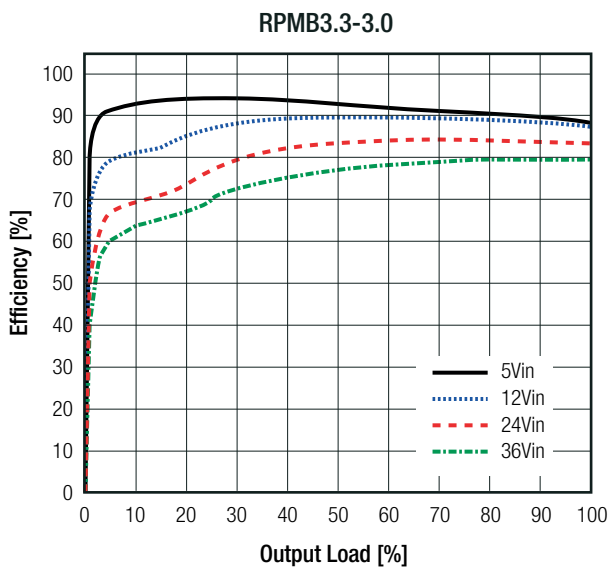

continued on next page

Specifications (@ Ta= 25°C, nom. Vin= 24VDC, full load, with input cap<sup>(9)</sup>, after warm-up unless otherwise stated)

Efficiency vs. Load

RPMB12-3.0

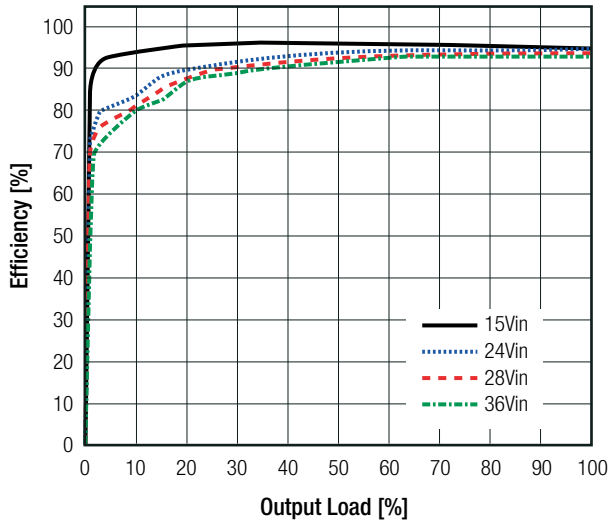

RPMB15-3.0

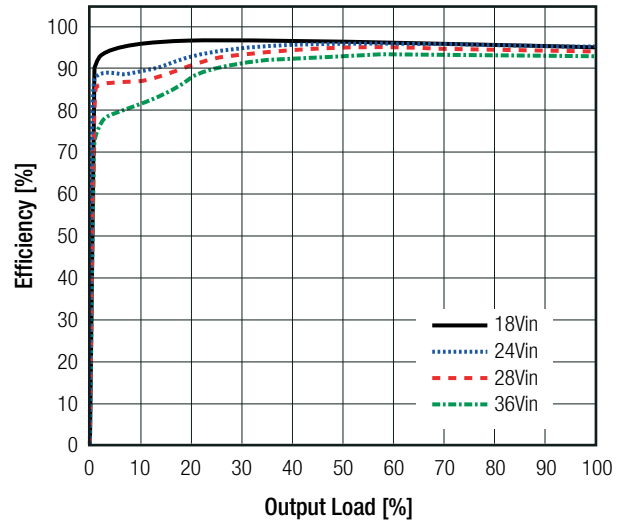

### REMOTE SENSE

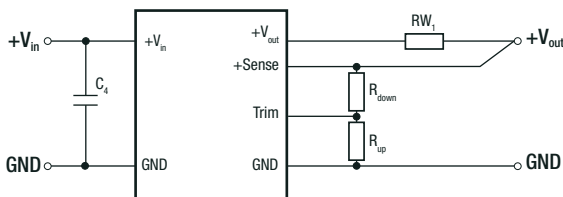

$RW_1$  ... wire losses +  
 $R_{up}$  ... trim up resistor  
 $R_{down}$  ... trim down resistor

The output voltage can be adjusted via trim and sense functions. The maximum output voltage from trim and sense functions combined is 9V and 24V (based on models). Power or thermal derating may be required when using trim and/or sense functions.

### POSITIVE TO NEGATIVE

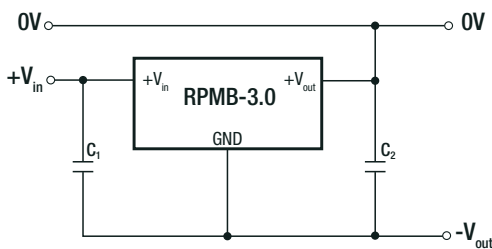

$C_1$  and  $C_2$  may be added to reduced ripple and should be fitted close to the converter pins.

**Notes:**

Note6: RECOM Power Modules can also be used to convert a positive voltage into a negative voltage. Parameters such as maximum Vin, efficiency and maximum operating temperature are reduced. Please contact RECOM for further details.

### OUTPUT VOLTAGE TRIMMING

The RPMB-series offers the feature of trimming the output voltage by using external trim resistors. The values for trim resistors shown in trim tables below are according to standard E96 values; therefore, the specified voltage may slightly vary. Refer to "Selection Guide" for applicable Vout Adjust Range.

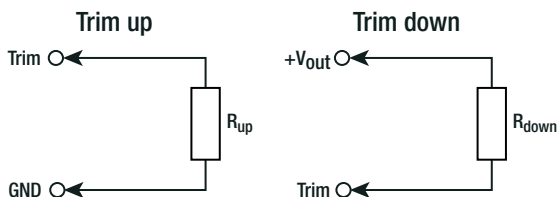

$V_{out_{nom}}$  = nominal output voltage [VDC]  
 $V_{out_{set}}$  = trimmed output voltage [VDC]  
 $R_{up}$  = trim up resistor [ $\Omega$ ]  
 $R_{down}$  = trim down resistor [ $\Omega$ ]  
 $R_3, R_4$  = internal resistors [ $\Omega$ ]

$V_{out_{nom}}$	$R_3$	$R_4$
3.3VDC	100k $\Omega$	43.2k $\Omega$
5VDC	100k $\Omega$	24.9k $\Omega$
12VDC	100k $\Omega$	9.09k $\Omega$
15VDC	90.9k $\Omega$	6.49k $\Omega$

**Calculation:**

$$R_{up} = \frac{R_4 \times (V_{out_{set}} - 1) - R_3 \times (R_4 + 1)}{R_3 - R_4 \times (V_{out_{set}} - 1)}$$

$$R_{down} = \frac{R_4 \times (V_{out_{set}} - 1) \times (R_3 + 1) - R_3}{R_3 - R_4 \times (V_{out_{set}} - 1)}$$

continued on next page

**Specifications** (@ Ta= 25°C, nom. Vin= 24VDC, full load, with input cap <sup>(9)</sup>, after warm-up unless otherwise stated)

**Practical Example RPMB12-3.0**

V<sub>outset</sub> = 15VDC

$$R_{up} = \frac{9.09 \times (15 - 1) - 100 \times (9.09 + 1)}{100 - 9.09 \times (15 - 1)}$$

R<sub>up</sub> according to E96 ≈ **32k4Ω**

**RPMB3.3-3.0**

**Trim up**

V <sub>outset</sub> =	5	[VDC]
R <sub>up</sub> (E96) ≈	57k6	[Ω]

**Trim down**

V <sub>outset</sub> =	2.5	1.8	1.5	1.2	1.1	[VDC]
R <sub>down</sub> (E96) ≈	182k	52k3	26k7	8k45	3k48	[Ω]

**RPMB5.0-3.0**

**Trim up**

V <sub>outset</sub> =	5.5	9	[VDC]
R <sub>up</sub> (E96) ≈	205k	23k7	[Ω]

**Trim down**

V <sub>outset</sub> =	3.3	2.5	[VDC]
R <sub>down</sub> (E96) ≈	133k	59k	[Ω]

**Practical Example RPMB12-3.0**

V<sub>outset</sub> = 9VDC

$$R_{down} = \frac{9.09 \times (9 - 1) \times (100 + 1) - 100}{100 - 9.09 \times (9 - 1)}$$

R<sub>down</sub> according to E96 ≈ **267kΩ**

**RPMB12-3.0**

**Trim up**

V <sub>outset</sub> =	15	24	[VDC]
R <sub>up</sub> (E96) ≈	32k4	7k32	[Ω]

**Trim down**

V <sub>outset</sub> =	10	9	[VDC]
R <sub>down</sub> (E96) ≈	453k	267k	[Ω]

**RPMB15-3.0**

**Trim up**

V <sub>outset</sub> =	20	24	[VDC]
R <sub>up</sub> (E96) ≈	16k9	9k09	[Ω]

**Trim down**

V <sub>outset</sub> =	12	9.99	[VDC]
R <sub>down</sub> (E96) ≈	332k	162k	[Ω]

**REGULATIONS**

Parameter	Condition	Value
Output Accuracy		±1.0% typ. / ±3.0% max.
Line Regulation	low line to high line, full load	±0.25% typ. / ±0.5% max.
Load Regulation	10% to 100% load	0.05% typ.
Transient Response	25% load step change recovery time	200mV 100µs

**PROTECTIONS**

Parameter	Condition	Value
Short Circuit Protection (SCP)	less than 50mΩ	hiccup mode, automatic recovery
Over Current Protection (OCP)		120% min.
Over Temperature Protection (OTP)	case temperature (measured on tc point)	DC-DC OFF DC-DC ON 105°C min., auto restart after cool down 100°C typ.

**ENVIRONMENTAL**

Parameter	Condition	Value
Operating Temperature Range <sup>(7)</sup>	@ natural convection 0.1m/s with derating (refer to "Derating Graph")	-40°C to +100°C
Maximum Case Temperature	measured on tc point (refer to "Dimension Drawing")	+105°C
Temperature Coefficient		0.02%/K
Thermal Impedance <sup>(7)</sup>	0.1m/s, horizontal (T <sub>case</sub> to T <sub>AMB</sub> )	12K/W
Operating Altitude <sup>(8)</sup>	with derating @ natural convection 0.1m/s	5000m
Operating Humidity	non-condensing	5% - 95% RH

continued on next page

**Specifications** (@ Ta= 25°C, nom. Vin= 24VDC, full load, with input cap<sup>(9)</sup>, after warm-up unless otherwise stated)

Parameter	Condition	Value
Shock	MIL-STD-810G, Method 516.6, Procedure I	40g, 11ms, saw-tooth, 3 shocks ± per axis 3 axis; unit is operating
	MIL-STD-810G, Method 516.6, Procedure IV	drop on 50mm plywood on concrete 26 times from 1 meter
Random Vibration	MIL-STD-810G, Method 514.6, Procedure I, Category 24	Category 24 - Figure 514.6E-1 - power spectral density = 0.04g <sup>2</sup> /Hz at 20Hz –1000Hz; -6dB/octave at 1000Hz – 2000Hz; 60 minutes x 3 axis; unit is operating during tests
MTBF	according to MIL-HDBK-217F, G.B. @ full load	+25°C max. T <sub>AMB</sub> 1761 x 10 <sup>3</sup> hours 984 x 10 <sup>3</sup> hours

**Notes:**

Note7: Tested with a eurocard 160x100mm 70µm copper, 4 layer

Note8: At altitudes above 2000m, derate output power by 5%/1000m

**Derating Graph<sup>(6)</sup>**

(@ chamber and natural convection 0.1m/s, @24Vin)

**RPMB3.3-3.0**

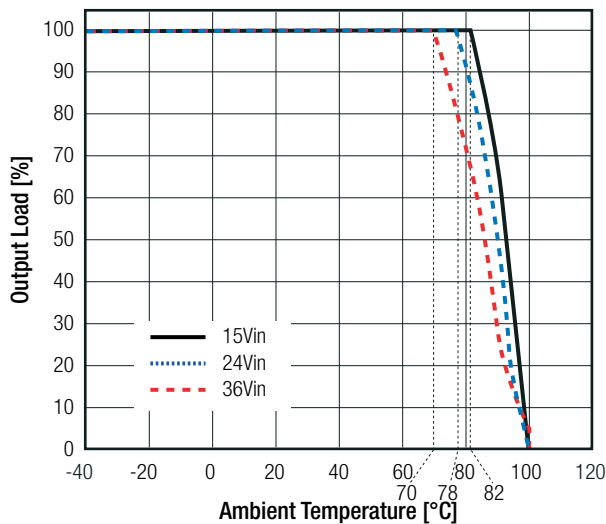

**RPMB5.0-3.0**

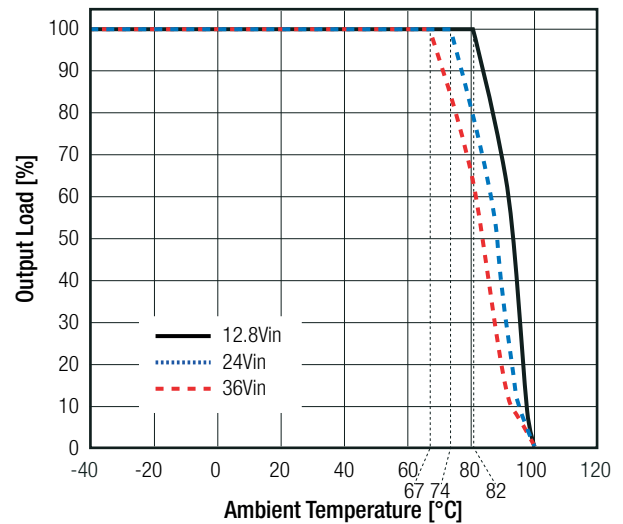

**RPMB12-3.0**

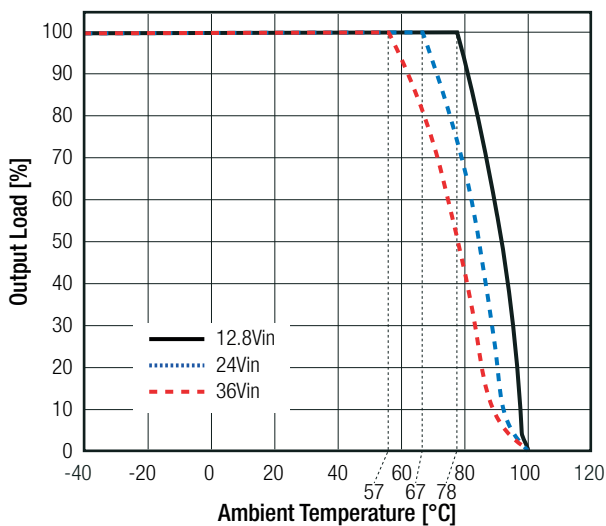

**RPMB15-3.0**

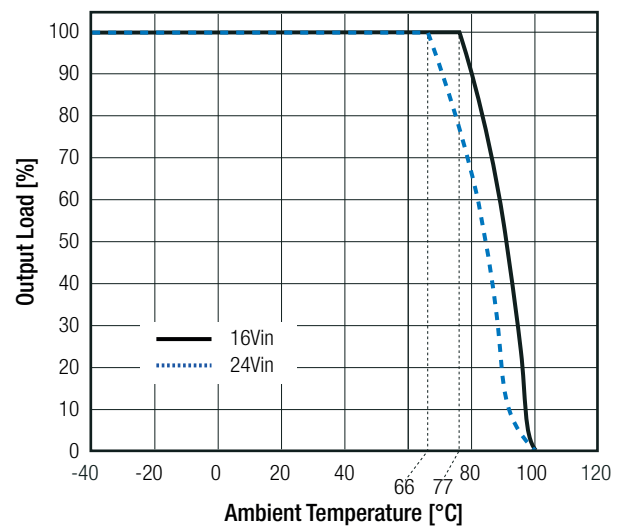

**Specifications** (@ Ta= 25°C, nom. Vin= 24VDC, full load, with input cap <sup>(9)</sup>, after warm-up unless otherwise stated)

### SAFETY AND CERTIFICATIONS

Certificate Type (Safety)	Report / File Number	Standard
RoHS2		RoHS 2011/65/EU + AM2015/863

EMC Compliance	Condition	Standard / Criterion
Electromagnetic compatibility of multimedia equipment - emission requirements <sup>(9)</sup>	with external components (see filter suggestions below)	EN55032, Class B

### EMC filtering suggestion according to EN55032

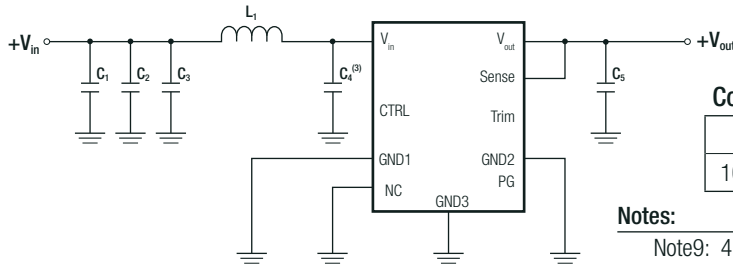

### Component List Class B

C1, C2, C3, C4	L1	C5
10µF 50V X7R, 1210	2.2µH shielded inductor	10µF 25V X7R, 1206

### Notes:

Note9: 4.7µF input capacitor (Note3) is not required if using EMC filter suggestion

### DIMENSION AND PHYSICAL CHARACTERISTICS

Parameter	Type	Value
Material	case PCB solder pads	metal FR4, (UL94 V-0) copper with electrolytic nickel-gold
Dimension (LxWxH)		12.19 x 12.19 x 3.75mm
Weight:		1.1g typ.

### Dimension Drawing (mm)

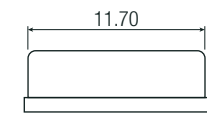
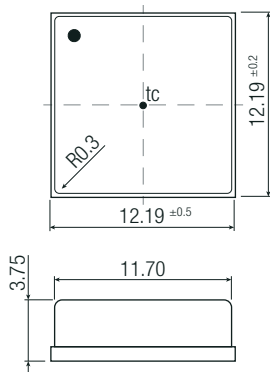
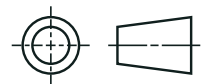

### Bottom View

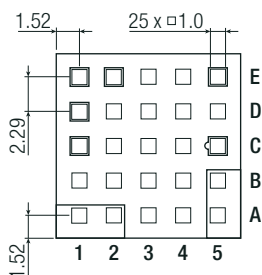

### Recommended Footprint Details Top View

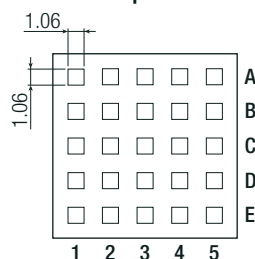

### Pinning information

Pad #	Function	Description
A1, A2	Vin	Positive input voltage with respect to GND. Connect to a Vin plane for enhanced thermal performance
C1	CTRL	Active High: pull to GND to disable the device. Pull high or leave open to enable the device
A5, B5	Vout	Positive output voltage. Connect to a Vout plane for enhanced thermal performance
C5	Sense	Connect this pad to the load or directly to Vout. This pad must not be left floating
E5	Trim	Used to set the output voltage between 1V and 24V, leave open if not used
E2	NC	Not connected, leave open or connect to GND
E1	NC	Not connected, leave open or connect to GND
D1	PGood	Output power good. HIGH = power OK, LOW = power bad. PG pulls low when CTRL = LOW. PG HIGH when VOUT is between 95% and 107% of nominal (VOUT rising) or when between 105% and 93% (VOUT falling) of nominal – typical values. PG delay is typically 110µs (±50%). Maximum sink current is 5mA. Open drain output internally tied to 5V (typical) reference through 100kΩ resistor. Float if not used.
others	GND	Negative input voltage. Connect to GND plane(s) for enhanced thermal performance

tc = case temperature measuring point

Pad tolerance= ±0.05mm

Case tolerance= ±0.25mm

Specifications (@ Ta= 25°C, nom. Vin= 24VDC, full load, with input cap<sup>(3)</sup>, after warm-up unless otherwise stated)

**BLOCKDIAGRAM**

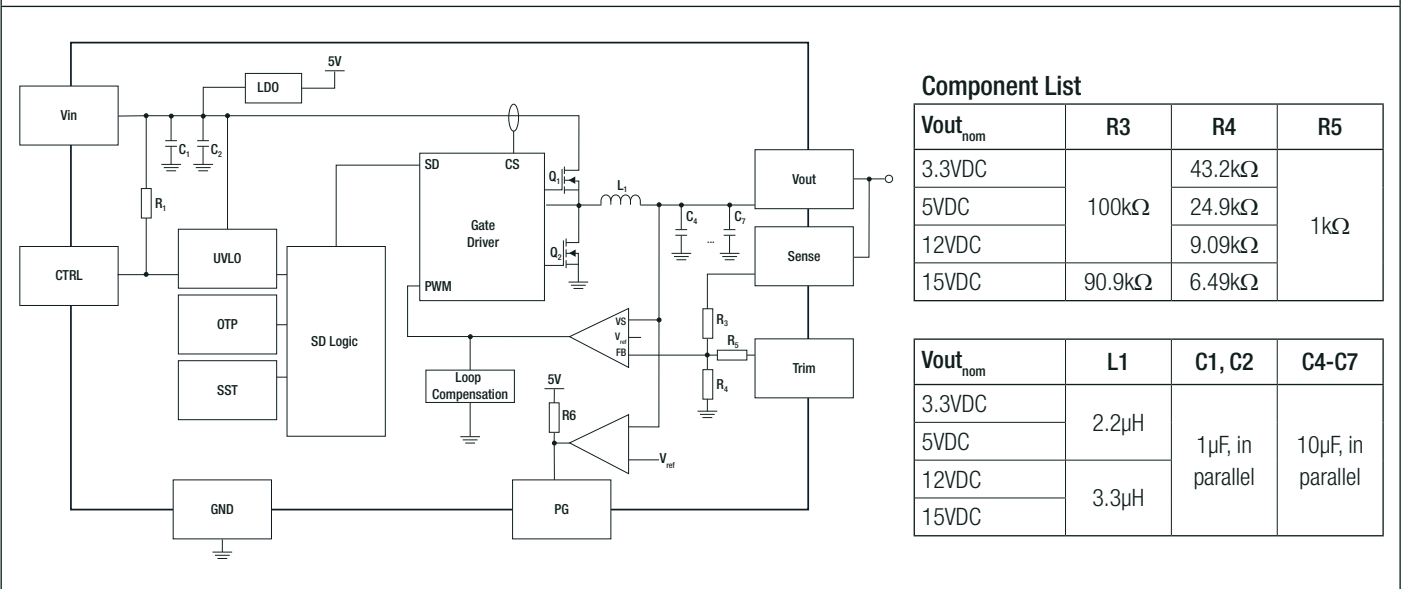

**Component List**

Vout <sub>nom</sub>	R3	R4	R5
3.3VDC	100kΩ	43.2kΩ	1kΩ
5VDC		24.9kΩ	
12VDC		9.09kΩ	
15VDC	90.9kΩ	6.49kΩ	

Vout <sub>nom</sub>	L1	C1, C2	C4-C7
3.3VDC	2.2μH	1μF, in parallel	10μF, in parallel
5VDC			
12VDC	3.3μH		
15VDC			

**PACKAGING INFORMATION**

Parameter	Type	Value
Packaging Dimension (LxWxH)	tape and reel	330.2 x 330.2 x 30.4mm
	tape and reel (carton)	365.0 x 365.0 x 55.0mm
	tube ("CT")	530.0 x 30.3 x 19.2mm
Packaging Quantity	tape and reel	500pcs
	tube ("CT")	30pcs
Tape Width		24mm
Storage Temperature Range		-55°C to +125°C
Storage Humidity	non-condensing	95% RH max.

The product information and specifications may be subject to changes even without prior written notice. The product has been designed for various applications; its suitability lies in the responsibility of each customer. The products are not authorized for use in safety-critical applications without RECOM's explicit written consent. A safety-critical application is an application where a failure may reasonably be expected to endanger or cause loss of life, inflict bodily harm or damage property. The applicant shall indemnify and hold harmless RECOM, its affiliated companies and its representatives against any damage claims in connection with the unauthorized use of RECOM products in such safety-critical applications.

## Looking for pricing, stock, or lifecycle information?

Click below to explore more details on WIN SOURCE:

- ⊖ [View RPMB5.0-3.0-CT on WIN SOURCE](#)
- ⊖ [Recom Power Information](#)

## Optimize Your Supply Chain with WIN SOURCE Solutions

- ✓ Global Sourcing Solution
- ✓ Obsolete Management
- ✓ Cost Control Management
- ✓ Shortage Management
- ✓ Alternative Solution
- ✓ Excess Inventory Management