



THE DATASHEET OF CD4076BE



CMOS 4-Bit D-Type Registers

High-Voltage Types (20-Volt Rating)

■ CD4076B types are four-bit registers consisting of D-type flip-flops that feature three-state outputs. Data Disable inputs are provided to control the entry of data into the flip-flops. When both Data Disable inputs are low, data at the D inputs are loaded into their respective flip-flops on the next positive transition of the clock input. Output Disable inputs are also provided. When the Output Disable inputs are both low, the normal logic states of the four outputs are available to the load. The outputs are disabled independently of the clock by a high logic level at either Output Disable input, and present a high impedance.

The CD4076B types are supplied in 16-lead hermetic dual-in-line ceramic packages (F3A suffix), 16-lead dual-in-line plastic packages (E suffix), 16-lead small-outline packages (M, M96, MT, and NSR suffixes), and 16-lead thin shrink small-outline packages (PW and PWR suffixes).

Features:

- Three-state outputs
- Input disabled without gating the clock
- Gated output control lines for enabling or disabling the outputs
- Standardized, symmetrical output characteristics
- 100% tested for quiescent current at 20 V
- Maximum input current of 1 μ A at 18 V over full package temperature range; 100 nA at 18 V and 25°C
- Noise margin over full package temperature range:
 - 1 V at $V_{DD} = 5$ V
 - 2 V at $V_{DD} = 10$ V
 - 2.5 V at $V_{DD} = 15$ V
- 5-V, 10-V, and 15-V parametric ratings
- Meets all requirements of JEDEC Tentative Standard No. 13B, "Standard Specifications for Description of 'B' Series CMOS Devices"

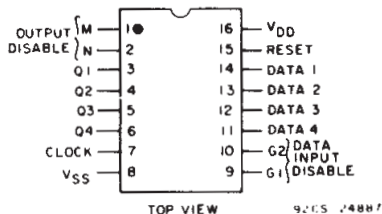

TERMINAL ASSIGNMENT

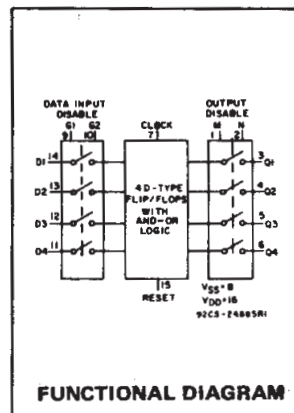

RECOMMENDED OPERATING CONDITIONS at $T_A = 25^\circ\text{C}$, Except as Noted.
For maximum reliability, normal operating conditions should be selected so that operation is always within the following ranges:

| CHARACTERISTIC | V_{DD} (V) | LIMITS | | UNITS |
|---|--------------|--------|------|---------|
| | | Min. | Max. | |
| Supply Voltage Range (For T_A = Full Package Temperature Range) | | 3 | 18 | V |
| Data Setup Time, t_s | 5 | 200 | — | ns |
| | 10 | 80 | — | |
| | 15 | 60 | — | |
| Clock Pulse Width, t_{W} | 5 | 200 | — | ns |
| | 10 | 100 | — | |
| | 15 | 80 | — | |
| Clock Input Frequency, f_{CL} | 5 | — | 3 | MHz |
| | 10 | dc | 6 | |
| | 15 | — | 8 | |
| Clock Input Rise or Fall Time, t_{rCL}, t_{fCL} | 5 | — | 15 | μ s |
| | 10 | — | 5 | |
| | 15 | — | 5 | |
| Reset Pulse Width, t_{W} | 5 | 120 | — | ns |
| | 10 | 50 | — | |
| | 15 | 40 | — | |
| Data Input Disable Setup Time, t_s | 5 | 180 | — | ns |
| | 10 | 100 | — | |
| | 15 | 70 | — | |

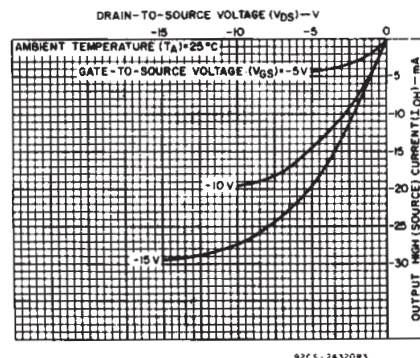
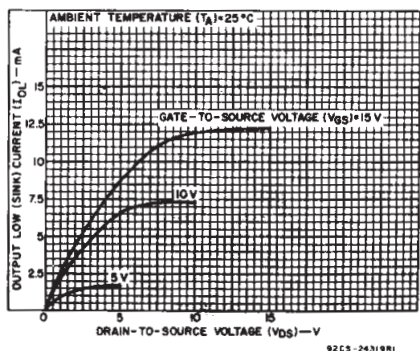
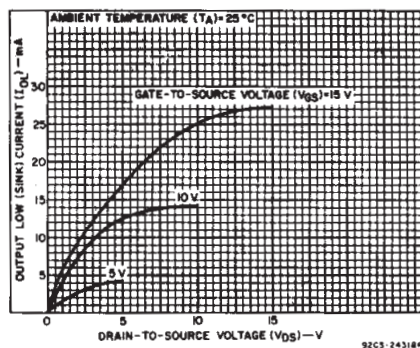

CD4076B Types

MAXIMUM RATINGS, Absolute-Maximum Values:

DC SUPPLY-VOLTAGE RANGE, (V_{DD})

Voltages referenced to V_{SS} Terminal -0.5V to +20V

INPUT VOLTAGE RANGE, ALL INPUTS -0.5V to V_{DD} +0.5V

DC INPUT CURRENT, ANY ONE INPUT ±10mA

POWER DISSIPATION PER PACKAGE (P_D):

For T_A = -55°C to +100°C 500mW

For T_A = +100°C to +125°C Derate Linearly at 12mW/°C to 200mW

DEVICE DISSIPATION PER OUTPUT TRANSISTOR

FOR T_A = FULL PACKAGE-TEMPERATURE RANGE (All Package Types) 100mW

OPERATING-TEMPERATURE RANGE (T_A) -55°C to +125°C

STORAGE TEMPERATURE RANGE (T_{stg}) -65°C to +150°C

LEAD TEMPERATURE (DURING SOLDERING):

At distance 1/16 ± 1/32 inch (1.59 ± 0.79mm) from case for 10s max +265°C

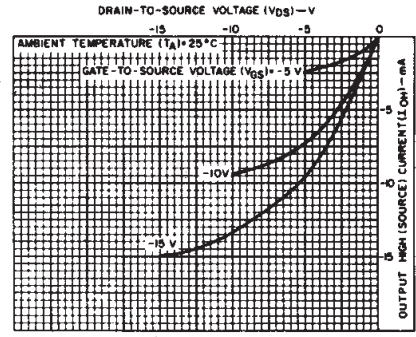
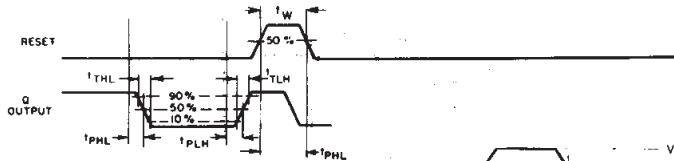
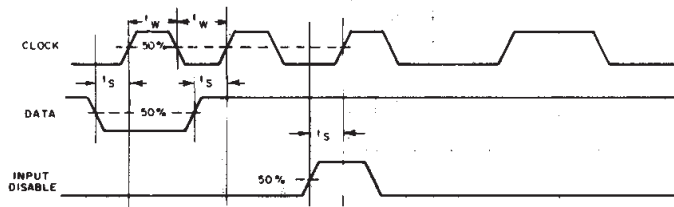
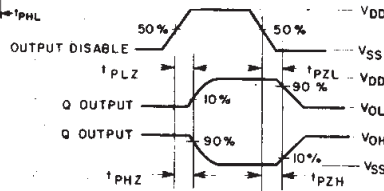

Fig.4 - Minimum output high (source) current characteristics.



92CM-24888R2

(a)



| CHAR. | TEST VOLT. | AT D | AT Q |
|------------------|-----------------|-----------------|------|
| t _{PHZ} | V _{DD} | V _{SS} | |
| t _{PLZ} | V _{SS} | V _{DD} | |
| t _{PZH} | V _{DD} | V _{SS} | |

92CS-29299

(b)

Fig.5 - Functional waveforms for CD4076B.

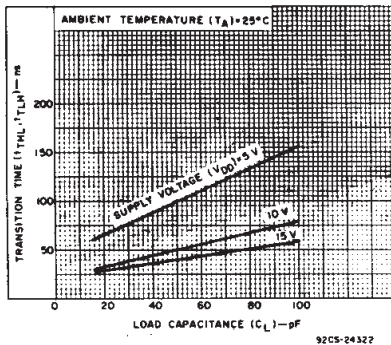

92CS-24322

Fig.7 - Typical transition time vs. load capacitance.

Truth Table

| Reset | Clock | Data Input Disable G1 | Data Input Disable G2 | Data D | Next State Output Q |
|-------|-------|-----------------------|-----------------------|--------|---------------------|
| 1 | X | X | X | X | 0 |
| 0 | 0 | X | X | X | Q |
| 0 | 1 | 1 | X | X | Q |
| 0 | 1 | X | 1 | X | Q |
| 0 | 0 | 0 | 0 | 1 | 1 |
| 0 | 0 | 0 | 0 | 0 | 0 |
| 0 | 1 | X | X | X | Q |
| 0 | 0 | X | X | X | Q |

When either Output Disable M or N is high, the outputs are disabled (high impedance state), however sequential operation of the flip flops is not affected.

1 = High Level
0 = Low Level
X = Don't Care
NC = No Change

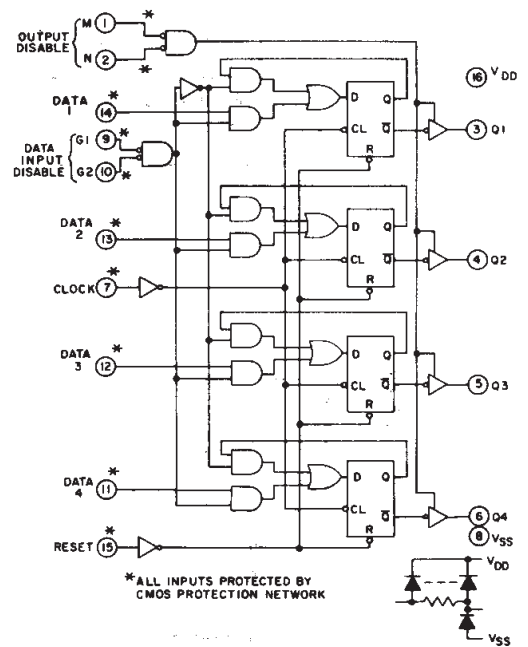

Fig.8 - CD4076B logic diagram.

COMMERCIAL CMOS HIGH VOLTAGE ICs

CD4076B Types

DYNAMIC ELECTRICAL CHARACTERISTICS at $T_A = 25^\circ\text{C}$, Input $t_r, t_f = 20 \text{ ns}$, $C_L = 50 \text{ pF}$, $R_L = 200 \text{ k}\Omega$ (Unless otherwise noted)

| CHARACTERISTIC | TEST CONDITIONS | LIMITS | | | UNITS | |
|---|---------------------------|---------------|------|------|-------|---------------|
| | | V_{DD} V | Min. | Typ. | | Max. |
| Propagation Delay Time: Clock to Q Output, t_{PHL} , t_{PLH} | | 5 | | 300 | 600 | |
| | | 10 | | 125 | 250 | |
| | | 15 | | 90 | 180 | |
| Reset, t_{PHL} | | 5 | | 230 | 460 | ns |
| | | 10 | | 100 | 200 | |
| | | 15 | | 75 | 150 | |
| 3-State Output 1 or 0 to High Impedance, t_{PHZ} , t_{PLZ} | $R_L = 1 \text{ k}\Omega$ | 5 | | 150 | 300 | |
| | | 10 | | 75 | 150 | |
| | | 15 | | 60 | 120 | |
| 3-State High Impedance to 1 or 0 Output, t_{PZH} , t_{PZL} | $R_L = 1 \text{ k}\Omega$ | 5 | | 150 | 300 | |
| | | 10 | | 75 | 150 | |
| | | 15 | | 60 | 120 | |
| Transition Time, t_{THL} , t_{TLH} | | 5 | | 100 | 200 | ns |
| | | 10 | | 50 | 100 | |
| | | 15 | | 40 | 80 | |
| Maximum Clock Input Frequency, f_{CL} | | 5 | 3 | 6 | | MHz |
| | | 10 | 6 | 12 | | |
| | | 15 | 8 | 16 | | |
| Minimum Clock Pulse Width, t_W | | 5 | | 100 | 200 | ns |
| | | 10 | | 50 | 100 | |
| | | 15 | | 40 | 80 | |
| Maximum Clock Input Rise or Fall Time, t_{rcl} , t_{fcl} | | 5 | 15 | - | - | μs |
| | | 10 | 5 | - | - | |
| | | 15 | 5 | - | - | |
| Minimum Reset Pulse Width, t_W | | 5 | - | 60 | 120 | ns |
| | | 10 | - | 25 | 50 | |
| | | 15 | - | 20 | 40 | |
| Minimum Data Setup Time, t_S | | 5 | - | 100 | 200 | ns |
| | | 10 | - | 40 | 80 | |
| | | 15 | - | 30 | 60 | |
| Minimum Data Input Disable Setup Time, t_S | | 5 | - | 90 | 180 | ns |
| | | 10 | - | 50 | 100 | |
| | | 15 | - | 35 | 70 | |
| Input Capacitance, C_{IN} | Any Input | - | - | 5 | 7.5 | pF |

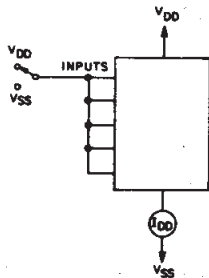

Fig. 11 – Quiescent device current test circuit.

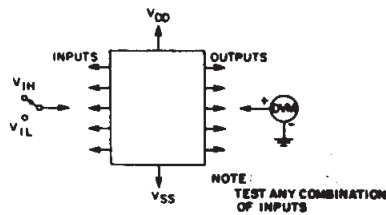

Fig. 12 – Input voltage test circuit.

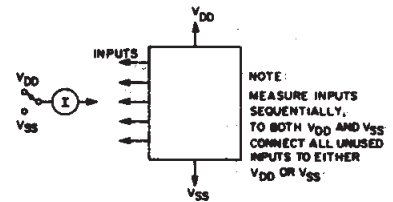

Fig. 13 – Input current test circuit.

CD4076B Types

STATIC ELECTRICAL CHARACTERISTICS

| CHARACTERISTIC | CONDITIONS | | | LIMITS AT INDICATED TEMPERATURES (°C) | | | | | | | UNITS |
|--|-----------------------|------------------------|------------------------|---------------------------------------|-------|-------|-------|-------|-------------------|------|-------|
| | V _O (V) | V _{IN} (V) | V _{DD} (V) | -55 | -40 | +85 | +125 | +25 | | | |
| | | | | | | | | Min. | Typ. | Max. | |
| Quiescent Device Current, I _{DD} Max. | — | 0,5 | 5 | 5 | 5 | 150 | 150 | — | 0.04 | 5 | μA |
| | — | 0,10 | 10 | 10 | 10 | 300 | 300 | — | 0.04 | 10 | |
| | — | 0,15 | 15 | 20 | 20 | 600 | 600 | — | 0.04 | 20 | |
| | — | 0,20 | 20 | 100 | 100 | 3000 | 3000 | — | 0.08 | 100 | |
| Output Low (Sink) Current I _{OL} Min. | 0.4 | 0,5 | 5 | 0.64 | 0.61 | 0.42 | 0.36 | 0.51 | 1 | — | mA |
| | 0.5 | 0,10 | 10 | 1.6 | 1.5 | 1.1 | 0.9 | 1.3 | 2.6 | — | |
| | 1.5 | 0,15 | 15 | 4.2 | 4 | 2.8 | 2.4 | 3.4 | 6.8 | — | |
| Output High (Source) Current, I _{OH} Min. | 4.6 | 0,5 | 5 | -0.64 | -0.61 | -0.42 | -0.36 | -0.51 | -1 | — | mA |
| | 2.5 | 0,5 | 5 | -2 | -1.8 | -1.3 | -1.15 | -1.6 | -3.2 | — | |
| | 9.5 | 0,10 | 10 | -1.6 | -1.5 | -1.1 | -0.9 | -1.3 | -2.6 | — | |
| | 13.5 | 0,15 | 15 | -4.2 | -4 | -2.8 | -2.4 | -3.4 | -6.8 | — | |
| Output Voltage: Low-Level, V _{OL} Max. | — | 0,5 | 5 | 0.05 | | | | — | 0 | 0.05 | V |
| | — | 0,10 | 10 | 0.05 | | | | — | 0 | 0.05 | |
| | — | 0,15 | 15 | 0.05 | | | | — | 0 | 0.05 | |
| Output Voltage: High-Level, V _{OH} Min. | — | 0,5 | 5 | 4.95 | | | | 4.95 | 5 | — | V |
| | — | 0,10 | 10 | 9.95 | | | | 9.95 | 10 | — | |
| | — | 0,15 | 15 | 14.95 | | | | 14.95 | 15 | — | |
| Input Low Voltage, V _{IL} Max. | 0.5, 4.5 | — | 5 | 1.5 | | | | — | — | 1.5 | V |
| | 1.9 | — | 10 | 3 | | | | — | — | 3 | |
| | 1.5, 13.5 | — | 15 | 4 | | | | — | — | 4 | |
| Input High Voltage, V _{IH} Min. | 0.5, 4.5 | — | 5 | 3.5 | | | | 3.5 | — | — | V |
| | 1.9 | — | 10 | 7 | | | | 7 | — | — | |
| | 1.5, 13.5 | — | 15 | 11 | | | | 11 | — | — | |
| Input Current I _{IN} Max. | — | 0,18 | 18 | ±0.1 | ±0.1 | ±1 | ±1 | — | ±10 ⁻⁵ | ±0.1 | μA |
| 3-State Output Leakage Current I _{OUT} Max. | 0,18 | 0,18 | 18 | ±0.4 | ±0.4 | ±12 | ±12 | — | ±10 ⁻⁴ | ±0.4 | μA |

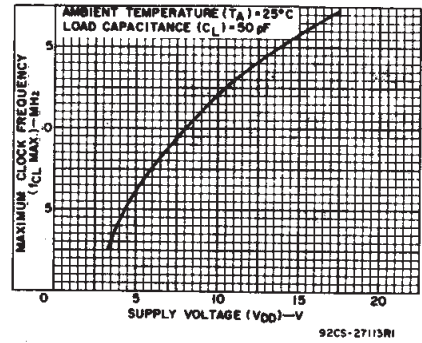

Fig.9 — Typical maximum clock input frequency vs. supply voltage.

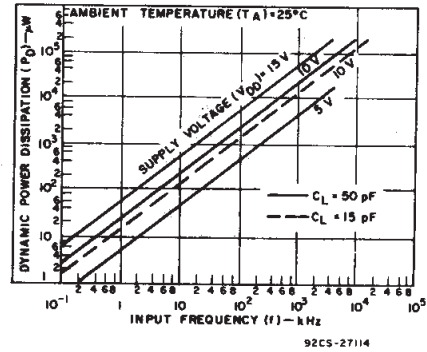
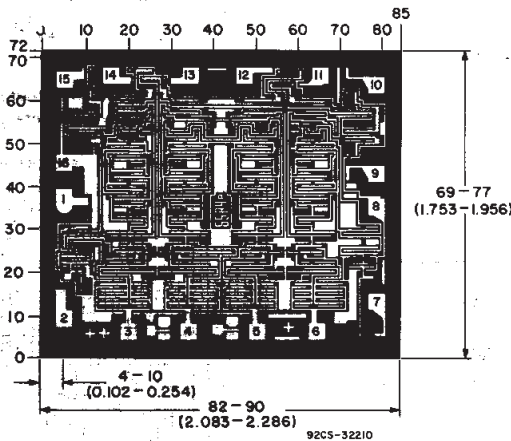

Fig.10 — Typical dynamic power dissipation vs. frequency.



Dimensions and pad layout for CD4076BH

Dimensions in parentheses are in millimeters and are derived from the basic inch dimensions as indicated. Grid graduations are in mils (10⁻³ inch).

3
COMMERCIAL CMOS
HIGH VOLTAGE ICs

PACKAGING INFORMATION

| Orderable Device | Status (1) | Package Type | Package Drawing | Pins | Package Qty | Eco Plan (2) | Lead/Ball Finish (6) | MSL Peak Temp (3) | Op Temp (°C) | Device Marking (4/5) | Samples |
|------------------|---------------|--------------|--------------------|------|----------------|----------------------------|-------------------------|----------------------|--------------|-------------------------|-------------------------|
| CD4076BE | ACTIVE | PDIP | N | 16 | 25 | Green (RoHS & no Sb/Br) | CU NIPDAU | N / A for Pkg Type | -55 to 125 | CD4076BE | Samples |
| CD4076BF | ACTIVE | CDIP | J | 16 | 1 | TBD | A42 | N / A for Pkg Type | -55 to 125 | CD4076BF | Samples |
| CD4076BF3A | ACTIVE | CDIP | J | 16 | 1 | TBD | A42 | N / A for Pkg Type | -55 to 125 | CD4076BF3A | Samples |
| CD4076BM | ACTIVE | SOIC | D | 16 | 40 | Green (RoHS & no Sb/Br) | CU NIPDAU | Level-1-260C-UNLIM | -55 to 125 | CD4076BM | Samples |
| CD4076BMT | ACTIVE | SOIC | D | 16 | 250 | Green (RoHS & no Sb/Br) | CU NIPDAU | Level-1-260C-UNLIM | -55 to 125 | CD4076BM | Samples |
| CD4076BPW | ACTIVE | TSSOP | PW | 16 | 90 | Green (RoHS & no Sb/Br) | CU NIPDAU | Level-1-260C-UNLIM | -55 to 125 | CM076B | Samples |

(1) The marketing status values are defined as follows:

ACTIVE: Product device recommended for new designs.

LIFEBUY: TI has announced that the device will be discontinued, and a lifetime-buy period is in effect.

NRND: Not recommended for new designs. Device is in production to support existing customers, but TI does not recommend using this part in a new design.

PREVIEW: Device has been announced but is not in production. Samples may or may not be available.

OBSOLETE: TI has discontinued the production of the device.

(2) **RoHS:** TI defines "RoHS" to mean semiconductor products that are compliant with the current EU RoHS requirements for all 10 RoHS substances, including the requirement that RoHS substance do not exceed 0.1% by weight in homogeneous materials. Where designed to be soldered at high temperatures, "RoHS" products are suitable for use in specified lead-free processes. TI may reference these types of products as "Pb-Free".

RoHS Exempt: TI defines "RoHS Exempt" to mean products that contain lead but are compliant with EU RoHS pursuant to a specific EU RoHS exemption.

Green: TI defines "Green" to mean the content of Chlorine (Cl) and Bromine (Br) based flame retardants meet JS709B low halogen requirements of <=1000ppm threshold. Antimony trioxide based flame retardants must also meet the <=1000ppm threshold requirement.

(3) MSL, Peak Temp. - The Moisture Sensitivity Level rating according to the JEDEC industry standard classifications, and peak solder temperature.

(4) There may be additional marking, which relates to the logo, the lot trace code information, or the environmental category on the device.

(5) Multiple Device Markings will be inside parentheses. Only one Device Marking contained in parentheses and separated by a "~" will appear on a device. If a line is indented then it is a continuation of the previous line and the two combined represent the entire Device Marking for that device.

(6) Lead/Ball Finish - Orderable Devices may have multiple material finish options. Finish options are separated by a vertical ruled line. Lead/Ball Finish values may wrap to two lines if the finish value exceeds the maximum column width.

Important Information and Disclaimer: The information provided on this page represents TI's knowledge and belief as of the date that it is provided. TI bases its knowledge and belief on information provided by third parties, and makes no representation or warranty as to the accuracy of such information. Efforts are underway to better integrate information from third parties. TI has taken and continues to take reasonable steps to provide representative and accurate information but may not have conducted destructive testing or chemical analysis on incoming materials and chemicals. TI and TI suppliers consider certain information to be proprietary, and thus CAS numbers and other limited information may not be available for release.

In no event shall TI's liability arising out of such information exceed the total purchase price of the TI part(s) at issue in this document sold by TI to Customer on an annual basis.

OTHER QUALIFIED VERSIONS OF CD4076B, CD4076B-MIL :

- Catalog: [CD4076B](#)
- Military: [CD4076B-MIL](#)

NOTE: Qualified Version Definitions:

- Catalog - TI's standard catalog product
- Military - QML certified for Military and Defense Applications

J (R-GDIP-T**)

14 LEADS SHOWN

CERAMIC DUAL IN-LINE PACKAGE



| DIM \ PINS ** | 14 | 16 | 18 | 20 |
|---------------|------------------------|------------------------|------------------------|------------------------|
| A | 0.300 (7,62) BSC | 0.300 (7,62) BSC | 0.300 (7,62) BSC | 0.300 (7,62) BSC |
| B MAX | 0.785 (19,94) | .840 (21,34) | 0.960 (24,38) | 1.060 (26,92) |
| B MIN | — | — | — | — |
| C MAX | 0.300 (7,62) | 0.300 (7,62) | 0.310 (7,87) | 0.300 (7,62) |
| C MIN | 0.245 (6,22) | 0.245 (6,22) | 0.220 (5,59) | 0.245 (6,22) |



4040083/F 03/03

- NOTES:
- All linear dimensions are in inches (millimeters).
 - This drawing is subject to change without notice.
 - This package is hermetically sealed with a ceramic lid using glass frit.
 - Index point is provided on cap for terminal identification only on press ceramic glass frit seal only.
 - Falls within MIL STD 1835 GDIP1-T14, GDIP1-T16, GDIP1-T18 and GDIP1-T20.

N (R-PDIP-T**)

PLASTIC DUAL-IN-LINE PACKAGE

16 PINS SHOWN





- NOTES:
- A. All linear dimensions are in inches (millimeters).
 - B. This drawing is subject to change without notice.
 - Falls within JEDEC MS-001, except 18 and 20 pin minimum body length (Dim A).
 - The 20 pin end lead shoulder width is a vendor option, either half or full width.

D (R-PDSO-G16)

PLASTIC SMALL OUTLINE



4040047-6/M 06/11

- NOTES:
- A. All linear dimensions are in inches (millimeters).
 - B. This drawing is subject to change without notice.
 -  C. Body length does not include mold flash, protrusions, or gate burrs. Mold flash, protrusions, or gate burrs shall not exceed 0.006 (0,15) each side.
 -  D. Body width does not include interlead flash. Interlead flash shall not exceed 0.017 (0,43) each side.
 - E. Reference JEDEC MS-012 variation AC.

D (R-PDSO-G16)

PLASTIC SMALL OUTLINE



- NOTES:
- All linear dimensions are in millimeters.
 - This drawing is subject to change without notice.
 - Publication IPC-7351 is recommended for alternate designs.
 - Laser cutting apertures with trapezoidal walls and also rounding corners will offer better paste release. Customers should contact their board assembly site for stencil design recommendations. Refer to IPC-7525 for other stencil recommendations.
 - Customers should contact their board fabrication site for solder mask tolerances between and around signal pads.



4220204/A 02/2017

NOTES:

1. All linear dimensions are in millimeters. Any dimensions in parenthesis are for reference only. Dimensioning and tolerancing per ASME Y14.5M.
2. This drawing is subject to change without notice.
3. This dimension does not include mold flash, protrusions, or gate burrs. Mold flash, protrusions, or gate burrs shall not exceed 0.15 mm per side.
4. This dimension does not include interlead flash. Interlead flash shall not exceed 0.25 mm per side.
5. Reference JEDEC registration MO-153.

EXAMPLE BOARD LAYOUT

PW0016A

TSSOP - 1.2 mm max height

SMALL OUTLINE PACKAGE



LAND PATTERN EXAMPLE
EXPOSED METAL SHOWN
SCALE: 10X



SOLDER MASK DETAILS

4220204/A 02/2017

NOTES: (continued)

- 6. Publication IPC-7351 may have alternate designs.
- 7. Solder mask tolerances between and around signal pads can vary based on board fabrication site.

EXAMPLE STENCIL DESIGN

PW0016A

TSSOP - 1.2 mm max height

SMALL OUTLINE PACKAGE



SOLDER PASTE EXAMPLE
BASED ON 0.125 mm THICK STENCIL
SCALE: 10X

4220204/A 02/2017

NOTES: (continued)

8. Laser cutting apertures with trapezoidal walls and rounded corners may offer better paste release. IPC-7525 may have alternate design recommendations.
9. Board assembly site may have different recommendations for stencil design.

IMPORTANT NOTICE AND DISCLAIMER

TI PROVIDES TECHNICAL AND RELIABILITY DATA (INCLUDING DATASHEETS), DESIGN RESOURCES (INCLUDING REFERENCE DESIGNS), APPLICATION OR OTHER DESIGN ADVICE, WEB TOOLS, SAFETY INFORMATION, AND OTHER RESOURCES "AS IS" AND WITH ALL FAULTS, AND DISCLAIMS ALL WARRANTIES, EXPRESS AND IMPLIED, INCLUDING WITHOUT LIMITATION ANY IMPLIED WARRANTIES OF MERCHANTABILITY, FITNESS FOR A PARTICULAR PURPOSE OR NON-INFRINGEMENT OF THIRD PARTY INTELLECTUAL PROPERTY RIGHTS.

These resources are intended for skilled developers designing with TI products. You are solely responsible for (1) selecting the appropriate TI products for your application, (2) designing, validating and testing your application, and (3) ensuring your application meets applicable standards, and any other safety, security, or other requirements. These resources are subject to change without notice. TI grants you permission to use these resources only for development of an application that uses the TI products described in the resource. Other reproduction and display of these resources is prohibited. No license is granted to any other TI intellectual property right or to any third party intellectual property right. TI disclaims responsibility for, and you will fully indemnify TI and its representatives against, any claims, damages, costs, losses, and liabilities arising out of your use of these resources.

TI's products are provided subject to TI's Terms of Sale (www.ti.com/legal/termsofsale.html) or other applicable terms available either on ti.com or provided in conjunction with such TI products. TI's provision of these resources does not expand or otherwise alter TI's applicable warranties or warranty disclaimers for TI products.

Mailing Address: Texas Instruments, Post Office Box 655303, Dallas, Texas 75265
Copyright © 2018, Texas Instruments Incorporated

Looking for pricing, stock, or lifecycle information?

Click below to explore more details on WIN SOURCE:

 [View CD4076BE](#) on WIN SOURCE

 [Texas Instruments](#) Information

Optimize Your Supply Chain with WIN SOURCE Solutions

-  Global Sourcing Solution
-  Obsolete Management
-  Cost Control Management
-  Shortage Management
-  Alternative Solution
-  Excess Inventory Management