

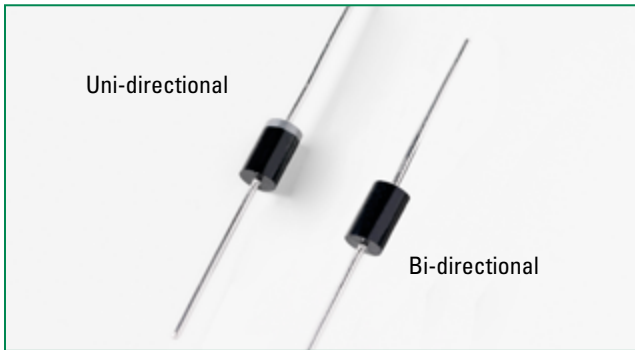



**THE DATASHEET OF
1.5KE200CA**



1.5KE Series



Agency Approvals

| AGENCY | AGENCY FILE NUMBER |
|---|--------------------|
|  | E230531 |

Maximum Ratings and Thermal Characteristics (T_A = 25°C unless otherwise noted)

| Parameter | Symbol | Value | Unit |
|--|-----------------------------------|------------|------|
| Peak Pulse Power Dissipation by 10/1000µs Test Waveform (Fig.2) (Note 1), (Note 4) | P _{PPM} | 1500 | W |
| Steady State Power Dissipation on Infinite Heat Sink at T _L = 75°C | P _D | 6.5 | W |
| Peak Forward Surge Current, 8.3ms Single Half Sine Wave Unidirectional Only (Note 2) | I _{FSM} | 200 | A |
| Maximum Instantaneous Forward Voltage at 100A for Unidirectional Only (Note 3) | V _F | 3.5/5.0 | V |
| Operating Junction and Storage Temperature Range | T _J , T _{STG} | -55 to 175 | °C |
| Typical Thermal Resistance Junction to Lead | R _{θJL} | 15 | °C/W |
| Typical Thermal Resistance Junction to Ambient | R _{θJA} | 75 | °C/W |

Notes:

1. Non-repetitive current pulse, per Fig. 4 and derated above T_J (initial) = 25°C per Fig. 3.
2. Measured on 8.3ms single half sine wave or equivalent square wave, duty cycle = 4 per minute maximum.
3. V_F < 3.5V for single die parts and V_F < 5.0V for stacked-die parts.
4. The P_{PPM} of stacked-die parts is 2kW and please contact littelfuse for the detail stacked-die parts.

Functional Diagram

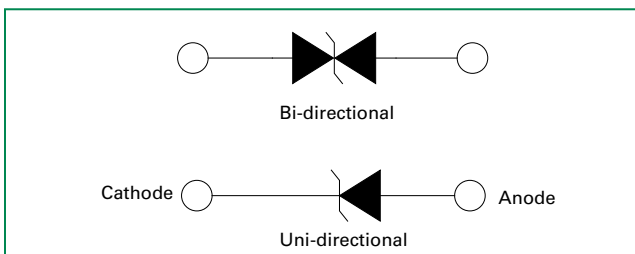

Description

The 1.5KE Series is designed specifically to protect sensitive electronic equipment from voltage transients induced by lightning and other transient voltage events.

Features

- 1500W peak pulse capability at 10/1000µs waveform, repetition rate (duty cycles): 0.01 %
- Glass passivated chip junction in DO-201 Package
- Fast response time: typically less than 1.0ps from 0 Volts to BV min
- Excellent clamping capability
- Typical failure mode is short from over-specified voltage or current
- Whisker test is conducted based on JEDEC JESD201A per its table 4a and 4c
- IEC-61000-4-2 ESD 30kV(Air), 30kV (Contact)
- ESD protection of data lines in accordance with IEC 61000-4-2
- EFT protection of data lines in accordance with IEC 61000-4-4
- Low incremental surge resistance
- Typical I_R less than 1µA when V_{BR} min > 12V
- High temperature to reflow soldering guaranteed: 260°C/40sec / 0.375"/(9.5mm) lead length, 5 lbs., (2.3kg) tension
- V_{BR} @ T_J = V_{BR} @ 25°C x (1 + α T x (T_J - 25)) (α T: Temperature Coefficient, typical value is 0.1%)
- Plastic package is flammability rated V-0 per Underwriters Laboratories
- Matte tin lead-free plated
- Halogen free and RoHS compliant
- Pb-free E3 means 2nd level interconnect is Pb-free and the terminal finish material is tin(Sn) (IPC/JEDEC J-STD-609A.01)

Applications

TVS devices are ideal for the protection of I/O interfaces, V_{CC} bus and other vulnerable circuits used in telecom, computer, industrial and consumer electronic applications.

Additional Information



Datasheet



Resources



Samples

Electrical Characteristics (T_A=25°C unless otherwise noted)

| Part Number (Uni) | Part Number (Bi) | Reverse Stand off Voltage V _R (Volts) | Breakdown Voltage V _{BR} (Volts) @ I _T | | Test Current I _T (mA) | Maximum Clamping Voltage V _C @ I _{pp} (Volts) | Maximum Peak Pulse Current I _{pp} (A) | Maximum Reverse Leakage I _R @ V _R (µA) | Agency Approval  |
|-------------------|------------------|--|--|--------|----------------------------------|---|--|--|---|
| | | | MIN | MAX | | | | | |
| 1.5KE6.8A | 1.5KE6.8CA | 5.80 | 6.45 | 7.14 | 10 | 10.5 | 144.8 | 1000 | X |
| 1.5KE75A | 1.5KE75CA | 6.40 | 7.13 | 7.88 | 10 | 11.3 | 134.5 | 500 | X |
| 1.5KE8.2A | 1.5KE8.2CA | 7.02 | 7.79 | 8.61 | 10 | 12.1 | 125.6 | 200 | X |
| 1.5KE9.1A | 1.5KE9.1CA | 7.78 | 8.65 | 9.50 | 1 | 13.4 | 113.4 | 50 | X |
| 1.5KE10A | 1.5KE10CA | 8.55 | 9.50 | 10.50 | 1 | 14.5 | 104.8 | 10 | X |
| 1.5KE11A | 1.5KE11CA | 9.40 | 10.50 | 11.60 | 1 | 15.6 | 97.4 | 5 | X |
| 1.5KE12A | 1.5KE12CA | 10.20 | 11.40 | 12.60 | 1 | 16.7 | 91.0 | 5 | X |
| 1.5KE13A | 1.5KE13CA | 11.10 | 12.40 | 13.70 | 1 | 18.2 | 83.5 | 1 | X |
| 1.5KE15A | 1.5KE15CA | 12.80 | 14.30 | 15.80 | 1 | 21.2 | 71.7 | 1 | X |
| 1.5KE16A | 1.5KE16CA | 13.60 | 15.20 | 16.80 | 1 | 22.5 | 67.6 | 1 | X |
| 1.5KE18A | 1.5KE18CA | 15.30 | 17.10 | 18.90 | 1 | 25.2 | 60.3 | 1 | X |
| 1.5KE20A | 1.5KE20CA | 17.10 | 19.00 | 21.00 | 1 | 27.7 | 54.9 | 1 | X |
| 1.5KE22A | 1.5KE22CA | 18.80 | 20.90 | 23.10 | 1 | 30.6 | 49.7 | 1 | X |
| 1.5KE24A | 1.5KE24CA | 20.50 | 22.80 | 25.20 | 1 | 33.2 | 45.8 | 1 | X |
| 1.5KE27A | 1.5KE27CA | 23.10 | 25.70 | 28.40 | 1 | 37.5 | 40.5 | 1 | X |
| 1.5KE30A | 1.5KE30CA | 25.60 | 28.50 | 31.50 | 1 | 41.4 | 36.7 | 1 | X |
| 1.5KE33A | 1.5KE33CA | 28.20 | 31.40 | 34.70 | 1 | 45.7 | 33.3 | 1 | X |
| 1.5KE36A | 1.5KE36CA | 30.80 | 34.20 | 37.80 | 1 | 49.9 | 30.5 | 1 | X |
| 1.5KE39A | 1.5KE39CA | 33.30 | 37.10 | 41.00 | 1 | 53.9 | 28.2 | 1 | X |
| 1.5KE43A | 1.5KE43CA | 36.80 | 40.90 | 45.20 | 1 | 59.3 | 25.6 | 1 | X |
| 1.5KE47A | 1.5KE47CA | 40.20 | 44.70 | 49.40 | 1 | 64.8 | 23.5 | 1 | X |
| 1.5KE51A | 1.5KE51CA | 43.60 | 48.50 | 53.60 | 1 | 70.1 | 21.7 | 1 | X |
| 1.5KE56A | 1.5KE56CA | 47.80 | 53.20 | 58.80 | 1 | 77.0 | 19.7 | 1 | X |
| 1.5KE62A | 1.5KE62CA | 53.00 | 58.90 | 65.10 | 1 | 85.0 | 17.9 | 1 | X |
| 1.5KE68A | 1.5KE68CA | 58.10 | 64.60 | 71.40 | 1 | 92.0 | 16.5 | 1 | X |
| 1.5KE75A | 1.5KE75CA | 64.10 | 71.30 | 78.80 | 1 | 103.0 | 14.8 | 1 | X |
| 1.5KE82A | 1.5KE82CA | 70.10 | 77.90 | 86.10 | 1 | 113.0 | 13.5 | 1 | X |
| 1.5KE91A | 1.5KE91CA | 77.80 | 86.50 | 95.50 | 1 | 125.0 | 12.2 | 1 | X |
| 1.5KE100A | 1.5KE100CA | 85.50 | 95.00 | 105.00 | 1 | 137.0 | 11.1 | 1 | X |
| 1.5KE110A | 1.5KE110CA | 94.00 | 105.00 | 116.00 | 1 | 152.0 | 10.0 | 1 | X |
| 1.5KE120A | 1.5KE120CA | 102.00 | 114.00 | 126.00 | 1 | 165.0 | 9.2 | 1 | X |
| 1.5KE130A | 1.5KE130CA | 111.00 | 124.00 | 137.00 | 1 | 179.0 | 8.5 | 1 | X |
| 1.5KE150A | 1.5KE150CA | 128.00 | 143.00 | 158.00 | 1 | 207.0 | 7.3 | 1 | X |
| 1.5KE160A | 1.5KE160CA | 136.00 | 152.00 | 168.00 | 1 | 219.0 | 6.9 | 1 | X |
| 1.5KE170A | 1.5KE170CA | 145.00 | 162.00 | 179.00 | 1 | 234.0 | 6.5 | 1 | X |
| 1.5KE180A | 1.5KE180CA | 154.00 | 171.00 | 189.00 | 1 | 246.0 | 6.2 | 1 | X |
| 1.5KE200A | 1.5KE200CA | 171.00 | 190.00 | 210.00 | 1 | 274.0 | 5.5 | 1 | X |
| 1.5KE220A | 1.5KE220CA | 185.00 | 209.00 | 231.00 | 1 | 328.0 | 4.6 | 1 | X |
| 1.5KE250A | 1.5KE250CA | 214.00 | 237.00 | 263.00 | 1 | 344.0 | 4.4 | 1 | X |
| 1.5KE300A | 1.5KE300CA | 256.00 | 285.00 | 315.00 | 1 | 414.0 | 3.7 | 1 | X |
| 1.5KE320A | 1.5KE320CA | 273.00 | 304.00 | 336.00 | 1 | 441.0 | 3.5 | 1 | X |
| 1.5KE350A | 1.5KE350CA | 300.00 | 332.00 | 368.00 | 1 | 482.0 | 3.2 | 1 | X |
| 1.5KE400A | 1.5KE400CA | 342.00 | 380.00 | 420.00 | 1 | 548.0 | 2.8 | 1 | X |
| 1.5KE440A | 1.5KE440CA | 376.00 | 418.00 | 462.00 | 1 | 602.0 | 2.5 | 1 | X |
| 1.5KE480A | 1.5KE480CA | 408.00 | 456.00 | 504.00 | 1 | 658.0 | 2.3 | 1 | X |
| 1.5KE510A | 1.5KE510CA | 434.00 | 485.00 | 535.00 | 1 | 698.0 | 2.1 | 1 | X |
| 1.5KE530A | 1.5KE530CA | 451.00 | 503.50 | 556.50 | 1 | 725.0 | 2.1 | 1 | X |
| 1.5KE540A | 1.5KE540CA | 460.00 | 513.00 | 567.00 | 1 | 740.0 | 2.0 | 1 | X |
| 1.5KE550A | 1.5KE550CA | 468.00 | 522.50 | 577.50 | 1 | 760.0 | 2.0 | 1 | X |
| 1.5KE600A | 1.5KE600CA | 512.00 | 570.00 | 630.00 | 1 | 828.0 | 1.8 | 1 | X |

For bidirectional type having V_R of 10 volts and less, the I_R limit is double.

For parts without A, the V_{BR} is ± 10% and V_C is 5% higher than with A parts.

I-V Curve Characteristics

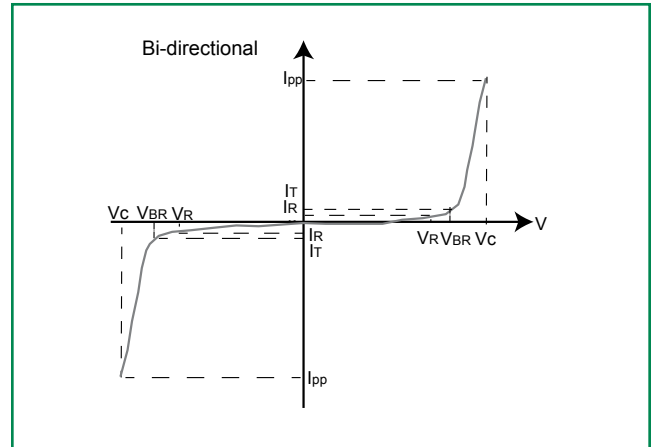
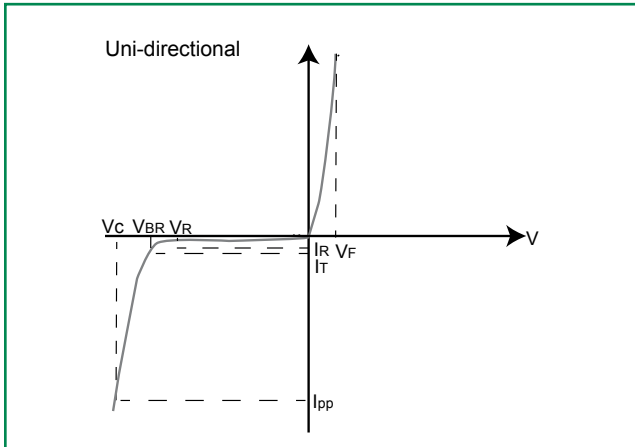

P_{PPM} Peak Pulse Power Dissipation – Max power dissipation

V_R Stand-off Voltage – Maximum voltage that can be applied to the TVS without operation

V_{BR} Breakdown Voltage – Maximum voltage that flows through the TVS at a specified test current (I_T)

V_C Clamping Voltage – Peak voltage measured across the TVS at a specified I_{ppm} (peak impulse current)

I_R Reverse Leakage Current – Current measured at V_R

V_F Forward Voltage Drop for Uni-directional

Ratings and Characteristic Curves ($T_A=25^\circ\text{C}$ unless otherwise noted)

Figure 1 - TVS Transients Clamping Waveform

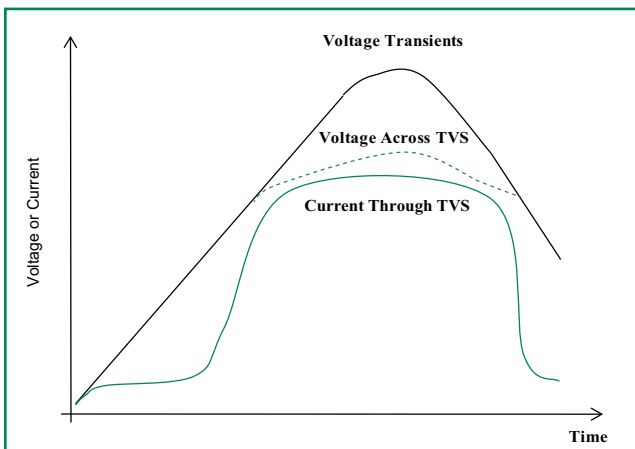
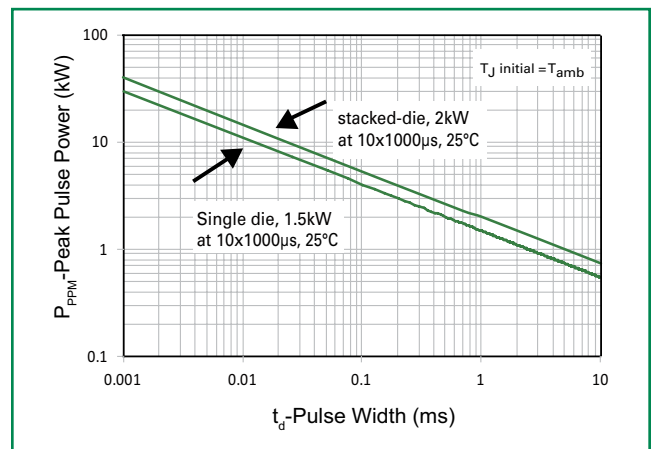

Figure 2 - Peak Pulse Power Rating



continues on next page.

Ratings and Characteristic Curves ($T_A=25^\circ\text{C}$ unless otherwise noted) (Continued)

Figure 3 - Peak Pulse Power Derating Curve

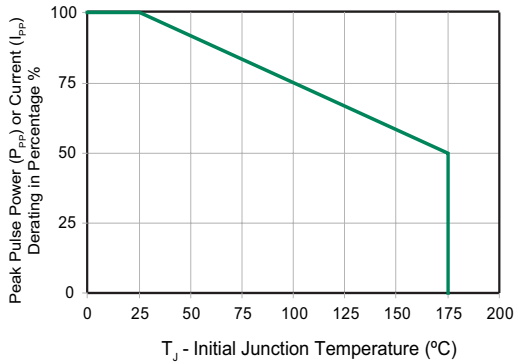

Figure 4 - Pulse Waveform

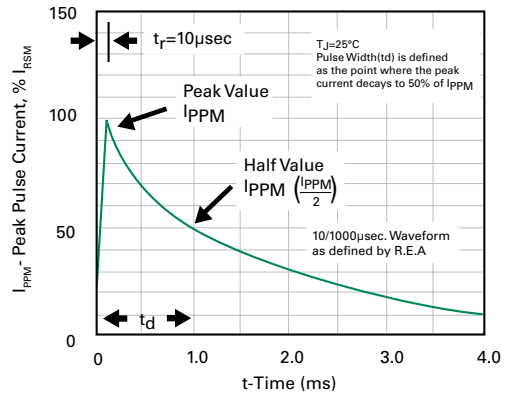

Figure 5 - Typical Junction Capacitance

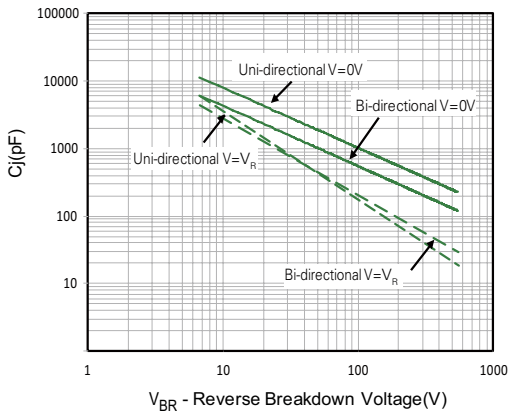

Figure 6 - Typical Transient Thermal Impedance

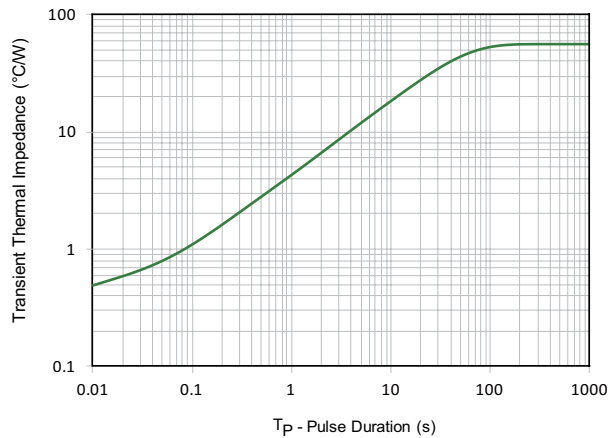

Figure 7 - Maximum Non-Repetitive Peak Forward Surge Current Uni-Directional Only

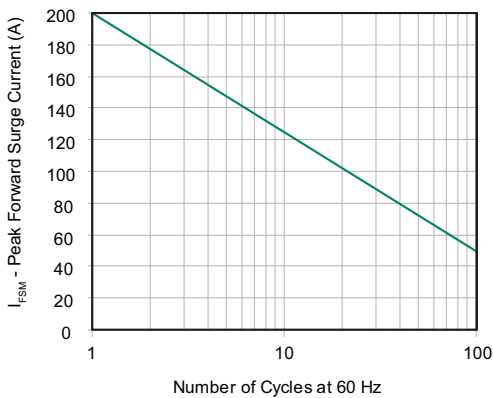
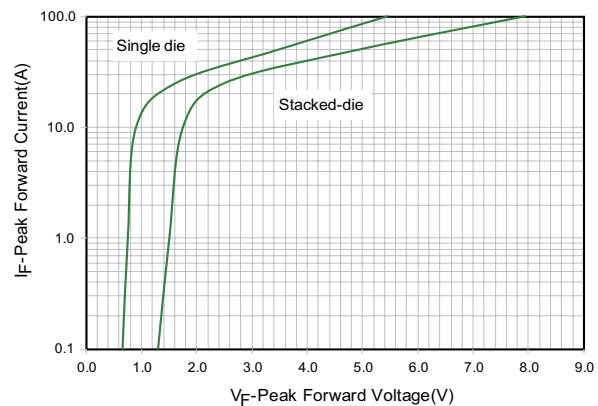
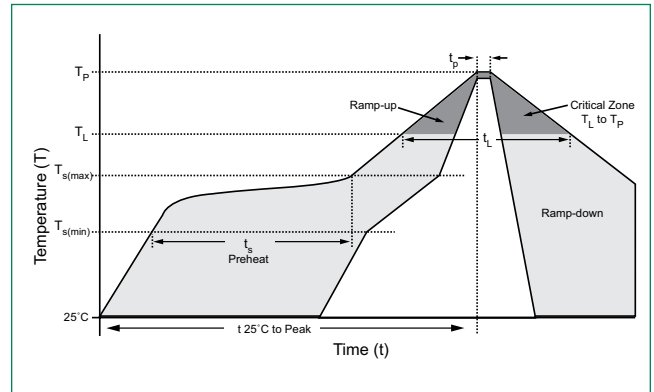

Figure 8 - Peak Forward Voltage Drop vs Peak Forward Current (Typical Values)



Soldering Parameters

| | | |
|--|------------------------------------|-------------------------|
| Reflow Condition | | Lead-free assembly |
| Pre Heat | - Temperature Min ($T_{s(min)}$) | 150°C |
| | - Temperature Max ($T_{s(max)}$) | 200°C |
| | - Time (min to max) (t_s) | 60 – 180 secs |
| Average ramp up rate (Liquidus Temp (T_A) to peak) | | 3°C/second max |
| $T_{s(max)}$ to T_A - Ramp-up Rate | | 3°C/second max |
| Reflow | - Temperature (T_A) (Liquidus) | 217°C |
| | - Time (min to max) (t_s) | 60 – 150 seconds |
| Peak Temperature (T_p) | | 260 ^{+0/-5} °C |
| Time within 5°C of actual peak Temperature (t_p) | | 20 – 40 seconds |
| Ramp-down Rate | | 6°C/second max |
| Time 25°C to peak Temperature (T_p) | | 8 minutes Max. |
| Do not exceed | | 260°C |



Flow/Wave Soldering (Solder Dipping)

| | |
|---------------------------|------------|
| Peak Temperature : | 265°C |
| Dipping Time : | 10 seconds |
| Soldering : | 1 time |

Physical Specifications

| | |
|-----------------|--|
| Weight | 0.045oz., 1.2g |
| Case | JEDEC DO-201 molded plastic body over passivated junction. |
| Polarity | Color band denotes the cathode except Bipolar. |
| Terminal | Matte Tin axial leads, solderable per JESD22-B102. |

Environmental Specifications

| | |
|----------------------------|-------------|
| High Temp. Storage | JESD22-A103 |
| HTRB | JESD22-A108 |
| Temperature Cycling | JESD22-A104 |
| H3TRB | JESD22-A101 |
| RSH | JESD22-B106 |

Dimensions

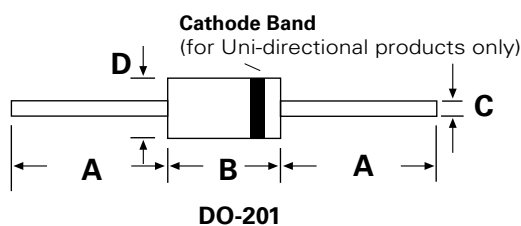

| Dimensions | Inches | | Millimeters | |
|------------|--------|-------|-------------|------|
| | Min | Max | Min | Max |
| A | 1.000 | - | 25.40 | - |
| B | 0.285 | 0.375 | 7.20 | 9.50 |
| C | 0.038 | 0.042 | 0.96 | 1.07 |
| D | 0.190 | 0.210 | 4.80 | 5.30 |

Part Numbering System

1.5KE xxxXXX

- OPTION CODE:**
 - BLANK** Reel Tape
 - B** Bulk Packaging
- TYPE CODE:**
 - A** Uni-Directional (5% V_{BR} Voltage Tolerance)
 - CA** Bi-Directional (5% V_{BR} Voltage Tolerance)
- V_{BR} VOLTAGE CODE**
 (Refer to the Electrical Characteristics table)
- SERIES CODE**

Part Marking System

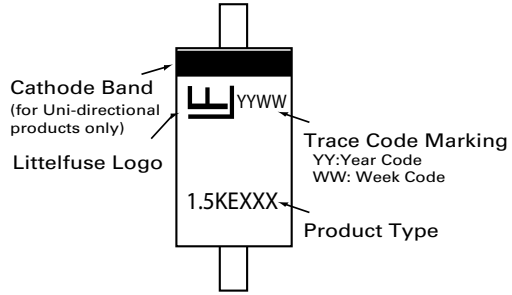

Packaging

| Part Number | Component Package | Quantity | Packaging Option | Packaging Specification |
|--------------|-------------------|----------|------------------|-------------------------|
| 1.5KExxxXX | DO-201 | 1200 | Tape & Reel | EIA STD RS-296 |
| 1.5KExxxXX-B | DO-201 | 500 | BULK | Littelfuse Spec. |

Tape and Reel Specification

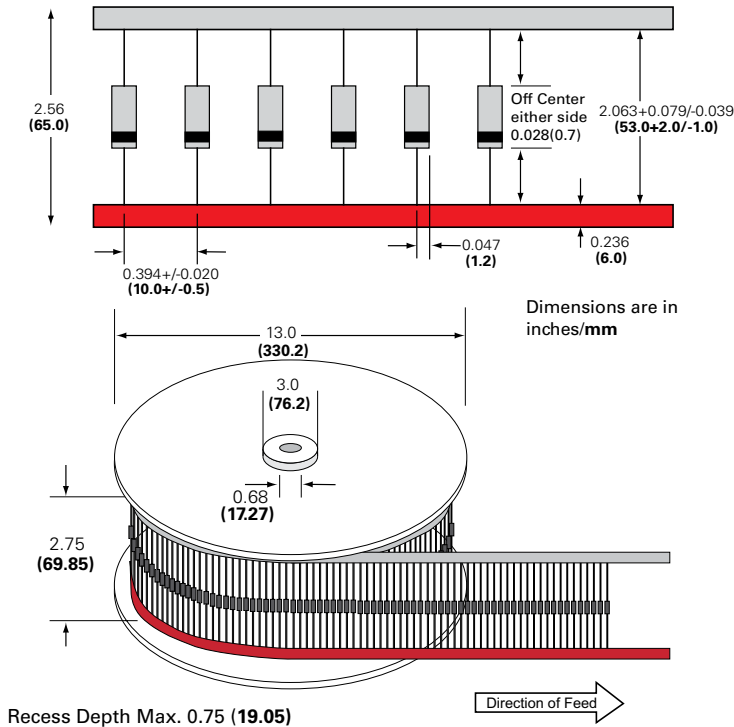

Looking for pricing, stock, or lifecycle information?

Click below to explore more details on WIN SOURCE:

 [View 1.5KE200CA on WIN SOURCE](#)

 [Littelfuse Inc. Information](#)

Optimize Your Supply Chain with WIN SOURCE Solutions

-  Global Sourcing Solution
-  Obsolete Management
-  Cost Control Management
-  Shortage Management
-  Alternative Solution
-  Excess Inventory Management