



**THE DATASHEET OF
CD4024BM96**



CD4020B, CD4024B, CD4040B Types

CMOS Ripple-Carry Binary Counter/Dividers

High-Voltage Types (20-Volt Rating)

CD4020B – 14 Stage

CD4024B – 7 Stage

CD4040B – 12 Stage

■ CD4020B, CD4024B, and CD4040B are ripple-carry binary counters. All counter stages are master-slave flip-flops. The state of a counter advances one count on the negative transition of each input pulse; a high level on the RESET line resets the counter to its all zeros state. Schmitt trigger action on the input-pulse line permits unlimited rise and fall times. All inputs and outputs are buffered.

The CD4020B and CD4040B types are supplied in 16-lead hermetic dual-in-line ceramic packages (F3A suffix), 16-lead dual-in-line plastic packages (E suffix), 16-lead small-outline packages (NSR suffix), and 16-lead thin shrink small-outline packages (PW and PWR suffixes). The CD4040B type also is supplied in 16-lead small-outline packages (M and M96 suffixes).

The CD4024B types are supplied in 14-lead hermetic dual-in-line ceramic packages (F3A suffix), 14-lead dual-in-line plastic packages (E suffix), 14-lead small-outline packages (M, MT, M96, and NSR suffixes), and 14-lead thin shrink small-outline packages (PW and PWR suffixes).

MAXIMUM RATINGS, Absolute-Maximum Values:
DC SUPPLY-VOLTAGE RANGE, (V_{DD})

Voltages referenced to V _{SS} Terminal	-0.5V to +20V
INPUT VOLTAGE RANGE, ALL INPUTS	-0.5V to V _{DD} +0.5V
DC INPUT CURRENT, ANY ONE INPUT	±10mA
POWER DISSIPATION PER PACKAGE (P _D):		
For T _A = -55°C to +100°C	500mW
For T _A = +100°C to +125°C	Derate Linearly at 12mW/°C to 200mW
DEVICE DISSIPATION PER OUTPUT TRANSISTOR		
FOR T _A = FULL PACKAGE-TEMPERATURE RANGE (All Package Types)	100mW
OPERATING-TEMPERATURE RANGE (T _A)	-55°C to +125°C
STORAGE TEMPERATURE RANGE (T _{stg})	-65°C to +150°C
LEAD TEMPERATURE (DURING SOLDERING):		
At distance 1/16 ± 1/32 inch (1.59 ± 0.79mm) from case for 10s max	+265°C

Features:

- Medium-speed operation
- Fully static operation
- Buffered inputs and outputs
- 100% tested for quiescent current at 20 V
- Standardized, symmetrical output characteristics
- Fully static operation
- Common reset
- 5-V, 10-V, and 15-V parametric ratings
- Maximum input current of 1 μA at 18 V over full package-temperature range; 100 nA at 18 V and 25°C
- Noise margin (over full package-temperature range):
 - 1 V at V_{DD} = 5 V
 - 2 V at V_{DD} = 10 V
 - 2.5 V at V_{DD} = 15 V
- Meets all requirements of JEDEC Tentative Standard No. 13B, "Standard Specifications for Description of 'B' Series CMOS Devices"

Applications:

- Control counters
- Timers
- Frequency dividers
- Time-delay circuits

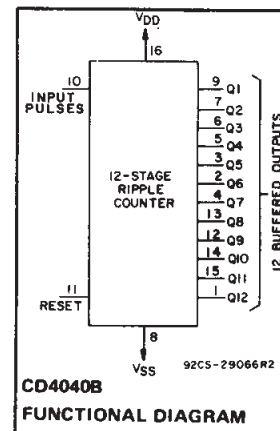
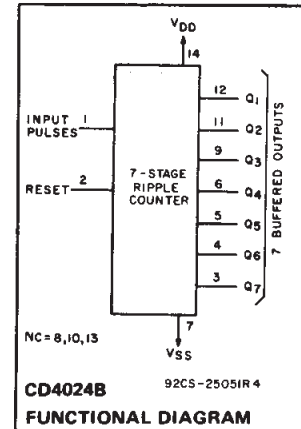
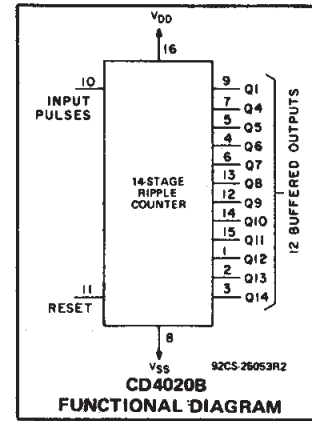

TERMINAL ASSIGNMENTS

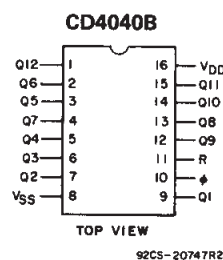
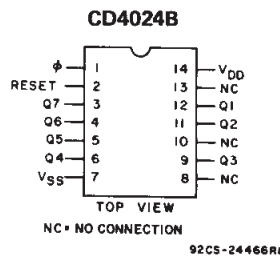
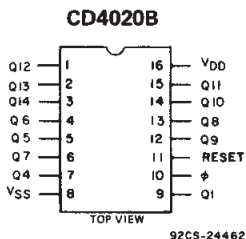

CD4020B, CD4024B, CD4040B Types

RECOMMENDED OPERATING CONDITIONS at $T_A = 25^\circ\text{C}$, Unless Otherwise Specified
 For maximum reliability, nominal operating conditions should be selected so that operation is always within the following ranges:

CHARACTERISTIC	V_{DD}	Min.	Max.	UNITS
Supply Voltage Range (at $T_A = \text{Full Package-Temperature Range}$)		3	18	V
Input-Pulse Frequency, f_ϕ	5 10 15	—	3.5 8 12	MHz
Input-Pulse Width, t_W	5 10 15	140 60 40	— — —	ns
Input-Pulse Rise or Fall Time, $t_{r\phi}, t_{f\phi}$	5 10 15	Unlimited		μs
Reset Pulse Width, t_W	5 10 15	200 80 60	—	ns
Reset Removal Time, t_{REM}	5 10 15	350 150 100	—	ns

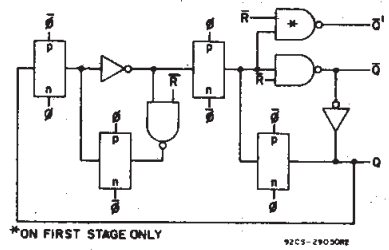

Fig. 4 - Detail of typical flip-flop stage.

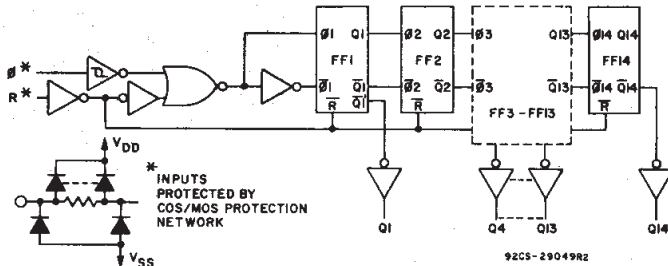

Fig. 1 - Logic diagram for CD4020B.

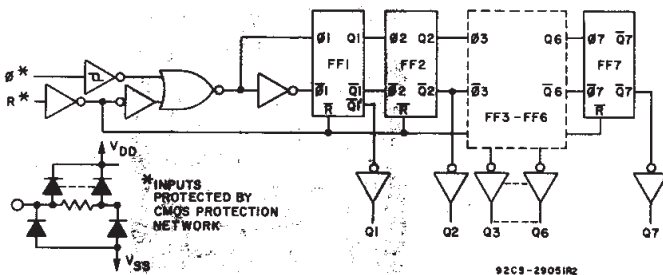

Fig. 2 - Logic diagram for CD4024B.

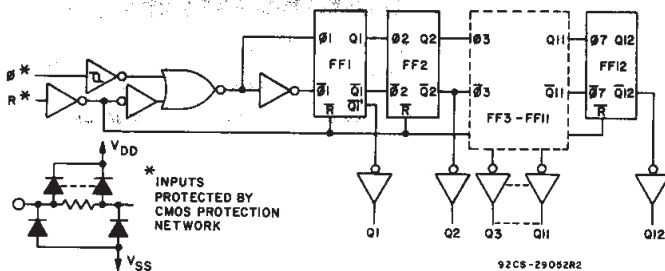

Fig. 3 - Logic diagram for CD4040B.

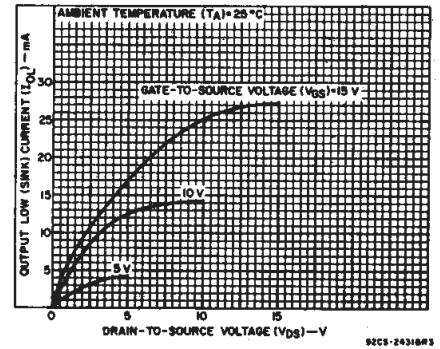

Fig. 5 - Typical output low (sink) current characteristics.

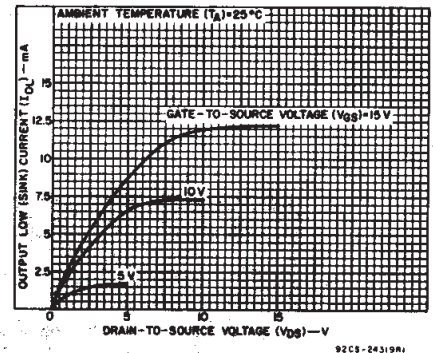

Fig. 6 - Minimum output low (sink) current characteristics.

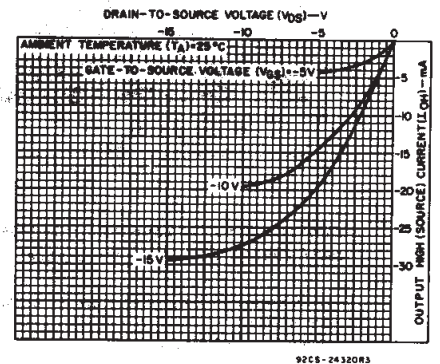

Fig. 7 - Typical output high (source) current characteristics.

3
COMMERCIAL CMOS
HIGH VOLTAGE ICs

CD4020B, CD4024B, CD4040B Types

STATIC ELECTRICAL CHARACTERISTICS

CHARACTERISTIC	CONDITIONS			LIMITS AT INDICATED TEMPERATURES (°C)							UNITS
	V _O (V)	V _{IN} (V)	V _{DD} (V)	-55	-40	+85	+125	+25			
								Min.	Typ.	Max.	
Quiescent Device Current, I _{DD} Max.	-	0,5	5	5	5	150	150	-	0.04	5	μA
	-	0,10	10	10	10	300	300	-	0.04	10	
	-	0,15	15	20	20	600	600	-	0.04	20	
	-	0,20	20	100	100	3000	3000	-	0.08	100	
Output Low (Sink) Current I _{OL} Min.	0.4	0,5	5	0.64	0.61	0.42	0.36	0.51	1	-	mA
	0.5	0,10	10	1.6	1.5	1.1	0.9	1.3	2.6	-	
	1.5	0,15	15	4.2	4	2.8	2.4	3.4	6.8	-	
Output High (Source) Current, I _{OH} Min.	4.6	0,5	5	-0.64	-0.61	-0.42	-0.36	-0.51	-1	-	mA
	2.5	0,5	5	-2	-1.8	-1.3	-1.15	-1.6	-3.2	-	
	9.5	0,10	10	-1.6	-1.5	-1.1	-0.9	-1.3	-2.6	-	
	13.5	0,15	15	-4.2	-4	-2.8	-2.4	-3.4	-6.8	-	
Output Voltage: Low-Level, V _{OL} Max.	-	0,5	5	0.05				-	0	0.05	V
	-	0,10	10	0.05				-	0	0.05	
	-	0,15	15	0.05				-	0	0.05	
Output Voltage: High-Level, V _{OH} Min.	-	0,5	5	4.95				4.95	5	-	V
	-	0,10	10	9.95				9.95	10	-	
	-	0,15	15	14.95				14.95	15	-	
Input Low Voltage, V _{IL} Max.	0.5, 4.5	-	5	1.5				-	-	1.5	V
	1, 9	-	10	3				-	-	3	
	1.5, 13.5	-	15	4				-	-	4	
Input High Voltage, V _{IH} Min.	0.5, 4.5	-	5	3.5				3.5	-	-	V
	1, 9	-	10	7				7	-	-	
	1.5, 13.5	-	15	11				11	-	-	
Input Current I _{IN} Max.	-	0,18	18	±0.1	±0.1	±1	±1	-	±10 ⁻⁵	±0.1	μA

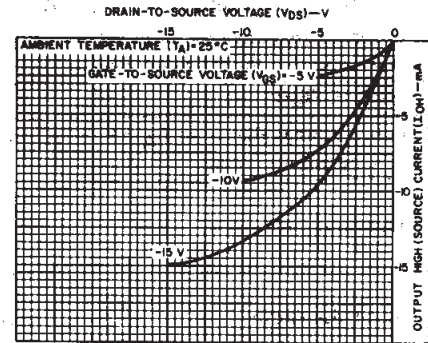

Fig. 8 - Minimum output high (source) current characteristics.

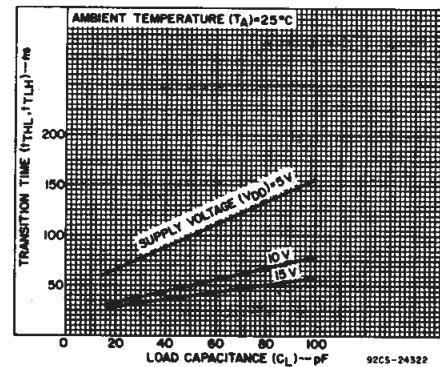
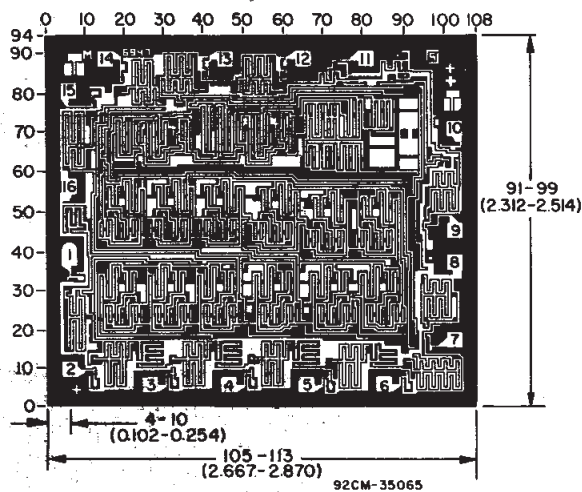
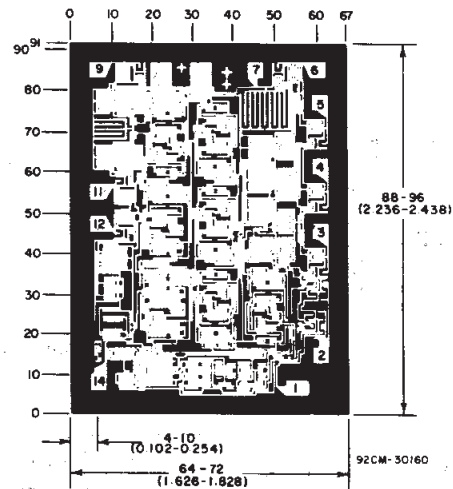

Fig. 9 - Typical transition time as a function of load capacitance.



Dimensions and Pad Layout for CD4020BH. Dimensions and pad layout for CD4040BH are identical.

Dimensions in parentheses are in millimeters and are derived from the basic inch dimensions as indicated. Grid graduations are in mils (10⁻³ inch).



Dimensions and Pad Layout for CD4024BH.

CD4020B, CD4024B, CD4040B Types

DYNAMIC ELECTRICAL CHARACTERISTICS at $T_A = 25^\circ\text{C}$, Input $t_r, t_f = 20 \text{ ns}$, $C_L = 50 \text{ pF}$, $R_L = 200 \text{ k}\Omega$

CHARACTERISTIC	TEST CONDITIONS	V_{DD} (V)	LIMITS			UNITS
			Min.	Typ.	Max.	
Input-Pulse Operation						
Propagation Delay Time, ϕ to Q_1 Out; t_{PHL}, t_{PLH}		5	—	180	360	ns
		10	—	80	160	
		15	—	65	130	
Q_n to Q_{n+1} ; t_{PHL}, t_{PLH}		5	—	100	330	ns
		10	—	40	80	
		15	—	30	60	
Transition Time, t_{THL}, t_{TLH}		5	—	100	200	ns
		10	—	50	100	
		15	—	40	80	
Minimum Input-Pulse Width, t_W		5	—	70	140	ns
		10	—	30	60	
		15	—	20	40	
Input-Pulse Rise or Fall Time, $t_{r\phi}, t_{f\phi}$		5	Unlimited			μs
		10				
		15				
Maximum Input-Pulse Frequency, f_ϕ		5	3.5	7	—	MHz
		10	8	16	—	
		15	12	24	—	
Input Capacitance, C_i	Any Input		—	5	7.5	pF
Reset Operation						
Propagation Delay Time, t_{PHL}		5	—	140	280	ns
		10	—	60	120	
		15	—	50	100	
Minimum Reset Pulse Width, t_W		5	—	100	200	ns
		10	—	40	80	
		15	—	30	60	
Reset Removal Time, t_{REM}		5	—	175	350	ns
		10	—	75	150	
		15	—	50	100	

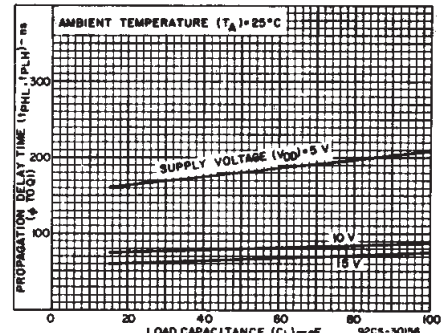

Fig. 10 – Typical propagation delay time as a function of load capacitance (ϕ to Q_1).

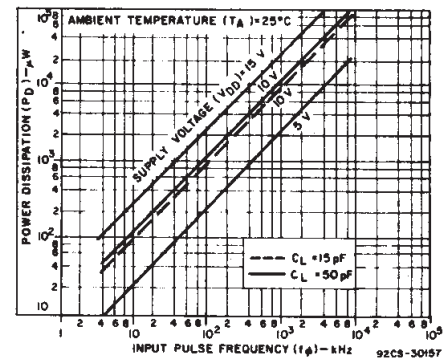

Fig. 11 – Typical dynamic power dissipation as a function of input pulse frequency for CD4020B.

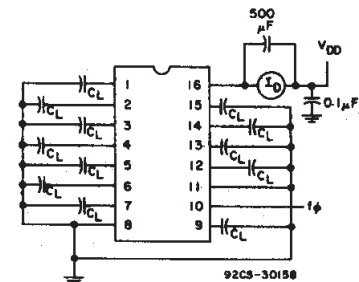

Fig. 12 – Dynamic power dissipation test circuit for CD4020B.

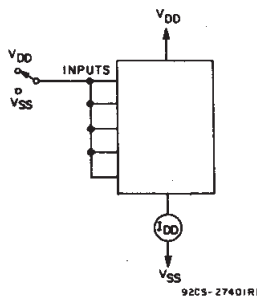

Fig. 13 – Quiescent device current test circuit.

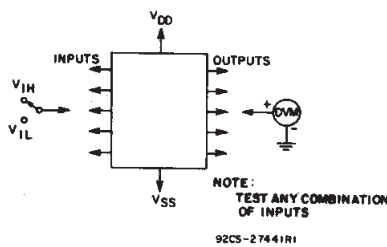

Fig. 14 – Input voltage test circuits.

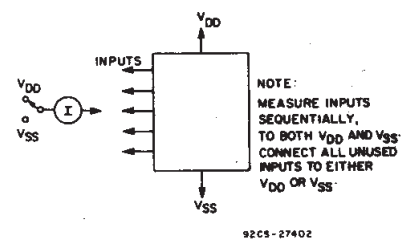

Fig. 15 – Input current test circuit.

3
COMMERCIAL CMOS
HIGH VOLTAGE ICs

PACKAGING INFORMATION

Orderable Device	Status (1)	Package Type	Package Drawing	Pins	Package Qty	Eco Plan (2)	Lead/Ball Finish (6)	MSL Peak Temp (3)	Op Temp (°C)	Device Marking (4/5)	Samples
CD4020BE	ACTIVE	PDIP	N	16	25	Green (RoHS & no Sb/Br)	CU NIPDAU	N / A for Pkg Type	-55 to 125	CD4020BE	Samples
CD4020BEE4	ACTIVE	PDIP	N	16	25	Green (RoHS & no Sb/Br)	CU NIPDAU	N / A for Pkg Type	-55 to 125	CD4020BE	Samples
CD4020BF	ACTIVE	CDIP	J	16	1	TBD	A42	N / A for Pkg Type	-55 to 125	CD4020BF	Samples
CD4020BF3A	ACTIVE	CDIP	J	16	1	TBD	A42	N / A for Pkg Type	-55 to 125	CD4020BF3A	Samples
CD4020BNSR	ACTIVE	SO	NS	16	2000	Green (RoHS & no Sb/Br)	CU NIPDAU	Level-1-260C-UNLIM	-55 to 125	CD4020B	Samples
CD4020BNSRG4	ACTIVE	SO	NS	16	2000	Green (RoHS & no Sb/Br)	CU NIPDAU	Level-1-260C-UNLIM	-55 to 125	CD4020B	Samples
CD4020BPW	ACTIVE	TSSOP	PW	16	90	Green (RoHS & no Sb/Br)	CU NIPDAU	Level-1-260C-UNLIM	-55 to 125	CM020B	Samples
CD4020BPWE4	ACTIVE	TSSOP	PW	16	90	Green (RoHS & no Sb/Br)	CU NIPDAU	Level-1-260C-UNLIM	-55 to 125	CM020B	Samples
CD4020BPWR	ACTIVE	TSSOP	PW	16	2000	Green (RoHS & no Sb/Br)	CU NIPDAU	Level-1-260C-UNLIM	-55 to 125	CM020B	Samples
CD4024BE	ACTIVE	PDIP	N	14	25	Green (RoHS & no Sb/Br)	CU NIPDAU	N / A for Pkg Type	-55 to 125	CD4024BE	Samples
CD4024BEE4	ACTIVE	PDIP	N	14	25	Green (RoHS & no Sb/Br)	CU NIPDAU	N / A for Pkg Type	-55 to 125	CD4024BE	Samples
CD4024BF	ACTIVE	CDIP	J	14	1	TBD	A42	N / A for Pkg Type	-55 to 125	CD4024BF	Samples
CD4024BF3A	ACTIVE	CDIP	J	14	1	TBD	A42	N / A for Pkg Type	-55 to 125	CD4024BF3A	Samples
CD4024BM	ACTIVE	SOIC	D	14	50	Green (RoHS & no Sb/Br)	CU NIPDAU	Level-1-260C-UNLIM	-55 to 125	CD4024BM	Samples
CD4024BM96	ACTIVE	SOIC	D	14	2500	Green (RoHS & no Sb/Br)	CU NIPDAU	Level-1-260C-UNLIM	-55 to 125	CD4024BM	Samples
CD4024BME4	ACTIVE	SOIC	D	14	50	Green (RoHS & no Sb/Br)	CU NIPDAU	Level-1-260C-UNLIM	-55 to 125	CD4024BM	Samples
CD4024BMG4	ACTIVE	SOIC	D	14	50	Green (RoHS & no Sb/Br)	CU NIPDAU	Level-1-260C-UNLIM	-55 to 125	CD4024BM	Samples
CD4024BMT	ACTIVE	SOIC	D	14	250	Green (RoHS & no Sb/Br)	CU NIPDAU	Level-1-260C-UNLIM	-55 to 125	CD4024BM	Samples

Orderable Device	Status (1)	Package Type	Package Drawing	Pins	Package Qty	Eco Plan (2)	Lead/Ball Finish (6)	MSL Peak Temp (3)	Op Temp (°C)	Device Marking (4/5)	Samples
CD4024BNSR	ACTIVE	SO	NS	14	2000	Green (RoHS & no Sb/Br)	CU NIPDAU	Level-1-260C-UNLIM	-55 to 125	CD4024B	Samples
CD4024BPW	ACTIVE	TSSOP	PW	14	90	Green (RoHS & no Sb/Br)	CU NIPDAU	Level-1-260C-UNLIM	-55 to 125	CM024B	Samples
CD4024BPWR	ACTIVE	TSSOP	PW	14	2000	Green (RoHS & no Sb/Br)	CU NIPDAU	Level-1-260C-UNLIM	-55 to 125	CM024B	Samples
CD4040BE	ACTIVE	PDIP	N	16	25	Green (RoHS & no Sb/Br)	CU NIPDAU	N / A for Pkg Type	-55 to 125	CD4040BE	Samples
CD4040BEE4	ACTIVE	PDIP	N	16	25	Green (RoHS & no Sb/Br)	CU NIPDAU	N / A for Pkg Type	-55 to 125	CD4040BE	Samples
CD4040BF	ACTIVE	CDIP	J	16	1	TBD	A42	N / A for Pkg Type	-55 to 125	CD4040BF	Samples
CD4040BF3A	ACTIVE	CDIP	J	16	1	TBD	A42	N / A for Pkg Type	-55 to 125	CD4040BF3A	Samples
CD4040BM	ACTIVE	SOIC	D	16	40	Green (RoHS & no Sb/Br)	CU NIPDAU	Level-1-260C-UNLIM	-55 to 125	CD4040BM	Samples
CD4040BM96	ACTIVE	SOIC	D	16	2500	Green (RoHS & no Sb/Br)	CU NIPDAU	Level-1-260C-UNLIM	-55 to 125	CD4040BM	Samples
CD4040BNSR	ACTIVE	SO	NS	16	2000	Green (RoHS & no Sb/Br)	CU NIPDAU	Level-1-260C-UNLIM	-55 to 125	CD4040B	Samples
CD4040BPW	ACTIVE	TSSOP	PW	16	90	Green (RoHS & no Sb/Br)	CU NIPDAU	Level-1-260C-UNLIM	-55 to 125	CM040B	Samples
CD4040BPWR	ACTIVE	TSSOP	PW	16	2000	Green (RoHS & no Sb/Br)	CU NIPDAU	Level-1-260C-UNLIM	-55 to 125	CM040B	Samples
CD4040BPWRG4	ACTIVE	TSSOP	PW	16	2000	Green (RoHS & no Sb/Br)	CU NIPDAU	Level-1-260C-UNLIM	-55 to 125	CM040B	Samples
JM38510/05653BEA	ACTIVE	CDIP	J	16	1	TBD	A42	N / A for Pkg Type	-55 to 125	JM38510/ 05653BEA	Samples
JM38510/05655BCA	ACTIVE	CDIP	J	14	1	TBD	A42	N / A for Pkg Type	-55 to 125	JM38510/ 05655BCA	Samples
M38510/05653BEA	ACTIVE	CDIP	J	16	1	TBD	A42	N / A for Pkg Type	-55 to 125	JM38510/ 05653BEA	Samples
M38510/05655BCA	ACTIVE	CDIP	J	14	1	TBD	A42	N / A for Pkg Type	-55 to 125	JM38510/ 05655BCA	Samples

(1) The marketing status values are defined as follows:
ACTIVE: Product device recommended for new designs.

LIFEBUY: TI has announced that the device will be discontinued, and a lifetime-buy period is in effect.

NRND: Not recommended for new designs. Device is in production to support existing customers, but TI does not recommend using this part in a new design.

PREVIEW: Device has been announced but is not in production. Samples may or may not be available.

OBSOLETE: TI has discontinued the production of the device.

⁽²⁾ **RoHS:** TI defines "RoHS" to mean semiconductor products that are compliant with the current EU RoHS requirements for all 10 RoHS substances, including the requirement that RoHS substance do not exceed 0.1% by weight in homogeneous materials. Where designed to be soldered at high temperatures, "RoHS" products are suitable for use in specified lead-free processes. TI may reference these types of products as "Pb-Free".

RoHS Exempt: TI defines "RoHS Exempt" to mean products that contain lead but are compliant with EU RoHS pursuant to a specific EU RoHS exemption.

Green: TI defines "Green" to mean the content of Chlorine (Cl) and Bromine (Br) based flame retardants meet JS709B low halogen requirements of ≤ 1000 ppm threshold. Antimony trioxide based flame retardants must also meet the ≤ 1000 ppm threshold requirement.

⁽³⁾ MSL, Peak Temp. - The Moisture Sensitivity Level rating according to the JEDEC industry standard classifications, and peak solder temperature.

⁽⁴⁾ There may be additional marking, which relates to the logo, the lot trace code information, or the environmental category on the device.

⁽⁵⁾ Multiple Device Markings will be inside parentheses. Only one Device Marking contained in parentheses and separated by a "~" will appear on a device. If a line is indented then it is a continuation of the previous line and the two combined represent the entire Device Marking for that device.

⁽⁶⁾ Lead/Ball Finish - Orderable Devices may have multiple material finish options. Finish options are separated by a vertical ruled line. Lead/Ball Finish values may wrap to two lines if the finish value exceeds the maximum column width.

Important Information and Disclaimer: The information provided on this page represents TI's knowledge and belief as of the date that it is provided. TI bases its knowledge and belief on information provided by third parties, and makes no representation or warranty as to the accuracy of such information. Efforts are underway to better integrate information from third parties. TI has taken and continues to take reasonable steps to provide representative and accurate information but may not have conducted destructive testing or chemical analysis on incoming materials and chemicals. TI and TI suppliers consider certain information to be proprietary, and thus CAS numbers and other limited information may not be available for release.

In no event shall TI's liability arising out of such information exceed the total purchase price of the TI part(s) at issue in this document sold by TI to Customer on an annual basis.

OTHER QUALIFIED VERSIONS OF CD4020B, CD4020B-MIL, CD4024B, CD4024B-MIL, CD4040B, CD4040B-MIL :

● Catalog: [CD4020B](#), [CD4024B](#), [CD4040B](#)

● Military: [CD4020B-MIL](#), [CD4024B-MIL](#), [CD4040B-MIL](#)

NOTE: Qualified Version Definitions:

● Catalog - TI's standard catalog product

- Military - QML certified for Military and Defense Applications

TAPE AND REEL INFORMATION

QUADRANT ASSIGNMENTS FOR PIN 1 ORIENTATION IN TAPE

*All dimensions are nominal

Device	Package Type	Package Drawing	Pins	SPQ	Reel Diameter (mm)	Reel Width W1 (mm)	A0 (mm)	B0 (mm)	K0 (mm)	P1 (mm)	W (mm)	Pin1 Quadrant
CD4020BNSR	SO	NS	16	2000	330.0	16.4	8.2	10.5	2.5	12.0	16.0	Q1
CD4020BPWR	TSSOP	PW	16	2000	330.0	12.4	6.9	5.6	1.6	8.0	12.0	Q1
CD4024BM96	SOIC	D	14	2500	330.0	16.4	6.5	9.0	2.1	8.0	16.0	Q1
CD4024BMT	SOIC	D	14	250	330.0	16.4	6.5	9.0	2.1	8.0	16.0	Q1
CD4024BNSR	SO	NS	14	2000	330.0	16.4	8.2	10.5	2.5	12.0	16.0	Q1
CD4024BPWR	TSSOP	PW	14	2000	330.0	12.4	6.9	5.6	1.6	8.0	12.0	Q1
CD4040BM96	SOIC	D	16	2500	330.0	16.4	6.5	10.3	2.1	8.0	16.0	Q1
CD4040BNSR	SO	NS	16	2000	330.0	16.4	8.1	10.4	2.5	12.0	16.0	Q1
CD4040BPWR	TSSOP	PW	16	2000	330.0	12.4	6.9	5.6	1.6	8.0	12.0	Q1

TAPE AND REEL BOX DIMENSIONS

*All dimensions are nominal

Device	Package Type	Package Drawing	Pins	SPQ	Length (mm)	Width (mm)	Height (mm)
CD4020BNSR	SO	NS	16	2000	367.0	367.0	38.0
CD4020BPWR	TSSOP	PW	16	2000	367.0	367.0	35.0
CD4024BM96	SOIC	D	14	2500	367.0	367.0	38.0
CD4024BMT	SOIC	D	14	250	210.0	185.0	35.0
CD4024BNSR	SO	NS	14	2000	367.0	367.0	38.0
CD4024BPWR	TSSOP	PW	14	2000	367.0	367.0	35.0
CD4040BM96	SOIC	D	16	2500	333.2	345.9	28.6
CD4040BNSR	SO	NS	16	2000	367.0	367.0	38.0
CD4040BPWR	TSSOP	PW	16	2000	367.0	367.0	35.0

J 14

GENERIC PACKAGE VIEW
CDIP - 5.08 mm max height
CERAMIC DUAL IN LINE PACKAGE



Images above are just a representation of the package family, actual package may vary.
Refer to the product data sheet for package details.

4040083-5/G

J0014A



PACKAGE OUTLINE

CDIP - 5.08 mm max height

CERAMIC DUAL IN LINE PACKAGE



4214771/A 05/2017

NOTES:

1. All controlling linear dimensions are in inches. Dimensions in brackets are in millimeters. Any dimension in brackets or parenthesis are for reference only. Dimensioning and tolerancing per ASME Y14.5M.
2. This drawing is subject to change without notice.
3. This package is hermetically sealed with a ceramic lid using glass frit.
4. Index point is provided on cap for terminal identification only and on press ceramic glass frit seal only.
5. Falls within MIL-STD-1835 and GDIP1-T14.

EXAMPLE BOARD LAYOUT

J0014A

CDIP - 5.08 mm max height

CERAMIC DUAL IN LINE PACKAGE



LAND PATTERN EXAMPLE
NON-SOLDER MASK DEFINED
SCALE: 5X

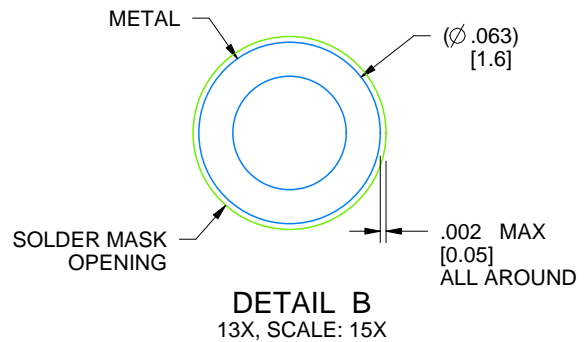
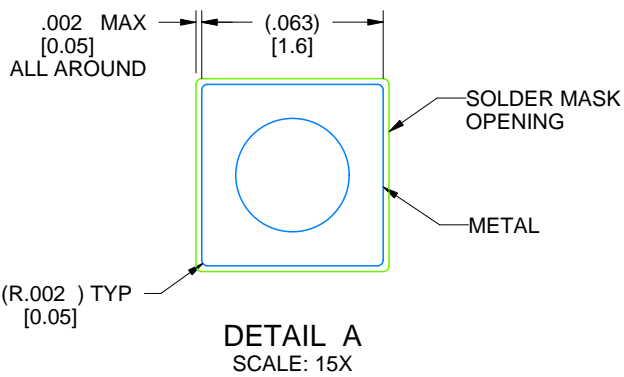



4214771/A 05/2017

D (R-PDSO-G14)

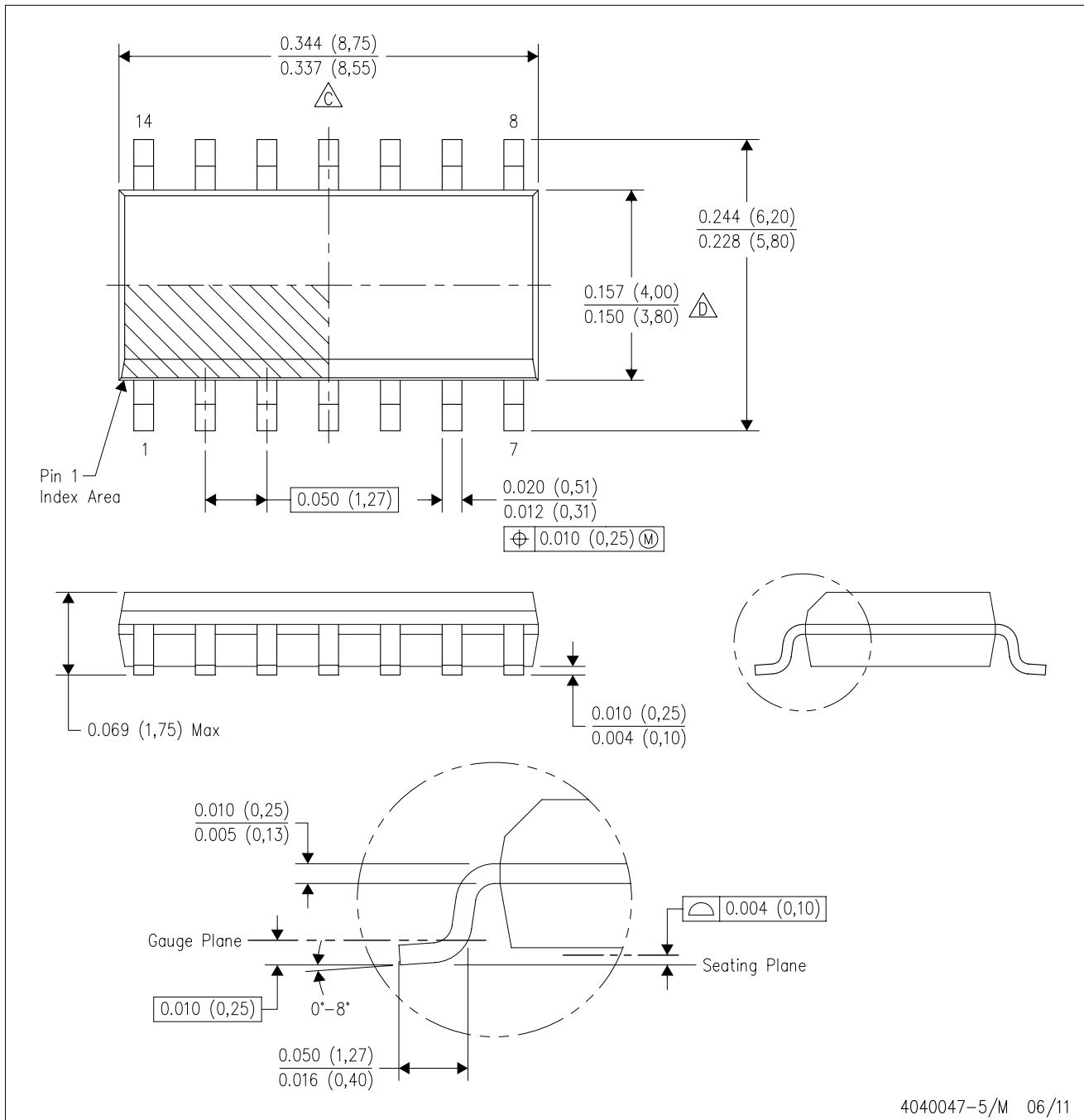
PLASTIC SMALL OUTLINE



4040047-5/M 06/11

- NOTES:
- A. All linear dimensions are in inches (millimeters).
 - B. This drawing is subject to change without notice.
 -  Body length does not include mold flash, protrusions, or gate burrs. Mold flash, protrusions, or gate burrs shall not exceed 0.006 (0,15) each side.
 -  Body width does not include interlead flash. Interlead flash shall not exceed 0.017 (0,43) each side.
 - E. Reference JEDEC MS-012 variation AB.

D (R-PDSO-G14)

PLASTIC SMALL OUTLINE



- NOTES:
- All linear dimensions are in millimeters.
 - This drawing is subject to change without notice.
 - Publication IPC-7351 is recommended for alternate designs.
 - Laser cutting apertures with trapezoidal walls and also rounding corners will offer better paste release. Customers should contact their board assembly site for stencil design recommendations. Refer to IPC-7525 for other stencil recommendations.
 - Customers should contact their board fabrication site for solder mask tolerances between and around signal pads.

PW (R-PDSO-G14)

PLASTIC SMALL OUTLINE

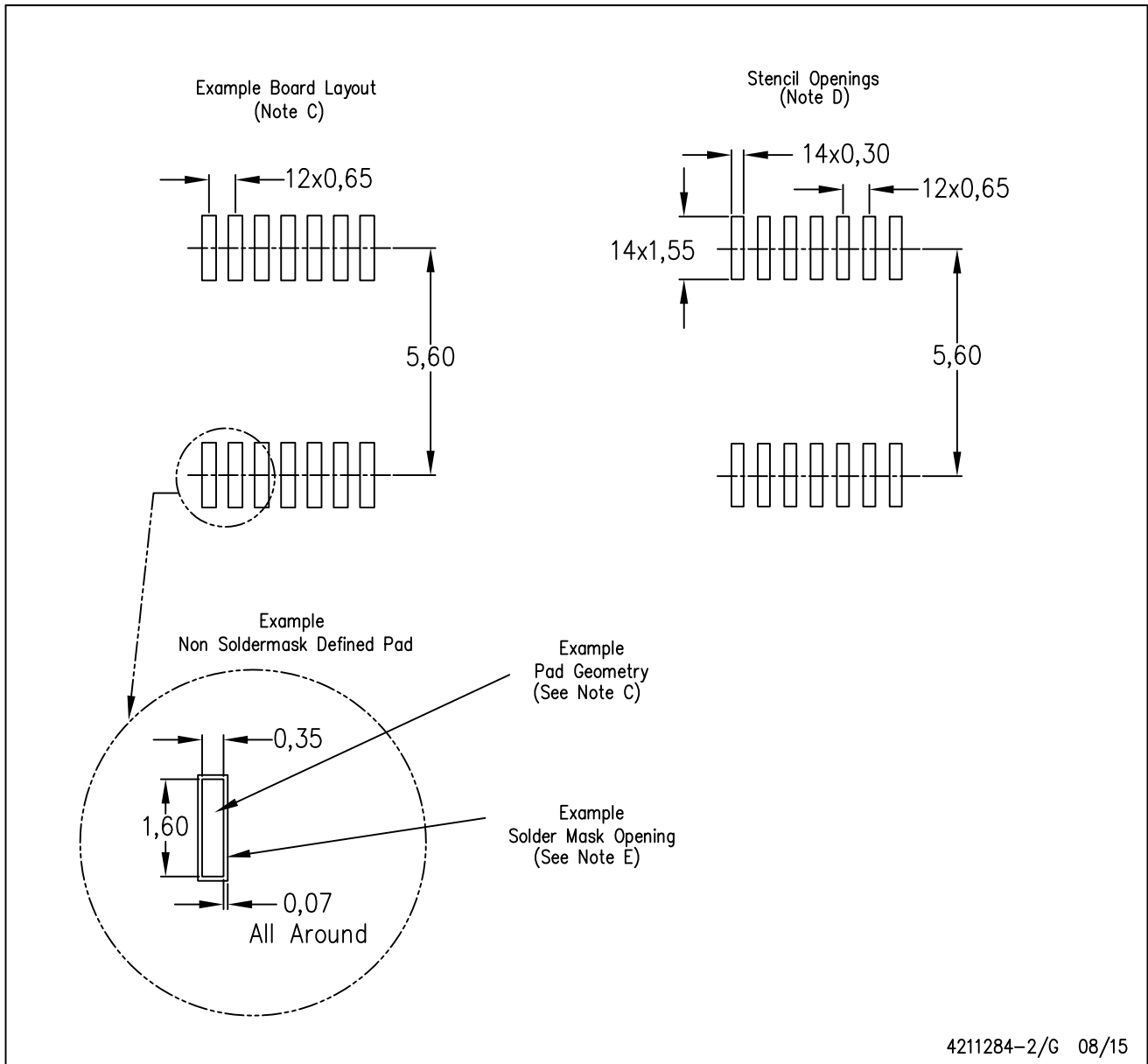

4211284-2/G 08/15

- NOTES:
- All linear dimensions are in millimeters.
 - This drawing is subject to change without notice.
 - Publication IPC-7351 is recommended for alternate designs.
 - Laser cutting apertures with trapezoidal walls and also rounding corners will offer better paste release. Customers should contact their board assembly site for stencil design recommendations. Refer to IPC-7525 for other stencil recommendations.
 - Customers should contact their board fabrication site for solder mask tolerances between and around signal pads.

N (R-PDIP-T**)

PLASTIC DUAL-IN-LINE PACKAGE

16 PINS SHOWN



- NOTES:
- A. All linear dimensions are in inches (millimeters).
 - B. This drawing is subject to change without notice.
 - C Falls within JEDEC MS-001, except 18 and 20 pin minimum body length (Dim A).
 - D The 20 pin end lead shoulder width is a vendor option, either half or full width.

4040049/E 12/2002

D (R-PDSO-G16)

PLASTIC SMALL OUTLINE



- NOTES:
- All linear dimensions are in millimeters.
 - This drawing is subject to change without notice.
 - Publication IPC-7351 is recommended for alternate designs.
 - Laser cutting apertures with trapezoidal walls and also rounding corners will offer better paste release. Customers should contact their board assembly site for stencil design recommendations. Refer to IPC-7525 for other stencil recommendations.
 - Customers should contact their board fabrication site for solder mask tolerances between and around signal pads.



4220204/A 02/2017

NOTES:

1. All linear dimensions are in millimeters. Any dimensions in parenthesis are for reference only. Dimensioning and tolerancing per ASME Y14.5M.
2. This drawing is subject to change without notice.
3. This dimension does not include mold flash, protrusions, or gate burrs. Mold flash, protrusions, or gate burrs shall not exceed 0.15 mm per side.
4. This dimension does not include interlead flash. Interlead flash shall not exceed 0.25 mm per side.
5. Reference JEDEC registration MO-153.

EXAMPLE BOARD LAYOUT

PW0016A

TSSOP - 1.2 mm max height

SMALL OUTLINE PACKAGE



LAND PATTERN EXAMPLE
EXPOSED METAL SHOWN
SCALE: 10X



4220204/A 02/2017

NOTES: (continued)

- 6. Publication IPC-7351 may have alternate designs.
- 7. Solder mask tolerances between and around signal pads can vary based on board fabrication site.

EXAMPLE STENCIL DESIGN

PW0016A

TSSOP - 1.2 mm max height

SMALL OUTLINE PACKAGE



SOLDER PASTE EXAMPLE
BASED ON 0.125 mm THICK STENCIL
SCALE: 10X

4220204/A 02/2017

NOTES: (continued)

8. Laser cutting apertures with trapezoidal walls and rounded corners may offer better paste release. IPC-7525 may have alternate design recommendations.
9. Board assembly site may have different recommendations for stencil design.

MECHANICAL DATA

NS (R-PDSO-G)**

PLASTIC SMALL-OUTLINE PACKAGE

14-PINS SHOWN



- NOTES:
- A. All linear dimensions are in millimeters.
 - B. This drawing is subject to change without notice.
 - C. Body dimensions do not include mold flash or protrusion, not to exceed 0,15.

IMPORTANT NOTICE AND DISCLAIMER

TI PROVIDES TECHNICAL AND RELIABILITY DATA (INCLUDING DATASHEETS), DESIGN RESOURCES (INCLUDING REFERENCE DESIGNS), APPLICATION OR OTHER DESIGN ADVICE, WEB TOOLS, SAFETY INFORMATION, AND OTHER RESOURCES "AS IS" AND WITH ALL FAULTS, AND DISCLAIMS ALL WARRANTIES, EXPRESS AND IMPLIED, INCLUDING WITHOUT LIMITATION ANY IMPLIED WARRANTIES OF MERCHANTABILITY, FITNESS FOR A PARTICULAR PURPOSE OR NON-INFRINGEMENT OF THIRD PARTY INTELLECTUAL PROPERTY RIGHTS.

These resources are intended for skilled developers designing with TI products. You are solely responsible for (1) selecting the appropriate TI products for your application, (2) designing, validating and testing your application, and (3) ensuring your application meets applicable standards, and any other safety, security, or other requirements. These resources are subject to change without notice. TI grants you permission to use these resources only for development of an application that uses the TI products described in the resource. Other reproduction and display of these resources is prohibited. No license is granted to any other TI intellectual property right or to any third party intellectual property right. TI disclaims responsibility for, and you will fully indemnify TI and its representatives against, any claims, damages, costs, losses, and liabilities arising out of your use of these resources.

TI's products are provided subject to TI's Terms of Sale (www.ti.com/legal/termsofsale.html) or other applicable terms available either on ti.com or provided in conjunction with such TI products. TI's provision of these resources does not expand or otherwise alter TI's applicable warranties or warranty disclaimers for TI products.

Mailing Address: Texas Instruments, Post Office Box 655303, Dallas, Texas 75265
Copyright © 2018, Texas Instruments Incorporated

Looking for pricing, stock, or lifecycle information?

Click below to explore more details on WIN SOURCE:

 [View CD4024BM96](#) on WIN SOURCE

 [Texas Instruments](#) Information

Optimize Your Supply Chain with WIN SOURCE Solutions

-  Global Sourcing Solution
-  Obsolete Management
-  Cost Control Management
-  Shortage Management
-  Alternative Solution
-  Excess Inventory Management