



THE DATASHEET OF CD4017BCM



CD4017BC • CD4022BC Decade Counter/Divider with 10 Decoded Outputs • Divide-by-8 Counter/Divider with 8 Decoded Outputs

General Description

The CD4017BC is a 5-stage divide-by-10 Johnson counter with 10 decoded outputs and a carry out bit.

The CD4022BC is a 4-stage divide-by-8 Johnson counter with 8 decoded outputs and a carry-out bit.

These counters are cleared to their zero count by a logical "1" on their reset line. These counters are advanced on the positive edge of the clock signal when the clock enable signal is in the logical "0" state.

The configuration of the CD4017BC and CD4022BC permits medium speed operation and assures a hazard free counting sequence. The 10/8 decoded outputs are normally in the logical "0" state and go to the logical "1" state only at their respective time slot. Each decoded output remains high for 1 full clock cycle. The carry-out signal completes a full cycle for every 10/8 clock input cycles and is used as a ripple carry signal to any succeeding stages.

Features

- Wide supply voltage range: 3.0V to 15V
- High noise immunity: 0.45 V_{DD} (typ.)
- Low power Fan out of 2 driving 74L
TTL compatibility: or 1 driving 74LS
- Medium speed operation: 5.0 MHz (typ.)
with 10V V_{DD}
- Low power: 10 μ W (typ.)
- Fully static operation

Applications

- Automotive
- Instrumentation
- Medical electronics
- Alarm systems
- Industrial electronics
- Remote metering

Ordering Code:

Order Number	Package Number	Package Description
CD4017BCM	M16A	16-Lead Small Outline Integrated Circuit (SOIC), JEDEC MS-012, 0.150" Narrow
CD4017BCN	N16E	16-Lead Plastic Dual-In-Line Package (PDIP), JEDEC MS-001, 0.300" Wide
CD4022BCM	M16A	16-Lead Small Outline Integrated Circuit (SOIC), JEDEC MS-012, 0.150" Narrow
CD4022BCN	N16E	16-Lead Plastic Dual-In-Line Package (PDIP), JEDEC MS-001, 0.300" Wide

Devices also available in Tape and Reel. Specify by appending the suffix letter "X" to the ordering code.

Connection Diagrams

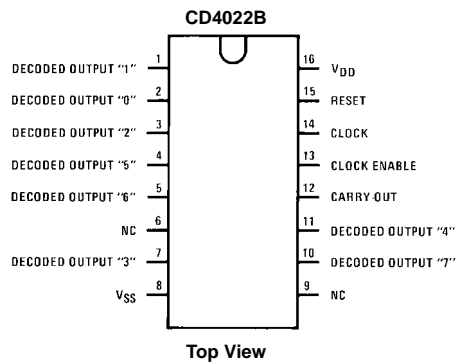
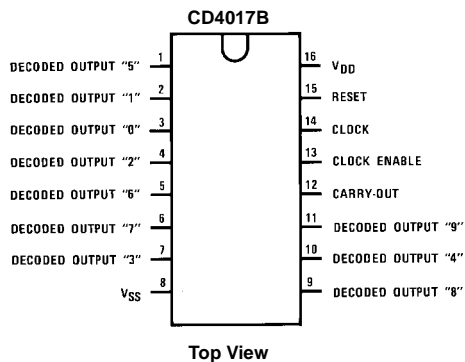

Absolute Maximum Ratings (Note 1)		Recommended Operating Conditions (Note 2)	
DC Supply Voltage (V_{DD})	-0.5 V_{DC} to +18 V_{DC}	DC Supply Voltage (V_{DD})	+3 V_{DC} to +15 V_{DC}
Input Voltage (V_{IN})	-0.5 V_{DC} to V_{DD} +0.5 V_{DC}	Input Voltage (V_{IN})	0 to V_{DD} V_{DC}
Storage Temperature (T_S)	-65°C to +150°C	Operating Temperature Range (T_A)	-55°C to +125°C
Power Dissipation (P_D)			
Dual-In-Line	700 mW		
Small Outline	500 mW		
Lead Temperature (T_L)			
(Soldering, 10 seconds)	260°C		

Note 1: "Absolute Maximum Ratings" are those values beyond which the safety of the device cannot be guaranteed, they are not meant to imply that the devices should be operated at these limits. The table of "Recommended Operating Conditions" and "Electrical Characteristics" provides conditions for actual device operation.

Note 2: $V_{SS} = 0V$ unless otherwise specified.

DC Electrical Characteristics (Note 2)

Symbol	Parameter	Conditions	-55°C		+25°C			+125°C		Units
			Min	Max	Min	Typ	Max	Min	Max	
I_{DD}	Quiescent Device Current	$V_{DD} = 5V$		5		0.3	5		150	μA
		$V_{DD} = 10V$		10		0.5	10		300	
		$V_{DD} = 15V$		20		1.0	20		600	
V_{OL}	LOW Level Output Voltage	$ I_{OL} < 1.0 \mu A$								V
		$V_{DD} = 5V$		0.05		0	0.05		0.05	
		$V_{DD} = 10V$		0.05		0	0.05		0.05	
		$V_{DD} = 15V$		0.05		0	0.05		0.05	
V_{OH}	HIGH Level Output Voltage	$ I_{OL} < 1.0 \mu A$								V
		$V_{DD} = 5V$	4.95		4.95	5		4.95		
		$V_{DD} = 10V$	9.95		9.95	10		9.95		
		$V_{DD} = 15V$	14.95		14.95	15		14.95		
V_{IL}	LOW Level Input Voltage	$ I_{OL} < 1.0 \mu A$								V
		$V_{DD} = 5V, V_O = 0.5V$ or $4.5V$		1.5			1.5		1.5	
		$V_{DD} = 10V, V_O = 1.0V$ or $9.0V$		3.0			3.0		3.0	
		$V_{DD} = 15V, V_O = 1.5V$ or $13.5V$		4.0			4.0		4.0	
V_{IH}	HIGH Level Input Voltage	$ I_{OL} < 1.0 \mu A$								V
		$V_{DD} = 5V, V_O = 0.5V$ or $4.5V$	3.5		3.5			3.5		
		$V_{DD} = 10V, V_O = 1.0V$ or $9.0V$	7.0		7.0			7.0		
		$V_{DD} = 15V, V_O = 1.5V$ or $13.5V$	11.0		11.0			11.0		
I_{OL}	LOW Level Output Current (Note 3)	$V_{DD} = 5V, V_O = 0.4V$	0.64		0.51	0.88		0.36		mA
		$V_{DD} = 10V, V_O = 0.5V$	1.6		1.3	2.25		0.9		
		$V_{DD} = 15V, V_O = 1.5V$	4.2		3.4	8.8		2.4		
I_{OH}	HIGH Level Output Current (Note 3)	$V_{DD} = 5V, V_O = 4.6V$	-0.25		-0.2	-0.36		-0.14		mA
		$V_{DD} = 10V, V_O = 9.5V$	-0.62		-0.5	-0.9		-0.35		
		$V_{DD} = 15V, V_O = 13.5V$	-1.8		-1.5	-3.5		-1.1		
I_{IN}	Input Current	$V_{DD} = 15V, V_{IN} = 0V$		-0.1		-10^{-5}	-0.1		-1.0	μA
		$V_{DD} = 15V, V_{IN} = 15V$		0.1		10^{-5}	0.1		1.0	

Note 3: I_{OL} and I_{OH} are tested one output at a time.

AC Electrical Characteristics (Note 4)

T_A = 25°C, C_L = 50 pF, R_L = 200k, t_{rCL} and t_{fCL} = 20 ns, unless otherwise specified

Symbol	Parameter	Conditions	Min	Typ	Max	Units
CLOCK OPERATION						
t _{PHL} , t _{PLH}	Propagation Delay Time Carry Out Line	V _{DD} = 5V		415	800	ns
		V _{DD} = 10V		160	320	
		V _{DD} = 15V		130	250	
	Carry Out Line	V _{DD} = 5V	C _L = 15 pF	240	480	ns
		V _{DD} = 10V		85	170	
		V _{DD} = 15V		70	140	
	Decode Out Lines	V _{DD} = 5V		500	1000	ns
		V _{DD} = 10V		200	400	
		V _{DD} = 15V		160	320	
t _{TLH} , t _{THL}	Transition Time Carry Out and Decode Out Lines	t _{TLH}	V _{DD} = 5V	200	360	ns
			V _{DD} = 10V	100	180	
		V _{DD} = 15V	80	130		
		t _{THL}	V _{DD} = 5V	100	200	ns
			V _{DD} = 10V	50	100	
			V _{DD} = 15V	40	80	
f _{CL}	Maximum Clock Frequency	V _{DD} = 5V	Measured with Respect to Carry Output Line	1.0	2	MHz
		V _{DD} = 10V		2.5	5	
		V _{DD} = 15V		3.0	6	
t _{WL} , t _{WH}	Minimum Clock Pulse Width	V _{DD} = 5V		125	250	ns
		V _{DD} = 10V		45	90	
		V _{DD} = 15V		35	70	
t _{rCL} , t _{fCL}	Clock Rise and Fall Time	V _{DD} = 5V			20	μs
		V _{DD} = 10V			15	
		V _{DD} = 15V			5	
t _{SU}	Minimum Clock Inhibit Data Setup Time	V _{DD} = 5V		120	240	ns
		V _{DD} = 10V		40	80	
		V _{DD} = 15V		32	65	
C _{IN}	Average Input Capacitance			5	7.5	pF

Note 4: AC Parameters are guaranteed by DC correlated testing.

AC Electrical Characteristics (Note 4)

T_A = 25°C, C_L = 50 pF, R_L = 200k, t_{rCL} and t_{fCL} = 20 ns, unless otherwise specified

Symbol	Parameter	Conditions	Min	Typ	Max	Units
RESET OPERATION						
t _{PHL} , t _{PLH}	Propagation Delay Time Carry Out Line	V _{DD} = 5V		415	800	ns
		V _{DD} = 10V		160	320	
		V _{DD} = 15V		130	250	
	Carry Out Line	V _{DD} = 5V	C _L = 15 pF	240	480	ns
		V _{DD} = 10V		85	170	
		V _{DD} = 15V		70	140	
	Decode Out Lines	V _{DD} = 5V		500	1000	ns
		V _{DD} = 10V		200	400	
		V _{DD} = 15V		160	320	
t _W	Minimum Reset Pulse Width	V _{DD} = 5V		200	400	ns
		V _{DD} = 10V		70	140	
		V _{DD} = 15V		55	110	
t _{REM}	Minimum Reset Removal Time	V _{DD} = 5V		75	150	ns
		V _{DD} = 10V		30	60	
		V _{DD} = 15V		25	50	

Timing Diagrams

CD4017B

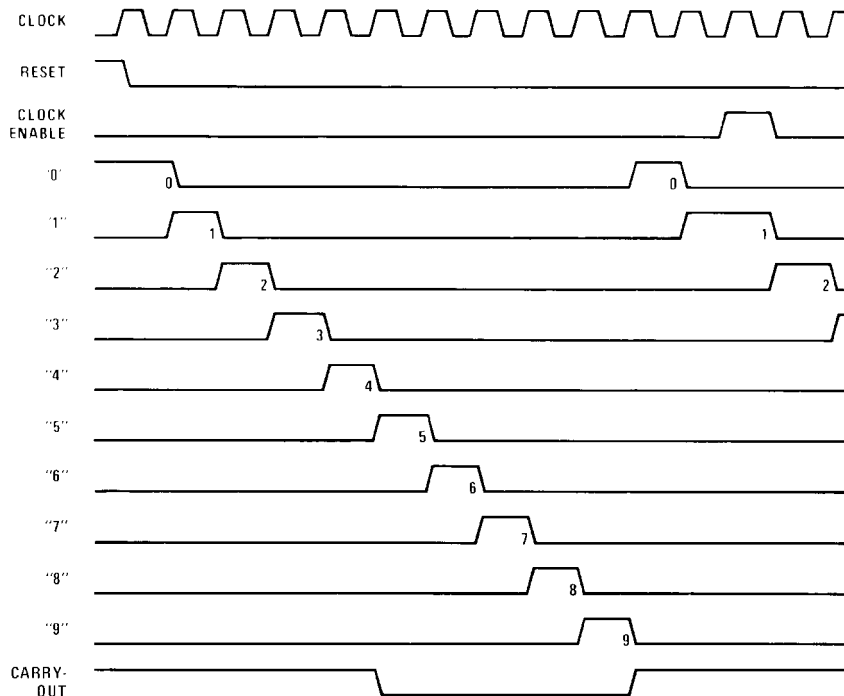

CD4022B

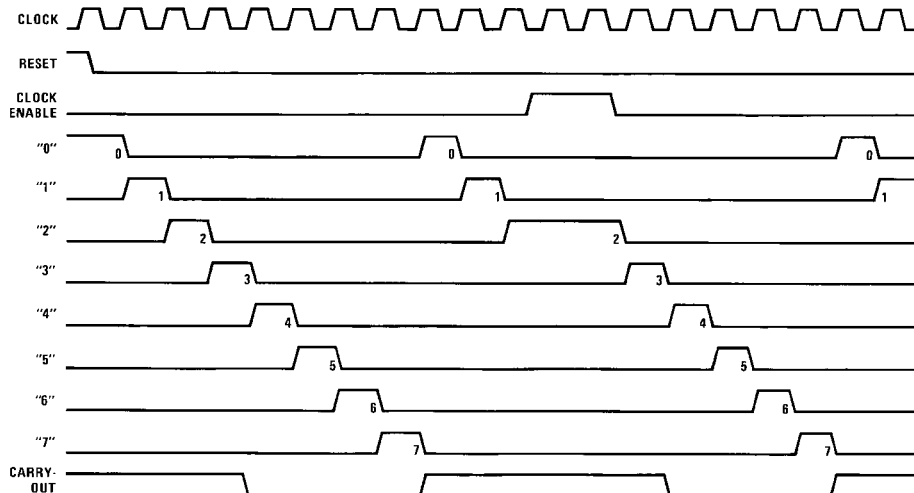

Physical Dimensions inches (millimeters) unless otherwise noted

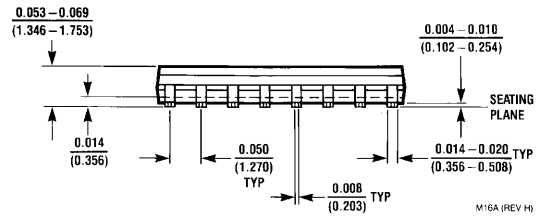
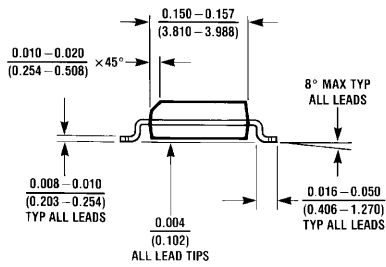
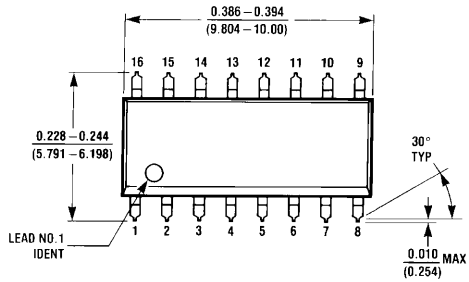

M16A (REV H)

16-Lead Small Outline Integrated Circuit (SOIC), JEDEC MS-012, 0.150" Narrow Package Number M16A

Physical Dimensions inches (millimeters) unless otherwise noted (Continued)

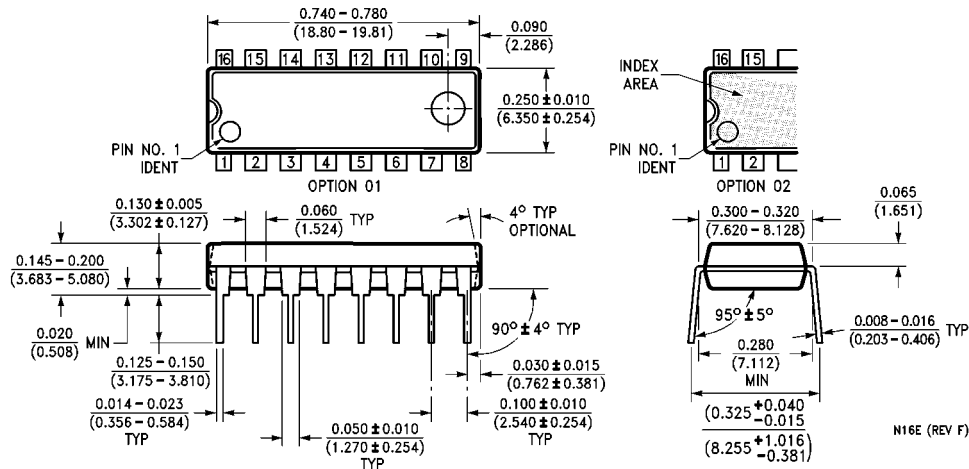

16-Lead Plastic Dual-In-Line Package (PDIP), JEDEC MS-001, 0.300" Wide Package Number N16E

Fairchild does not assume any responsibility for use of any circuitry described, no circuit patent licenses are implied and Fairchild reserves the right at any time without notice to change said circuitry and specifications.

LIFE SUPPORT POLICY

FAIRCHILD'S PRODUCTS ARE NOT AUTHORIZED FOR USE AS CRITICAL COMPONENTS IN LIFE SUPPORT DEVICES OR SYSTEMS WITHOUT THE EXPRESS WRITTEN APPROVAL OF THE PRESIDENT OF FAIRCHILD SEMICONDUCTOR CORPORATION. As used herein:

1. Life support devices or systems are devices or systems which, (a) are intended for surgical implant into the body, or (b) support or sustain life, and (c) whose failure to perform when properly used in accordance with instructions for use provided in the labeling, can be reasonably expected to result in a significant injury to the user.
2. A critical component in any component of a life support device or system whose failure to perform can be reasonably expected to cause the failure of the life support device or system, or to affect its safety or effectiveness.

www.fairchildsemi.com

Looking for pricing, stock, or lifecycle information?

Click below to explore more details on WIN SOURCE:

- ⊖ [View CD4017BCM on WIN SOURCE](#)
- ⊖ [Fairchild/ON Semiconductor Information](#)

Optimize Your Supply Chain with WIN SOURCE Solutions

- ✓ Global Sourcing Solution
- ✓ Obsolete Management
- ✓ Cost Control Management
- ✓ Shortage Management
- ✓ Alternative Solution
- ✓ Excess Inventory Management