



THE DATASHEET OF SLDB107S



**SINGLE-PHASE GLASS PASSIVATED
SILICON BRIDGE RECTIFIER**
VOLTAGE RANGE 50 to 1000 Volts CURRENT 1.0 Ampere

FEATURES

- * Good for automation insertion
- * Surge overload rating - 30 amperes peak
- * Ideal for printed circuit board
- * Reliable low cost construction utilizing molded
- * Glass passivated device
- * Polarity symbols molded on body

MECHANICAL DATA

- * Epoxy: Device has UL flammability classification 94V-0
- * Halogen-free
- * Mounting position: Any
- * Weight: 0.33 gram

MAXIMUM RATINGS AND ELECTRICAL CHARACTERISTICS

Ratings at 25 °C ambient temperature unless otherwise specified.
resistive or inductive load.

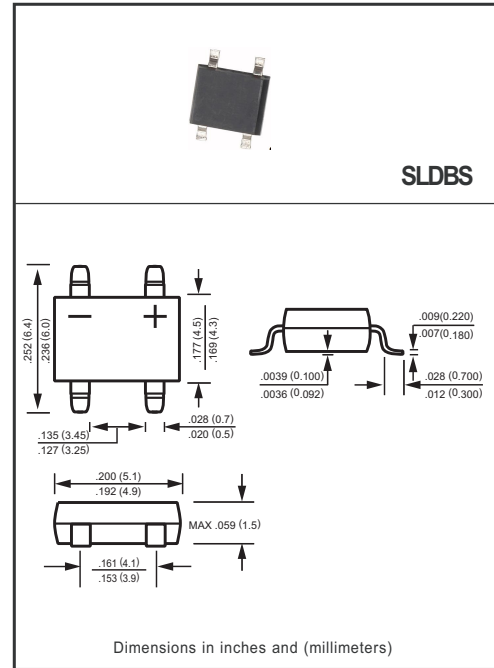

MAXIMUM RATINGS (At $T_A = 25^\circ\text{C}$ unless otherwise noted)

RATINGS	SYMBOL	SLDB101S	SLDB102S	SLDB103S	SLDB104S	SLDB105S	SLDB106S	SLDB107S	UNITS
Maximum Recurrent Peak Reverse Voltage	V_{RRM}	50	100	200	400	600	800	1000	Volts
Maximum RMS Bridge Input Voltage	V_{RMS}	35	70	140	280	420	560	700	Volts
Maximum DC Blocking Voltage	V_{DC}	50	100	200	400	600	800	1000	Volts
Maximum Average Forward Output Current at $T_L = 105^\circ\text{C}$	I_O	1.0							Amps
Peak Forward Surge Current 8.3 ms single half sine-wave superimposed on rated load (JEDEC method)	I_{FSM}	30							Amps
Typical Current Squared Time($t=8.3$ ms)	I^2t	3.735							A^2S
Typical Thermal Resistance (Note 2)	$R_{\theta JA}$	62.5							$^\circ\text{C}/\text{W}$
	$R_{\theta JL}$	25							
	$R_{\theta JC}$	8							
Typical Junction Capacitance (Note 3)	C_J	12							pF
Operating and Storage Temperature Range	T_J, T_{STG}	-55 to + 150							$^\circ\text{C}$

ELECTRICAL CHARACTERISTICS (At $T_A = 25^\circ\text{C}$ unless otherwise noted)

CHARACTERISTICS	SYMBOL	SLDB101S	SLDB102S	SLDB103S	SLDB104S	SLDB105S	SLDB106S	SLDB107S	UNITS
Maximum Forward Voltage Drop per Bridge Element at 1.0A DC	V_F	1.0							Volts
Maximum Reverse Current at Rated DC Blocking Voltage per element	@ $T_A = 25^\circ\text{C}$	1.0							μAmps
	@ $T_A = 125^\circ\text{C}$	0.05							mAmps

Note: 1. " RoHS compliant".
2. Thermal Resistance: Mounted on PCB.
3. Measured at 1 MHz and applied reverse voltage of 4.0 volts.

RATING AND CHARACTERISTICS CURVES (SLDB101S THRU SLDB107S)

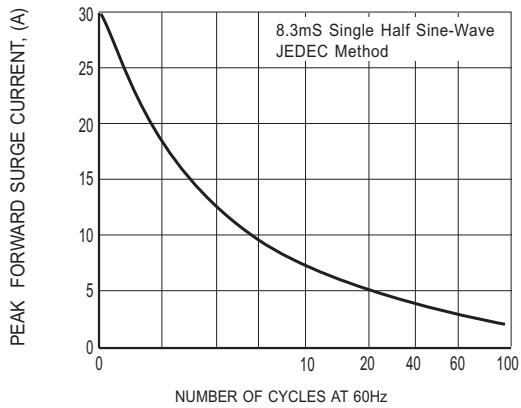

FIG. 1 - MAXIMUM NON-REPETITIVE FORWARD SURGE CURRENT

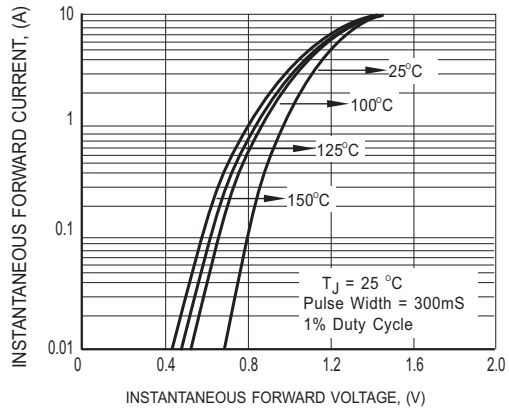

FIG. 2 MAXIMUM INSTANTANEOUS FORWARD CHARACTERISTICS

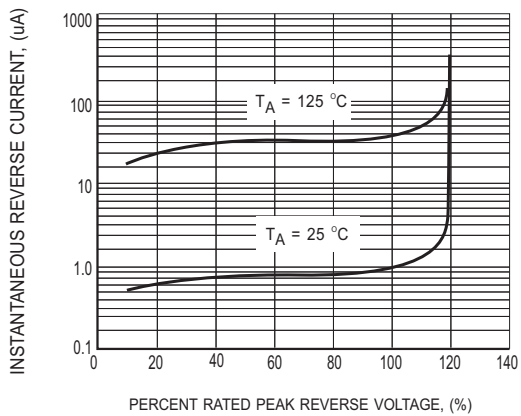

FIG. 3 MAXIMUM REVERSE CHARACTERISTICS

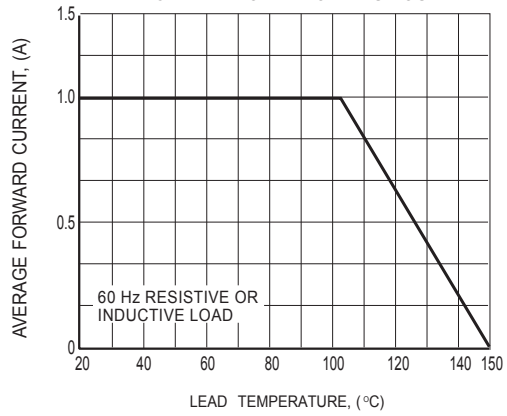
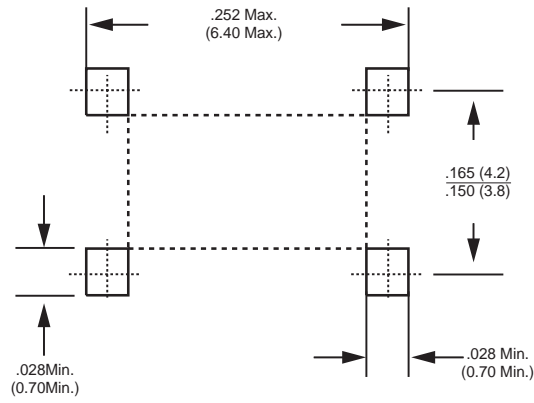

FIG. 4 TYPICAL FORWARD CURRENT DERATING CURVE

Mounting Pad Layout



Dimensions in inches and (millimeters)

REEL TAPING SPECIFICATIONS FOR SURFACE MOUNT DEVICES-SLDBS

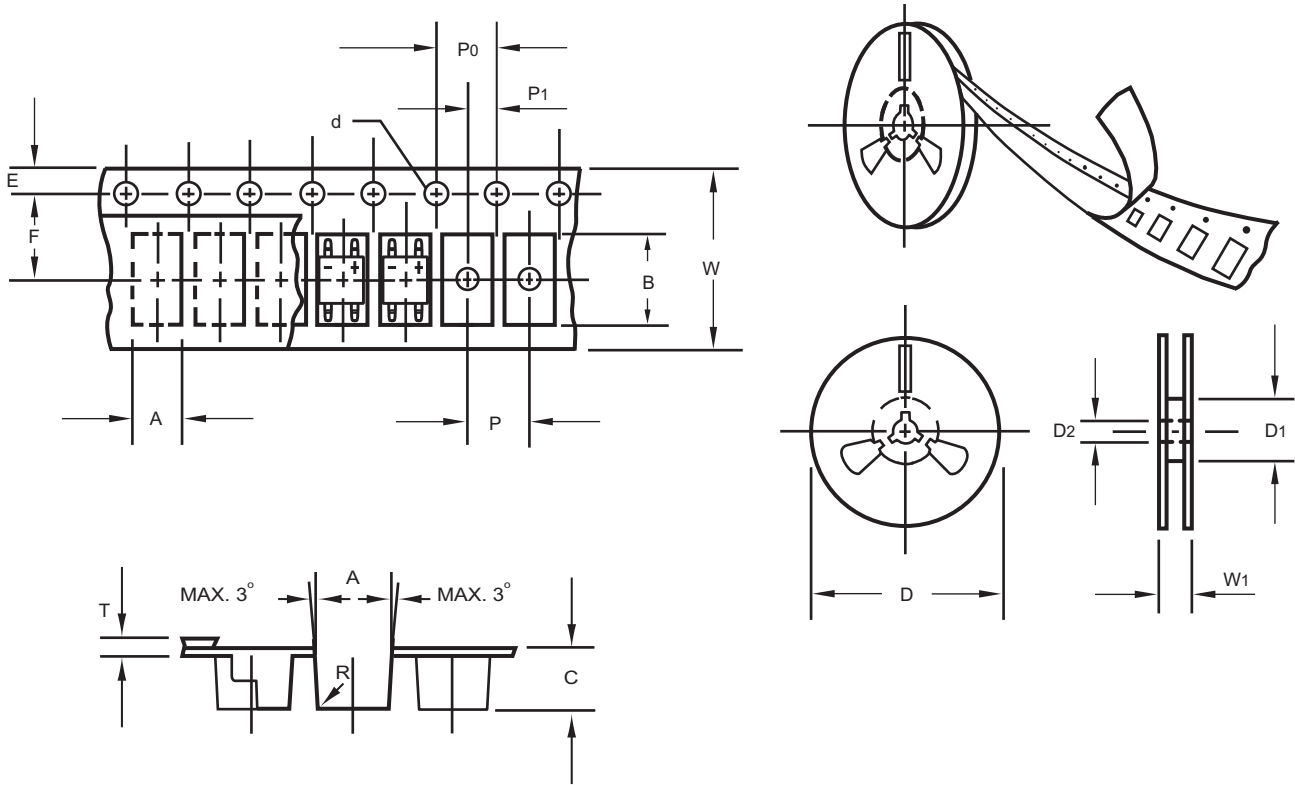
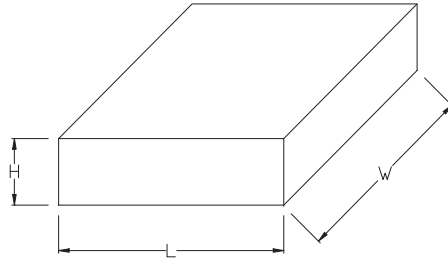

Fig.: Configuration of SLDBS TAPING

ITEM	SYMBOL	SLDBS mm(inch)
Carrier width	A	6.0 ± 0.1 (0.236 ± 0.004)
Carrier length	B	8.30 ± 0.1 (0.327 ± 0.004)
Carrier depth	C	2.5 ± 0.1 (0.098 ± 0.004)
Sprocket hole	d	1.5 ± 0.1 (0.059 ± 0.004)
Reel outside diameter	D	330 ± 2.0 (13.0 ± 0.079)
Reel inner diameter	D1	50 Min.
Feed hole diameter	D2	13 ± 0.5 (0.512 ± 0.020)
Strocket hole position	E	1.5 ± 0.1 (0.059 ± 0.004)
Punch hole position	F	7.65 ± 0.05 (0.301 ± 0.002)
Punch hole pitch	P	8.0 ± 0.1 (0.315 ± 0.004)
Sprocket hole pitch	P0	4.0 ± 0.1 (0.157 ± 0.004)
Embossment center	P1	4.0 ± 0.1 (0.157 ± 0.004)
Totall tape thickness	T	0.6 Max.
Tape width	W	16.0 ± 0.2 (0.630 ± 0.008)
Reel width	W1	24.0 ± 2.0 (0.945 ± 0.079)

Note: 1.Devices are packed in accordance with EIA standard RS-481-A and specification given above.
2.13 inch (5000 ct.) diameter reels.

1. BOX



Packing Code	L (mm)	W (mm)	H (mm)
-T/W	338	338	40

2. REEL

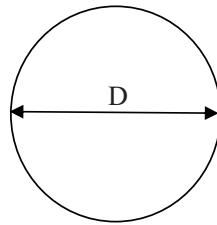

Packing Code	D (mm)
-T/W	330

3. CARTON

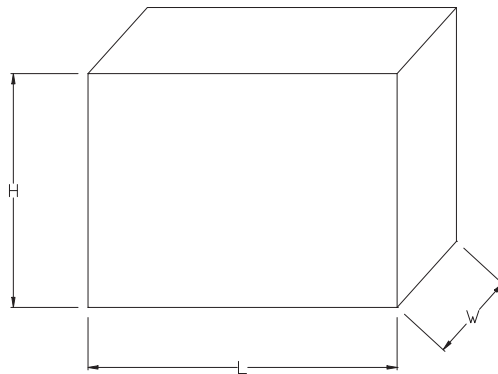

Packing Code	L (mm)	W (mm)	H (mm)
-T/W	360	355	360

PACKAGING OF DIODE AND BRIDGE RECTIFIERS

REEL PACK

PACKAGE	PACKING CODE	EA PER REEL	EA PER INNER BOX	COMPONENT SPACE (mm)	TAPE SPACE (mm)	REEL DIA (mm)	CARTON SIZE (mm)	EA PER CARTON	GROSS WEIGHT(Kg)
SLDBS	-T/W	5,000	10,000	---	---	330	360*355*360	80,000	16.18



DISCLAIMER NOTICE

Rectron Inc reserves the right to make changes without notice to any product specification herein, to make corrections, modifications, enhancements or other changes. Rectron Inc or anyone on its behalf assumes no responsibility or liability for any errors or inaccuracies. Data sheet specifications and its information contained are intended to provide a product description only. "Typical" parameters which may be included on RECTRON data sheets and/ or specifications can and do vary in different applications and actual performance may vary over time. Rectron Inc does not assume any liability arising out of the application or use of any product or circuit.

Rectron products are not designed, intended or authorized for use in medical, life-saving implant or other applications intended for life-sustaining or other related applications where a failure or malfunction of component or circuitry may directly or indirectly cause injury or threaten a life without expressed written approval of Rectron Inc. Customers using or selling Rectron components for use in such applications do so at their own risk and shall agree to fully indemnify Rectron Inc and its subsidiaries harmless against all claims, damages and expenditures.

Looking for pricing, stock, or lifecycle information?

Click below to explore more details on WIN SOURCE:

-  [View SLDB107S on WIN SOURCE](#)
-  [Rectron USA Information](#)

Optimize Your Supply Chain with WIN SOURCE Solutions

-  Global Sourcing Solution
-  Obsolete Management
-  Cost Control Management
-  Shortage Management
-  Alternative Solution
-  Excess Inventory Management