



**THE DATASHEET OF  
LCGHF5A10LC**



# LC Series Small Size Precision Snap-acting Switches



## Features/Benefits

- Compact design
- Long life and high electrical capacity
- Quick connect, wire lead or PC mounting
- Wide variety of actuator styles

## Typical Applications

- Motorized equipment
- Sump pump
- Thermostatic controls

UL61058-1



## Specifications

CONTACT RATING: From low level\* to 10.1 AMPS @ 250 V AC.  
 ELECTRICAL LIFE: 100,000 cycles  
 INSULATION RESISTANCE: 1,000 M Ω min.  
 DIELECTRIC STRENGTH: 1,000 Vrms min. @ sea level.  
 OPERATING TEMPERATURE: -17°F to 185°F (-25°C to 85°C).  
 OPERATING FORCE: From 142 to 170 grams at actuator button.  
 Forces are less at free end of lever actuators; (see OPERATING FORCE and ACTUATOR option sections).  
 MOUNTING: 2-56 screws, torque 2.3 in/lbs max.

\* Low Level—conditions where no arcing occurs during switching, i.e., 0.4 VA max. @ 20 V AC or DC max.

**NOTE:** Specifications and materials listed above are for switches with standard options. For information on specific and custom switches, consult Customer Service center.

## Materials

SWITCH HOUSING: Thermoplastic polyester or high temperature thermoplastic (PTS) (UL 94V-0).  
 ACTUATOR BUTTON: Thermoplastic polyester (UL 94V-0).  
 SPRING: Copper alloy.  
 PIVOT: Copper alloy.  
 MOVABLE CONTACTS: Fine silver for ratings greater than 1 AMP @ 125 V AC. Fine silver with 24K gold plate for 1 AMP @ 125 V AC or less.  
 STATIONARY CONTACTS: Fine silver welded on copper alloy for ratings greater than 1 AMP @ 125 V AC. Gold alloy welded on copper alloy for ratings less than 1 AMP @ 125 V AC.  
 TERMINALS: Copper alloy.  
 TERMINAL SEAL: Epoxy.

Snap-acting

## Build-A-Switch

To order, simply select desired option from each category and place in the appropriate box. For additional options not shown in catalog, consult Customer Service Center.

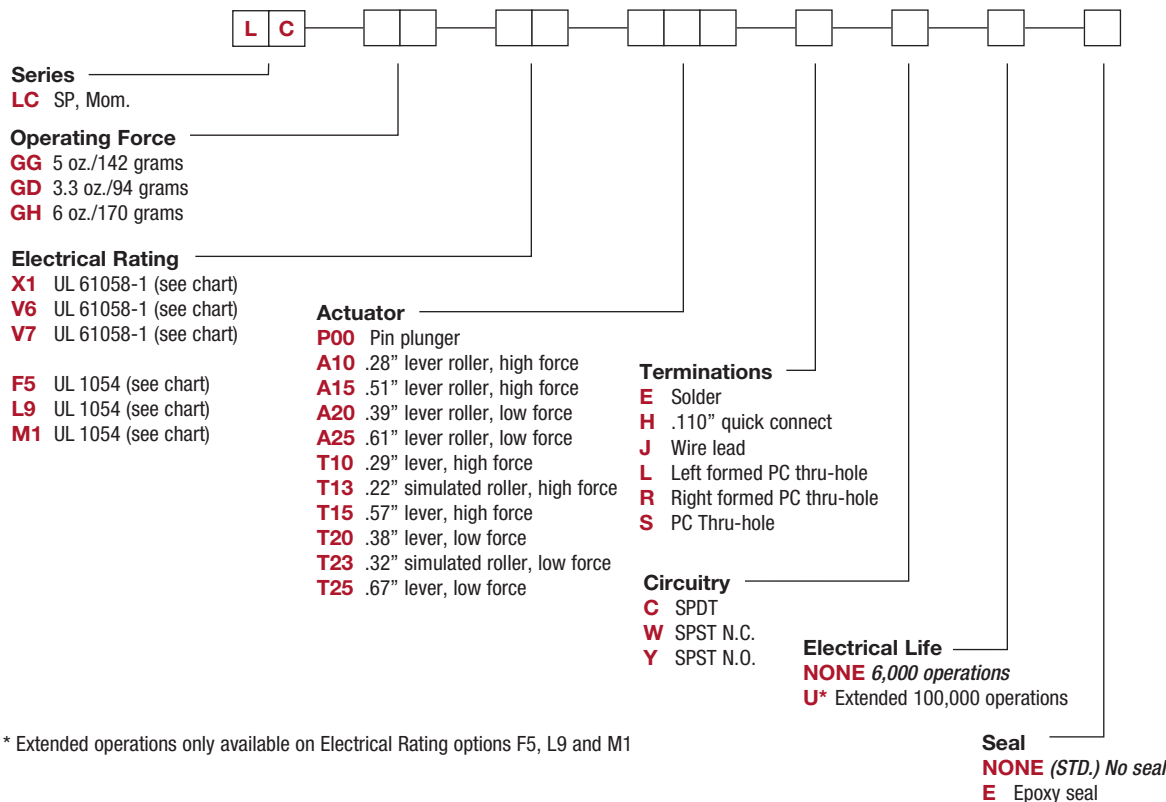

\* Extended operations only available on Electrical Rating options F5, L9 and M1



Dimensions are shown: Inch (mm)  
 Specifications and dimensions subject to change

# LC Series Small Size Precision Snap-acting Switches

## SERIES

**LC** SMALL SIZE PRECISION SNAP-ACTING SWITCHES  
SP MOMENTARY

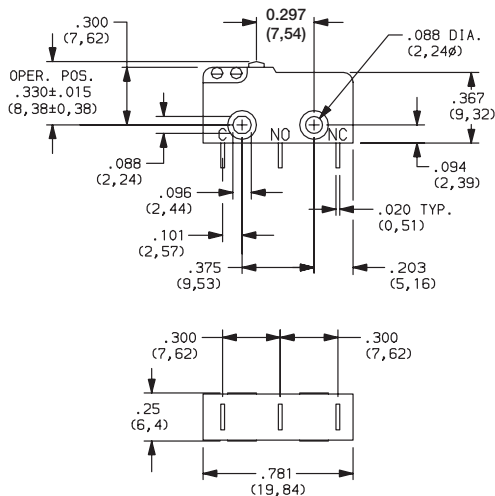

## OPERATING FORCE

OPTION CODE	BASIC SWITCH OPERATING FORCES (OZ./GRAMS)
<b>GG</b>	5 142
<b>GD</b>	3.3 94
<b>GH</b>	6 170

NOTE: Operating force varies with actuator option, see ACTUATOR option section.

## ELECTRICAL RATING

UL 61058-1		CONTACT MATERIAL		RoHS COMPLIANT*	RoHS COMPATIBLE*
OPTION CODE	ELECTRICAL RATING	MOVABLE CONTACT	STATIONARY CONTACT		
<b>X1</b>	1A GP, 250 Vac, 50/60 Hz, 25E3, T85 1RA, 30 Vdc, 1E4, T85	Fine silver with 24K gold plate	Fine silver with 24K gold plate on copper base alloy	Yes	Yes
<b>V6</b>	5(2)A RM, 250 Vac, 50/60 Hz, 1E4, T85 5A GP, 250 Vac, 50/60 Hz, 1E4, T85 5RA, 30 Vdc, 1E4, T85 1/3 HP, 125/250 Vac, 50/60 Hz, 1E4, T85	Fine silver	Fine silver welded on copper base alloy	Yes	Yes
<b>V7</b>	10(2)A RM, 250 Vac, 50/60 Hz, 1E4, T85 10A GP, 250 Vac, 50/60 Hz, 1E4, T85 10RA, 30 Vdc, 1E4, T85 1/3 HP, 125/250 Vac, 50/60 Hz, 1E4, T85	Fine silver	Fine silver welded on copper base alloy	Yes	Yes

UL 1054		CONTACT MATERIAL		RoHS COMPLIANT*	RoHS COMPATIBLE*
OPTION CODE	ELECTRICAL RATING	MOVABLE CONTACT	STATIONARY CONTACT		
<b>F5</b>	1A, 125 V AC, 30 VDC 100,000 cycles ("U" option)	Fine silver with 24K gold plate	Fine silver with 24K gold plate on copper base alloy	Yes	Yes
<b>L9</b>	5A, 1/3 HP @ 125 and 250 V AC 100,000 cycles ("U" option)	Fine silver	Fine silver welded on copper base alloy	Yes	Yes
<b>M1</b>	10.1A, 1/3 HP @ 125 and 250 V AC 100,000 cycles ("U" option)	Fine silver	Fine silver welded on copper base alloy	Yes	Yes



\* Note: See Technical Data section of this catalog for RoHS compliant and compatible definition and specifications. Consult Customer Service Center for availability and delivery of nonstandard ratings.

\*Low Level = conditions where no arcing occurs during switching, i.e., 0.4 VA max. @ 20 V AC or DC max.



Dimensions are shown: Inches (mm)

Specifications and dimensions subject to change



Snap-acting

# LC Series Small Size Precision Snap-acting Switches

## ACTUATOR

OPTION CODE	FIG.	DIM. A	DIM. B	DIM. C
<b>P00</b>	1	0.297 (7,6)	.330 ± .015 (8,38 ± 0,38)	—
<b>A10</b>	7	0.28 (7,1)	.570 ± .070 (14,48 ± 1,78)	.19 dia. (4,80)
<b>A25</b>	2	0.61 (15,5)	.570 ± .175 (14,22 ± 4,45)	.19 dia. (4,80)
<b>T10</b>	3	0.29 (7,4)	.340 ± .070 (8,64 ± 1,78)	—
<b>T13</b>	5	0.220 (5,3)	.455 ± .065 (11,56 ± 1,65)	—
<b>T20</b>	4	0.39 (9,9)	.340 ± .140 (8,64 ± 3,56)	—
<b>T23</b>	6	0.32 (8,1)	.455 ± .125 (11,56 ± 3,18)	—
<b>T25</b>	4	0.67 (17,0)	.340 ± .091 (8,64 ± 4,70)	—
<b>A15</b>	7	0.51 (13,0)	.560 ± .090 (14,22 ± 2,29)	.19 dia. (4,80)
<b>A20</b>	2	0.38 (9,7)	.560 ± .135 (14,22 ± 2,29)	.19 dia. (4,80)
<b>T15</b>	3	0.57 (14,51)	.340 ± .100 (8,64 ± 2,54)	—

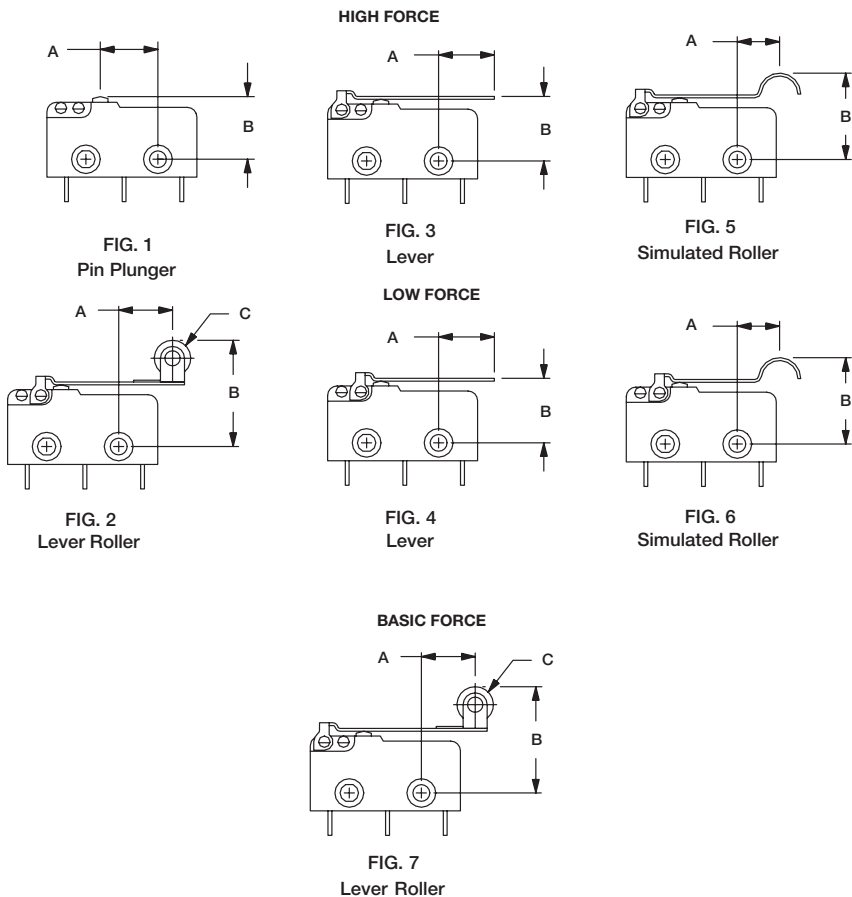

## SWITCH CHARACTERISTICS

OPTION CODE	MAXIMUM OPERATING FORCE (OZ./GRAMS)			MINIMUM RELEASE FORCE (OZ./GRAMS)			MAXIMUM DIFFERENTIAL TRAVEL	MAXIMUM PRETRAVEL	MINIMUM OVERTRAVEL
	GG	GD	GH	GG	GD	GH	ALL FORCES	ALL FORCES	ALL FORCES
A10	1.69 48	1 28	2.0 57	.21 6	.11 3	.42 12	.034 (0,86)	.140 (3,56)	.029 (0,74)
A15	1.3 37	.68 19	1.6 44	.16 4.5	.07 2	.32 9	.044 (1,12)	.180 (4,57)	.037 (0,94)
A20	0.9 26	.52 15	1.1 31	.11 3	.05 15	.21 6	.067 (1,70)	.272 (6,91)	.053 (1,53)
A25	.70 20	.42 12	.85 24	.07 2	.04 1	.16 4.5	.086 (2,18)	.351 (8,92)	.068 (1,73)
P00	5 142	3.3 95	6 170	1 28	.05 14	2.0 57	.004 (0,10)	.030 (0,76)	.010 (0,25)
T10	1.7 48	1 28	2.1 60	.21 6	.10 3	.39 11	.035 (0,90)	.140 (3,56)	.029 (0,74)
T13	1.8 52	1.2 34	2.2 62	.21 6	.03 1	.42 12	.032 (0,81)	.130 (3,30)	.026 (0,66)
T20	0.9 26	.52 15	1.1 30	.10 3	.03 1	.21 6	.067 (1,70)	.276 (7,01)	.053 (1,35)
T23	1.0 28	.52 15	1.2 34	.10 3	.03 1	.21 6	.062 (1,57)	.252 (6,40)	.049 (1,24)
T25	0.7 19	.05 14	0.8 24	.07 2	.03 1	.14 4	.090 (2,29)	.372 (9,45)	.072 (1,83)
T15	1.2 35	1.3 39	1.5 42	0.14 4	.21 6	.28 81	.047 (1,19)	.190 (4,83)	.040 (1,02)

NOTE: For basic switch operating forces, see page J-32.

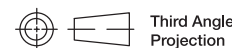

Third Angle Projection

Dimensions are shown: Inch (mm)

Specifications and dimensions subject to change

# LC Series Small Size Precision Snap-acting Switches

## TERMINATIONS

### E SOLDER

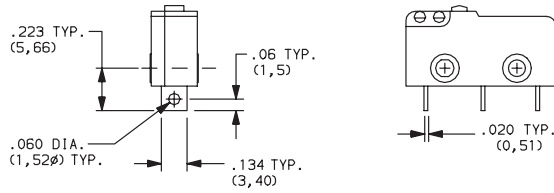

### H .110" QUICK CONNECT

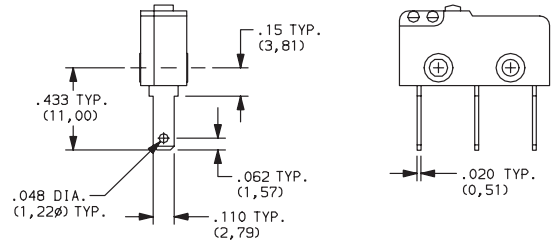

NOTE: Use Amp Quick Connect Part No. 640932-1.

### J WIRE LEAD

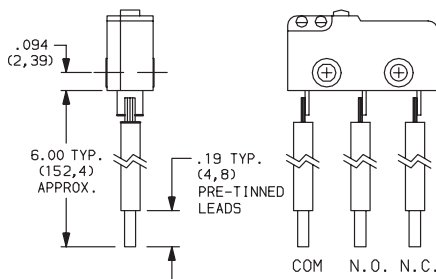

RATING	WIRE SIZE
1 AMP	22 AWG
5 AMPS	20 AWG
10.1 AMPS	18 AWG

TERMINAL	WIRE COLOR
COMMON	BLACK
NORMALLY OPEN	WHITE
NORMALLY CLOSED	RED

### L LEFT FORMED PC THRU-HOLE

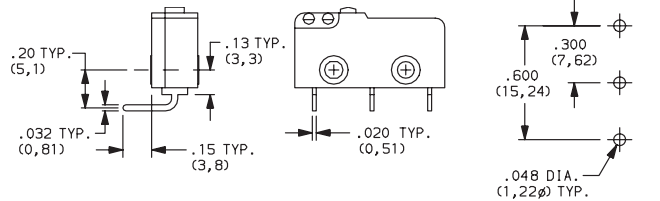

### R RIGHT FORMED PC THRU-HOLE

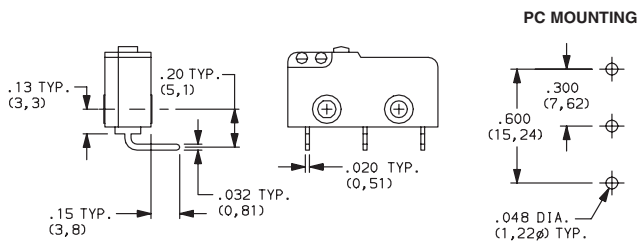

### S PC THRU-HOLE

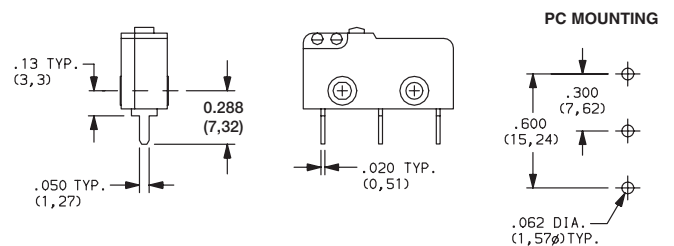

## CIRCUITRY

**C** SPDT (Single Pole, Double Throw)

**W** SPST N.C. (Single Pole, Single Throw, Normally Closed)

**Y** SPST N.O. (Single Pole, Single Throw, Normally Open)

## ELECTRICAL LIFE

**NONE** 6,000 OPERATIONS

**U** EXTENDED 100,000 OPERATIONS

## SEAL

**NONE** NO SEAL

**E** EPOXY SEAL

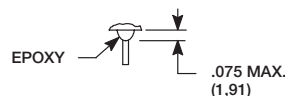

Third Angle Projection

Dimensions are shown: mm  
Specifications and dimensions subject to change

**C&K**

## Looking for pricing, stock, or lifecycle information?

Click below to explore more details on WIN SOURCE:

- ⊖ [View LCGHF5A10LC on WIN SOURCE](#)
- ⊖ [C&K Components Information](#)

## Optimize Your Supply Chain with WIN SOURCE Solutions

- ✓ Global Sourcing Solution
- ✓ Obsolete Management
- ✓ Cost Control Management
- ✓ Shortage Management
- ✓ Alternative Solution
- ✓ Excess Inventory Management