



**THE DATASHEET OF
ISL24021IRT065Z-T13**



ISL24021

1A Rail-to-Rail Input-Output Operational Amplifier

FN6637
Rev 1.00
October 18, 2011

The ISL24021 is a high output current, high voltage, rail-to-rail voltage feedback amplifier. The ISL24021 is capable of $\pm 1A$ peak output short circuit current. The amplifier exhibits beyond the rail input capability, rail-to-rail output capability and is unity gain stable.

The operating supply voltage range is from 4.5V to 19V maximum and the ISL24021 can be configured for single or dual supply operation. The ISL24021 has the ability to quickly source and sink large peak currents up to $\pm 1A$ and to drive large continuous currents of $\pm 300mA$.

The ISL24021 features fast slewing and settling times. Also, the device provides common mode input capability beyond the supply rails, and rail-to-rail output capability. This enables the amplifier to offer maximum dynamic range at any supply voltage. These features make the ISL24021 an ideal solution as a V_{COM} driver in TFT-LCD panel applications. Other applications may include battery power and portable devices, and especially where low power consumption is important.

The ISL24021 is available in a 8 Ld 3mmx3mm TDFN package featuring a standard operational amplifier pinout with a lead pitch of 0.65mm. The device utilizes a thermally enhanced package and has a built-in thermal protection circuit. It is specified for operation over an ambient temperature range of $-40^{\circ}C$ to $+85^{\circ}C$.

Pin Configuration

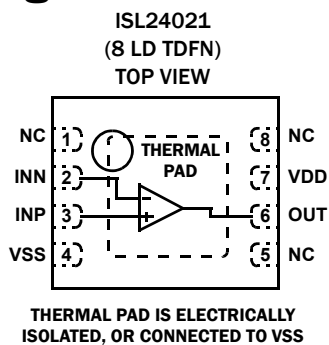

Features

- $\pm 1A$ Output Short Circuit Current
- 4.5V to 19V Maximum Supply Voltage Range
- 2.0mA Supply Current
- 18V/ μs Slew Rate
- 25MHz -3dB Bandwidth
- $\pm 300mA$ Continuous Output Current
- Unity-Gain Stable
- Beyond the Rails Input Capability
- Rail-to-Rail Output Swing
- Built-in Thermal Protection
- $-40^{\circ}C$ to $+85^{\circ}C$ Ambient Temperature Range
- Pb-Free (RoHS Compliant)

Applications

- TFT-LCD Panels
- V_{COM} Driver
- Video Processing
- Audio Processing
- Active Filters
- Test Equipment
- Battery-Powered Applications
- Portable Equipment

Ordering Information

PART NUMBER (Notes 1, 2, 3)	LEAD PITCH (mm)	PART MARKING	PACKAGE Tape & Reel (Pb-Free)	PKG. DWG. #
ISL24021IRT065Z-T7A	0.65	P021	8 Ld TDFN	L8.3x3K
ISL24021IRT065Z-T13	0.65	P021	8 Ld TDFN	L8.3x3K

NOTES:

1. Please refer to [TB347](#) for details on reel specifications.
2. These Intersil Pb-free plastic packaged products employ special Pb-free material sets, molding compounds/die attach materials, and 100% matte tin plate plus anneal (e3 termination finish, which is RoHS compliant and compatible with both SnPb and Pb-free soldering operations). Intersil Pb-free products are MSL classified at Pb-free peak reflow temperatures that meet or exceed the Pb-free requirements of IPC/JEDEC J STD-020.
3. For Moisture Sensitivity Level (MSL), please see device information page for [ISL24021](#). For more information on MSL please see techbrief [TB363](#).

Absolute Maximum Ratings ($T_A = +25^\circ\text{C}$)

Supply Voltage Range ($V_{DD} - V_{SS}$)	19.8V
Input Voltage Range (INN, INP)	$V_{SS} - 0.5V, V_{DD} + 0.5V$
Input Differential Voltage (INP - INN)	$(V_{DD} + 0.5V) - (V_{SS} - 0.5V)$
ESD Rating	
Human Body Model	7500V
Charged Device Model	1500V

Thermal Information

Thermal Resistance (Typical)	θ_{JA} ($^\circ\text{C}/\text{W}$)	θ_{JC} ($^\circ\text{C}/\text{W}$)
8 Ld TDFN Package (Notes 4, 5)	50	17
Maximum Junction Temperature	+150 $^\circ\text{C}$	
Storage Temperature	-65 $^\circ\text{C}$ to +150 $^\circ\text{C}$	
Ambient Operating Temperature	-40 $^\circ\text{C}$ to +85 $^\circ\text{C}$	
Power Dissipation	see Figure 28	
Pb-Free Reflow Profile	see link below	
	http://www.intersil.com/pbfree/Pb-FreeReflow.asp	

CAUTION: Do not operate at or near the maximum ratings listed for extended periods of time. Exposure to such conditions may adversely impact product reliability and result in failures not covered by warranty.

NOTES:

- θ_{JA} is measured with the component mounted on a high effective thermal conductivity test board in free air. See Tech Brief [TB379](#) for details.
- For θ_{JC} , the "case temp" location is the center of the ceramic on the package underside.

Electrical Specifications $V_{DD} = 5V, V_{SS} = -5V, R_L = 1k\Omega$ to $0V, T_A = +25^\circ\text{C}$, Unless Otherwise Specified.

PARAMETER	DESCRIPTION	CONDITIONS	MIN (Note 6)	TYP	MAX (Note 6)	UNIT
POWER SUPPLY PERFORMANCE						
$V_{DD} - V_{SS}$	Supply Voltage Range		4.5		19	V
I_S	Supply Current	No load		2.1	2.8	mA
PSRR	Power Supply Rejection Ratio	V_S is moved from $\pm 2.25V$ to $\pm 9.5V$	60	80		dB
INPUT CHARACTERISTICS						
V_{OS}	Input Offset Voltage	$V_{CM} = 0V$		1.4	15	mV
TCV_{OS}	Average Offset Voltage Drift (Note 7)			1		$\mu\text{V}/^\circ\text{C}$
I_{LEAK}	Input Leakage Current	$V_{CM} = 0V$		2	10	nA
R_{IN}	Input Resistance			1		$G\Omega$
C_{IN}	Input Capacitance			2		pF
CMIR	Common-Mode Input Range		$V_{SS} - 0.5$		$V_{DD} + 0.5$	V
CMRR	Common-Mode Rejection Ratio	For V_{IN} from -5.5V to 5.5V	50	70		dB
A_{VOL}	Open-Loop Gain	$-4.5V \leq V_{OUT} \leq 4.5V$	75	100		dB
OUTPUT CHARACTERISTICS						
V_{OH}	Output Swing High	$I_L = 5mA, V_{IN} = V_{DD}$	$V_{DD} - 0.15$	$V_{DD} - 0.025$		V
V_{OL}	Output Swing Low	$I_L = -5mA, V_{IN} = V_{SS}$		$V_{SS} + 0.025$	$V_{SS} + 0.15$	V
I_{SC}	Short-Circuit Current			± 1.0		A
I_{OUT}	Continuous Output Current (Note 10)			± 300		mA
DYNAMIC PERFORMANCE						
SR	Slew Rate (Note 8)	$-4.0V \leq V_{OUT} \leq 4.0V$		18		V/ μs
t_s	Settling to 0.1% (Note 9)	$A_V = +1, V_0 = 2V$ step		80		ns
BW	-3dB Bandwidth	$A_V = +1, R_L = 1k\Omega, C_L = 8pF$		25		MHz
PM	Phase Margin	$R_L = 1k\Omega, C_L = 8pF$		44		$^\circ$
THERMAL PERFORMANCE						
T_{TS}	Thermal Shutdown Temperature	Die temperature at which the device will shutdown until it cools by T_{TSH} $^\circ\text{C}$		+165		$^\circ\text{C}$
T_{TSH}	Thermal Shutdown Hysteresis	Die temperature below T_{TS} $^\circ\text{C}$ when the device will become operational after shutdown		15		$^\circ\text{C}$

Electrical Specifications $V_{DD} = 5V, V_{SS} = GND = 0V, R_L = 1k\Omega$ to 2.5V, $T_A = +25^\circ C$, Unless Otherwise Specified.

PARAMETER	DESCRIPTION	CONDITION	MIN (Note 6)	TYP	MAX (Note 6)	UNIT
POWER SUPPLY PERFORMANCE						
$V_{DD} - V_{SS}$	Supply Voltage Range		4.5		19	V
I_S	Supply Current	No load		2.0	2.8	mA
PSRR	Power Supply Rejection Ratio	V_S is moved from +4.5V to +19V	60	80		dB
INPUT CHARACTERISTICS						
V_{OS}	Input Offset Voltage	$V_{CM} = 2.5V$		1.4	15	mV
TCV_{OS}	Average Offset Voltage Drift (Note 7)			1		$\mu V/^\circ C$
I_{LEAK}	Input Leakage Current	$V_{CM} = 2.5V$		2	10	nA
R_{IN}	Input Resistance			1		$G\Omega$
C_{IN}	Input Capacitance			2		pF
CMIR	Common-Mode Input Range		$V_{SS} - 0.5$		$V_{DD} + 0.5$	V
CMRR	Common-Mode Rejection Ratio	For V_{IN} from -0.5V to 5.5V	45	70		dB
A_{VOL}	Open-Loop Gain	$0.5V \leq V_{OUT} \leq 4.5V$	70	100		dB
OUTPUT CHARACTERISTICS						
V_{OH}	Output Swing High	$I_L = 5mA, V_{IN} = V_{DD}$	$V_{DD} - 0.15$	$V_{DD} - 0.025$		V
V_{OL}	Output Swing Low	$I_L = -5mA, V_{IN} = V_{SS}$		$V_{SS} + 0.025$	$V_{SS} + 0.15$	V
I_{SC}	Short-Circuit Current			± 0.5		A
I_{OUT}	Continuous Output Current (Note 10)			± 300		mA
DYNAMIC PERFORMANCE						
SR	Slew Rate (Note 8)	$1V \leq V_{OUT} \leq 4V$		15		$V/\mu s$
t_s	Settling to 0.1% (Note 9)	$A_V = +1, V_O = 2V$ step		80		ns
BW	-3dB Bandwidth	$A_V = +1, R_L = 1k\Omega, C_L = 8pF$		22		MHz
PM	Phase Margin	$R_L = 1k\Omega, C_L = 8pF$		46		$^\circ$
THERMAL PERFORMANCE						
T_{TS}	Thermal Shutdown Temperature	Die temperature at which the device will shutdown until it cools by T_{TSH} $^\circ C$		+165		$^\circ C$
T_{TSH}	Thermal Shutdown Hysteresis	Die temperature below T_{TS} $^\circ C$ when the device will become operational after shutdown		15		$^\circ C$

Electrical Specifications $V_{DD} = 15V, V_{SS} = GND = 0V, R_L = 1k\Omega$ to 7.5V, $T_A = +25^\circ C$, Unless Otherwise Specified.

PARAMETER	DESCRIPTION	CONDITION	MIN (Note 6)	TYP	MAX (Note 6)	UNIT
POWER SUPPLY PERFORMANCE						
$V_{DD} - V_{SS}$	Supply Voltage Range		4.5		19	V
I_S	Supply Current	No load		2.2	2.8	mA
PSRR	Power Supply Rejection Ratio	V_S is moved from +4.5V to +19V	60	80		dB
INPUT CHARACTERISTICS						
V_{OS}	Input Offset Voltage	$V_{CM} = 7.5V$		1.4	15	mV
TCV_{OS}	Average Offset Voltage Drift (Note 7)			1		$\mu V/^\circ C$

Electrical Specifications $V_{DD} = 15V$, $V_{SS} = GND = 0V$, $R_L = 1k\Omega$ to $7.5V$, $T_A = +25^\circ C$, Unless Otherwise Specified. (Continued)

PARAMETER	DESCRIPTION	CONDITION	MIN (Note 6)	TYP	MAX (Note 6)	UNIT
I_{LEAK}	Input Leakage Current	$V_{CM} = 7.5V$		2	10	nA
R_{IN}	Input Resistance			1		$G\Omega$
C_{IN}	Input Capacitance			2		pF
CMIR	Common-Mode Input Range		$V_{SS} - 0.5$		$V_{DD} + 0.5$	V
CMRR	Common-Mode Rejection Ratio	For V_{IN} from $-0.5V$ to $15.5V$	50	70		dB
A_{VOL}	Open-Loop Gain	$0.5V \leq V_{OUT} \leq 14.5V$	75	95		dB
OUTPUT CHARACTERISTICS						
V_{OH}	Output Swing High	$I_L = 100mA, V_{IN} = V_{DD}$		$V_{DD} - 0.4$		V
		$I_L = 7.5mA, V_{IN} = V_{DD}$	$V_{DD} - 0.15$	$V_{DD} - 0.025$		V
V_{OL}	Output Swing Low	$I_L = -100mA, V_{IN} = V_{SS}$		$V_{SS} + 0.4$		V
		$I_L = -7.5mA, V_{IN} = V_{SS}$		$V_{SS} + 0.025$	$V_{SS} + 0.15$	V
I_{SC}	Short-Circuit Current			± 1.0		A
I_{OUT}	Continuous Output Current (Note 10)			± 300		mA
DYNAMIC PERFORMANCE						
SR	Slew Rate (Note 8)	$1V \leq V_{OUT} \leq 14V$		19		V/ μs
t_s	Settling to 0.1% (Note 9)	$A_V = +1, V_O = 2V$ step		80		ns
BW	-3dB Bandwidth	$A_V = +1, R_L = 1k\Omega, C_L = 8pF$		27		MHz
PM	Phase Margin	$R_L = 1k\Omega, C_L = 8pF$		42		$^\circ$
THERMAL PERFORMANCE						
T_{TS}	Thermal Shutdown Temperature	Die temperature at which the device will shutdown until it cools by T_{TSH} $^\circ C$		+165		$^\circ C$
T_{TSH}	Thermal Shutdown Hysteresis	Die temperature below T_{TS} $^\circ C$ when the device will become operational after shutdown		15		$^\circ C$

NOTES:

- Compliance to datasheet limits is assured by one or more methods: production test, characterization and/or design.
- Measured over the $-40^\circ C$ to $+85^\circ C$ ambient operating temperature range.
- Typical slew rate is an average of the slew rates measured on the rising (20% to 80%) and the falling (80% to 20%) edges of the output signal.
- Settling time measured from [Full Scale - (0.1%*StepSize)] on the rising edge to when the output is bounded within $\pm 0.1\%$ of full scale.
- Continuous output current with a typical of $\pm 300mA$. Care should be taken to ensure the maximum package power dissipation is not exceeded, refer to "Power Dissipation" on page 10.

Pin Descriptions

PIN NUMBER	PIN NAME	PIN TYPE	PIN FUNCTION
1, 5, 8	NC		No Connection
2	INN	Analog Input	Amplifier negative input
3	INP	Analog Input	Amplifier positive input
4	VSS	Analog Power	Negative power supply (connect to GND for single supply operation)
6	OUT	Analog Output	Amplifier output
7	VDD	Analog Power	Positive power supply

Typical Performance Curves

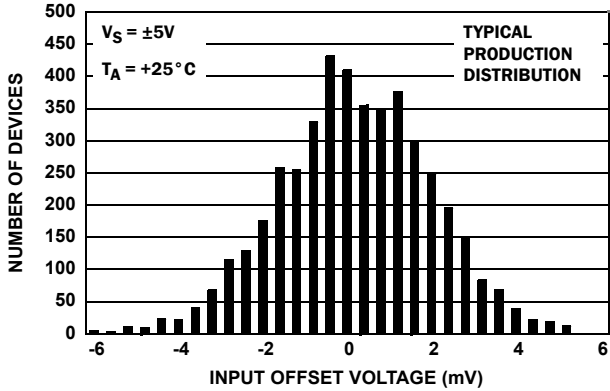

FIGURE 1. INPUT OFFSET VOLTAGE DISTRIBUTION

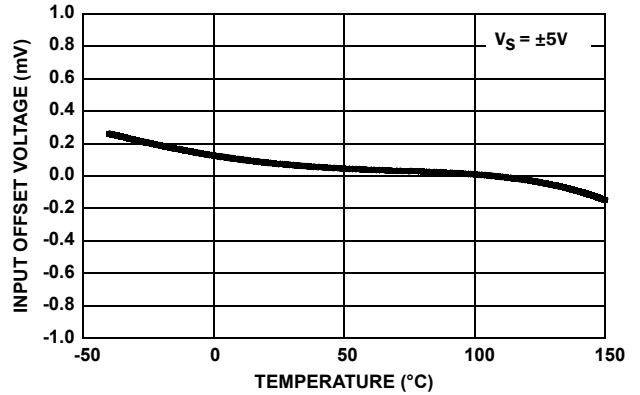

FIGURE 2. INPUT OFFSET VOLTAGE vs TEMPERATURE

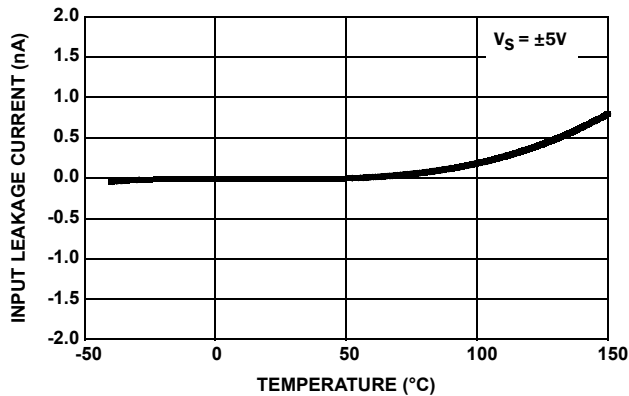

FIGURE 3. INPUT LEAKAGE CURRENT vs TEMPERATURE

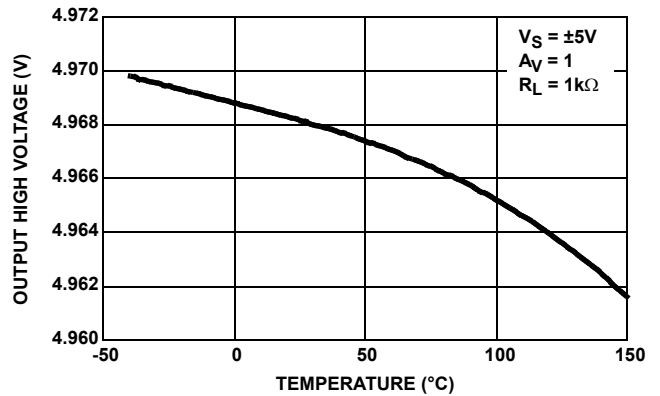

FIGURE 4. OUTPUT HIGH VOLTAGE vs TEMPERATURE

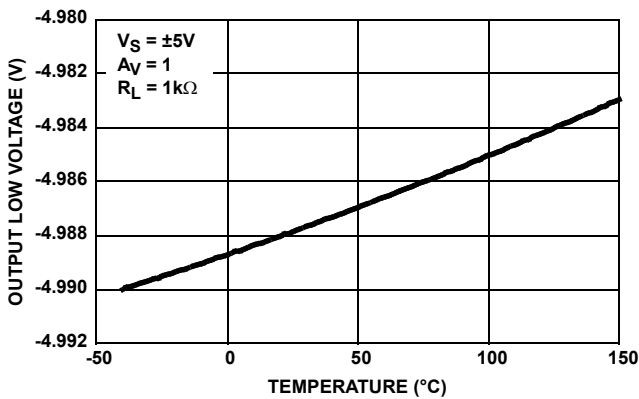

FIGURE 5. OUTPUT LOW VOLTAGE vs TEMPERATURE

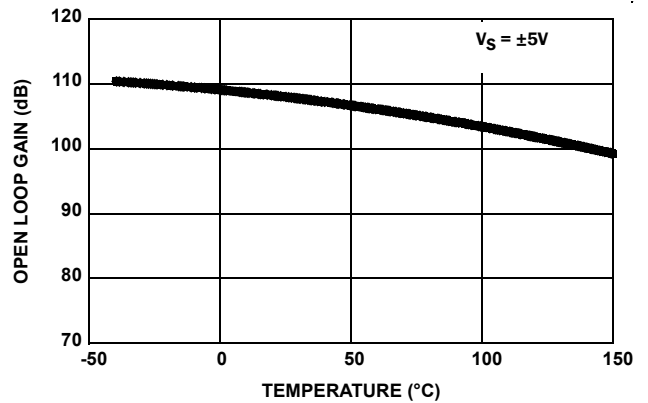

FIGURE 6. OPEN-LOOP GAIN vs TEMPERATURE

Typical Performance Curves (Continued)

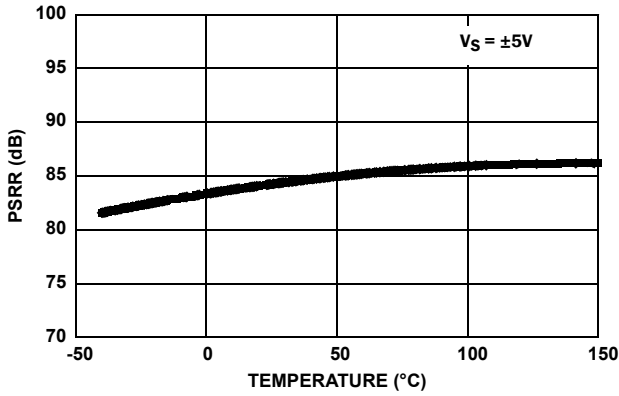

FIGURE 7. PSRR vs TEMPERATURE

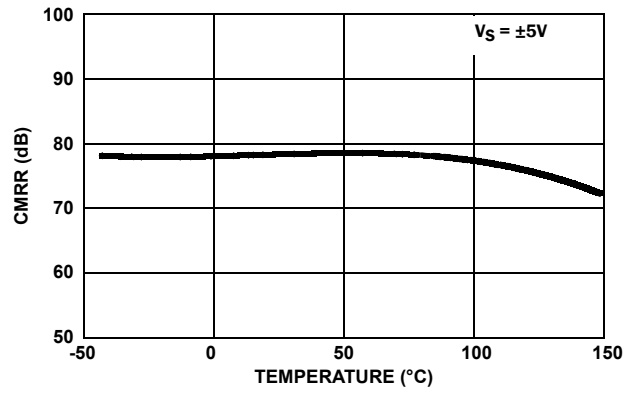

FIGURE 8. CMRR vs TEMPERATURE

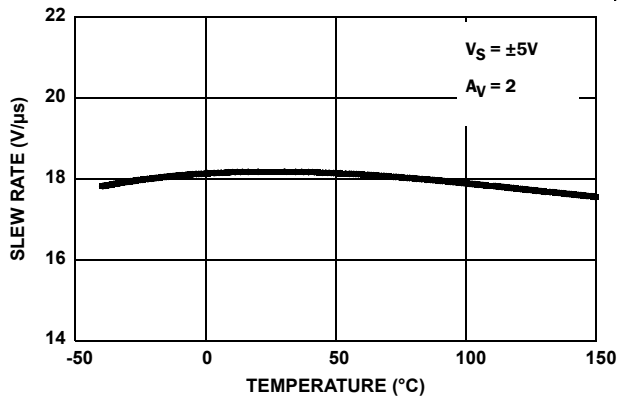

FIGURE 9. SLEW RATE vs TEMPERATURE

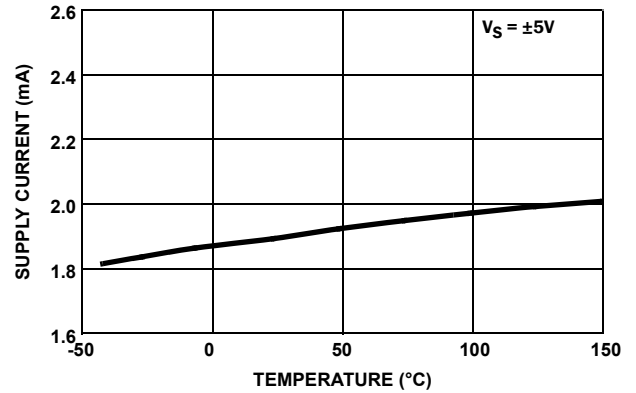

FIGURE 10. SUPPLY CURRENT vs TEMPERATURE

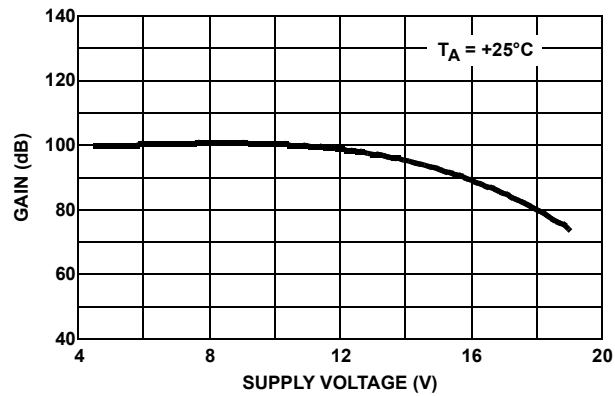

FIGURE 11. OPEN-LOOP GAIN vs SUPPLY VOLTAGE

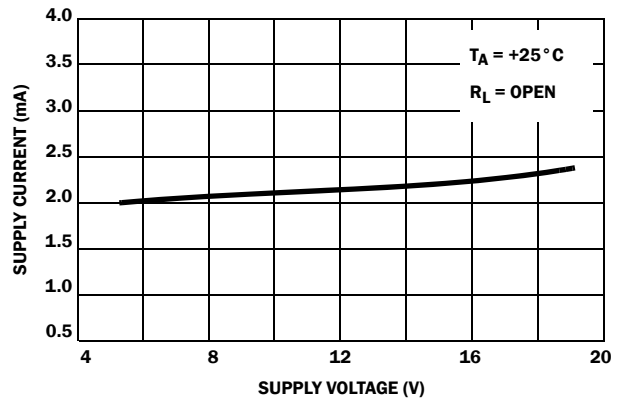

FIGURE 12. SUPPLY CURRENT vs SUPPLY VOLTAGE

Typical Performance Curves (Continued)

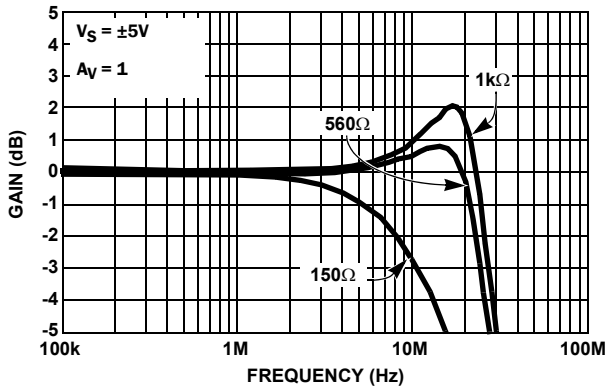

FIGURE 13. FREQUENCY RESPONSE FOR VARIOUS R_L

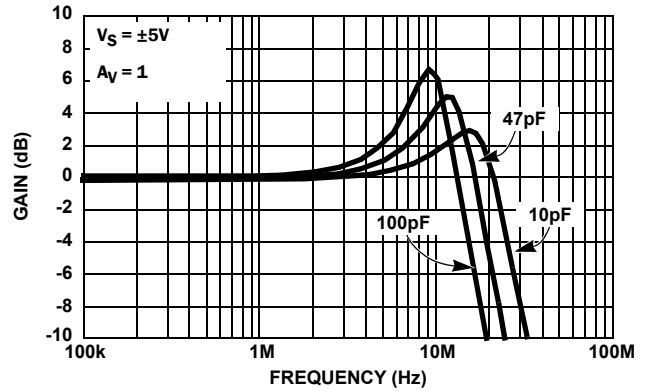

FIGURE 14. FREQUENCY RESPONSE FOR VARIOUS C_L

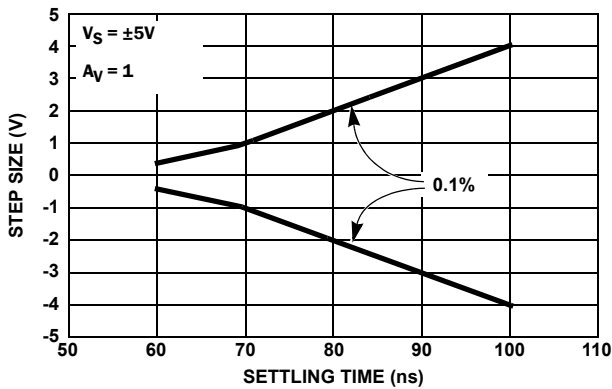

FIGURE 15. STEP SIZE vs SETTLING TIME

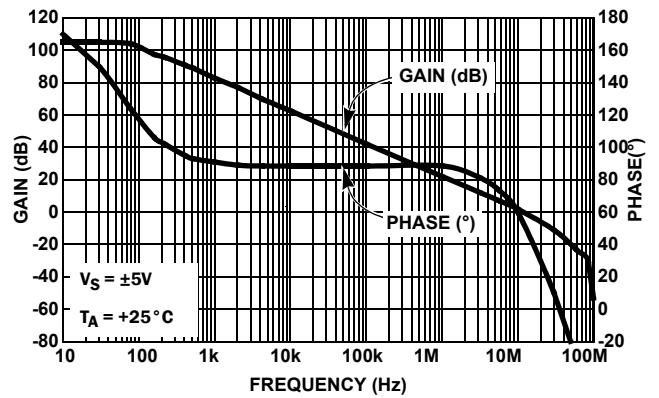

FIGURE 16. OPEN LOOP GAIN AND PHASE

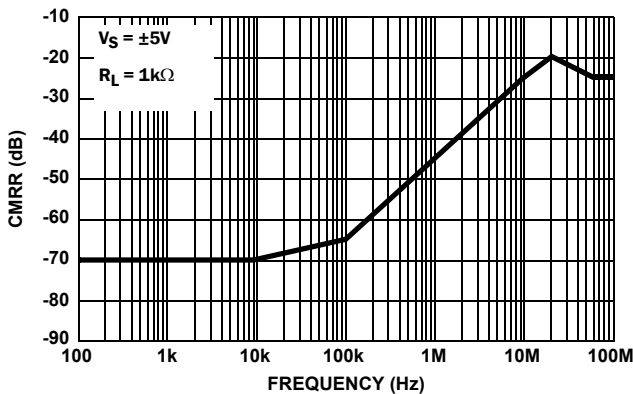

FIGURE 17. CMRR vs FREQUENCY

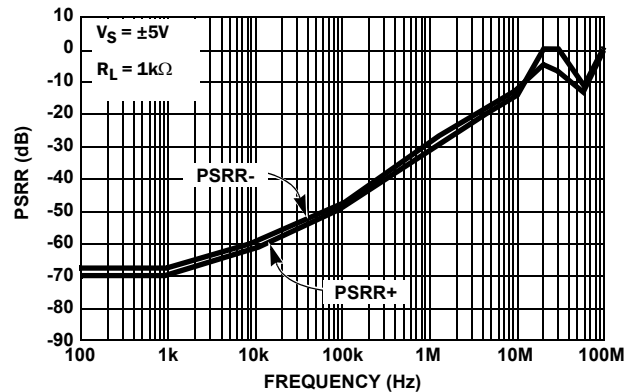

FIGURE 18. PSRR vs FREQUENCY

Typical Performance Curves (Continued)

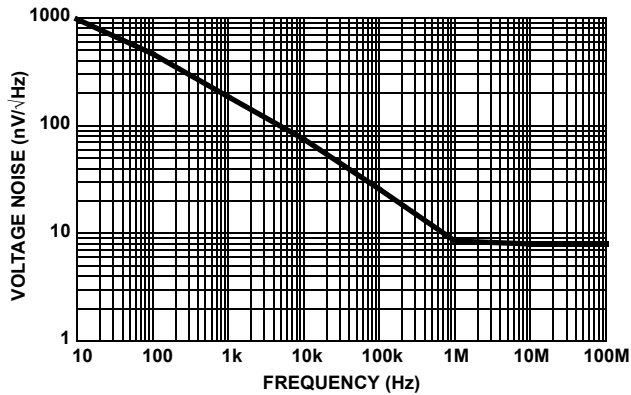

FIGURE 19. INPUT VOLTAGE NOISE SPECTRAL DENSITY

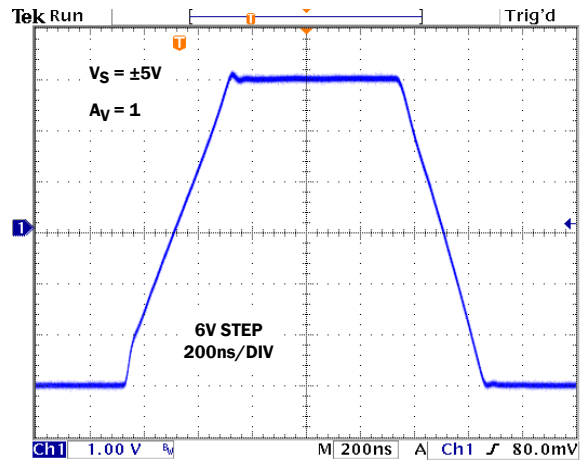

FIGURE 20. LARGE SIGNAL TRANSIENT RESPONSE

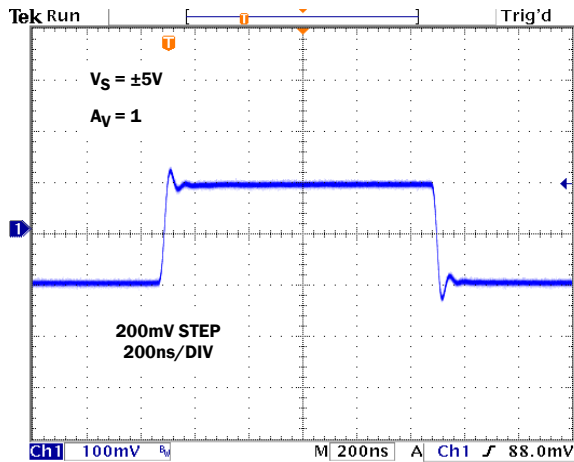

FIGURE 21. SMALL SIGNAL TRANSIENT RESPONSE

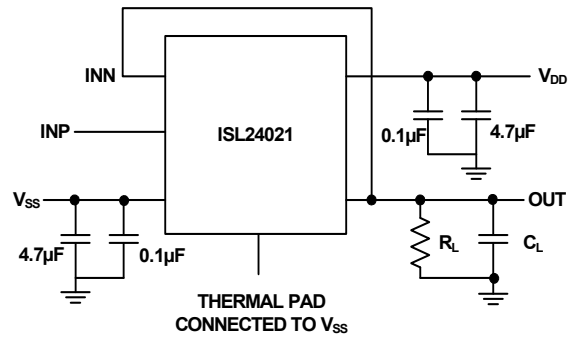

FIGURE 22. TEST CIRCUIT

Applications Information

Product Description

The ISL24021 is a high output current, high voltage, rail-to-rail voltage feedback amplifier. The ISL24021 is capable of $\pm 1\text{A}$ peak output short circuit current. The amplifier exhibits beyond the rail input capability, rail-to-rail output capability and is unity gain stable. Other features include fast slew rate and settling time which is important in many applications, such as TFT-LCD panels.

The ISL24021 is available in a 8 Ld 3mmx3mm TDFN package featuring a standard operational amplifier pinout and a lead pitch of 0.65mm. The device utilizes a thermally enhanced package and has a built-in thermal protection circuit. It is specified for operation over an ambient temperature range of -40°C to $+85^\circ\text{C}$.

Operating Voltage, Input and Output Capability

The ISL24021 can operate on a single supply or dual supply configuration. The ISL24021 operating voltage ranges from a minimum of 4.5V to a maximum of 19V. This range allows for a standard 5V (or $\pm 2.5\text{V}$) supply voltage to dip to -10%, or a standard 18V (or $\pm 9\text{V}$) to rise by +5.5% without affecting performance or reliability.

The input common mode voltage range extends 0.5V beyond the supply rails. For this range, the ISL24021 amplifier is immune to phase reversal. If the common mode input voltage exceeds the supply voltage by more than 0.5V, electrostatic protection diodes in the input stage of the device begin to conduct. It is suggested to not overdrive the inputs. Figure 23 shows the input voltage driven beyond the supply rails and the device output swinging between the supply rails.

The output swings of the ISL24021 typically extend to within 25mV of positive and negative supply rails with load currents of $\pm 5\text{mA}$. Decreasing load currents will extend the output voltage range even closer to the supply rails. Figure 24 shows the input and output waveforms for the device in a unity-gain configuration. Operation is from $\pm 5\text{V}$ supply with a $1\text{k}\Omega$ load connected to GND. The input is a $10\text{V}_{\text{P-P}}$ sinusoid and the output voltage is approximately $9.95\text{V}_{\text{P-P}}$.

Refer to the "Electrical Specifications" tables beginning on page 2 for specific device parameters. Parameter variations with operating voltage, loading and/or temperature are shown in the "Typical Performance Curves" on page 5.

$V_S = \pm 2.5\text{V}$, $T_A = +25^\circ\text{C}$, $A_V = 1$, $V_{\text{IN}} = 6\text{V}_{\text{P-P}}$

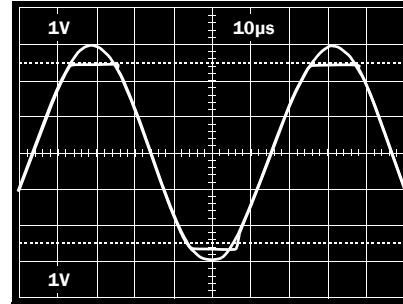

FIGURE 23. OPERATION WITH BEYOND-THE-RAILS INPUT

$V_S = \pm 5\text{V}$, $T_A = +25^\circ\text{C}$, $A_V = 1$, $V_{\text{IN}} = 10\text{V}_{\text{P-P}}$

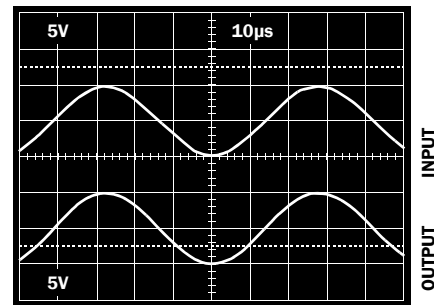

FIGURE 24. OPERATION WITH RAIL-TO-RAIL INPUT AND OUTPUT

Output Current Limit

The ISL24021 is capable of $\pm 1\text{A}$ peak output short circuit current. The device will limit the current to $\pm 1\text{A}$. Maximum reliability is maintained if the output continuous current never exceeds $\pm 300\text{mA}$. This limit is set by the characteristics of the internal metal interconnects. See "Power Dissipation" on page 10 for detailed information about ensuring device operation with temperature and load conditions.

Driving Capacitive Loads

As load capacitance increases, the -3dB bandwidth will decrease and peaking can occur. Depending on the application, it may be necessary to reduce peaking and to improve device stability. To improve device stability a snubber circuit or a series resistor may be added to the output of the ISL24021.

A snubber is a shunt load consisting of a resistor in series with a capacitor, see Figure 25. An optimized snubber can improve the phase margin and the stability of the ISL24021. The advantage of a snubber circuit is that it does not draw any DC load current or reduce the gain.

Another method to reduce peaking is to add a series output resistor (typically between 1Ω to 10Ω ; see Figure 26). Depending on the capacitive loading, a small value resistor may be the most appropriate choice to minimize any reduction in gain.

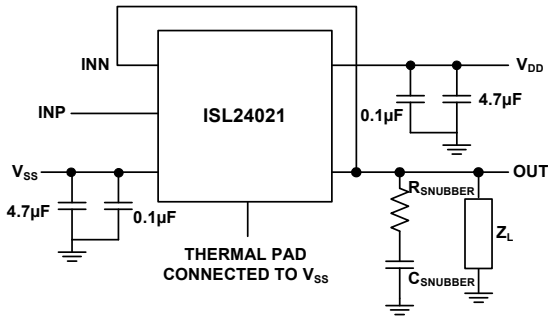

FIGURE 25. OUTPUT SNUBBER CIRCUIT

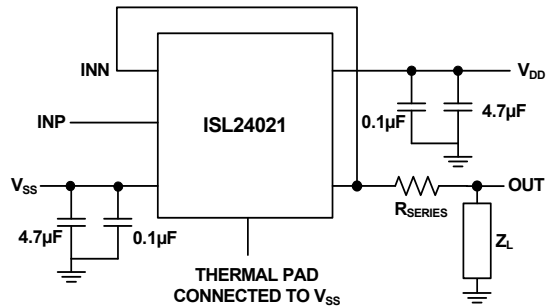

FIGURE 26. OUTPUT SERIES RESISTOR CIRCUIT

Typical Application Circuit

A typical application of the ISL24021 is as a TFT-LCD VCOM driver (see Figure 27). A VCOM driver maintains the backplane common voltage of a TFT-LCD panel. Maintaining the VCOM voltage at a steady level is critical to panel performance. The ability of the ISL24021 to source/sink large peak short circuit currents make it ideal as a VCOM driver. The ±1A short circuit current capability combined with a large bandwidth and fast settling time give the ISL24021 ideal VCOM driver characteristics, and make it a great choice for TFT-LCD applications.

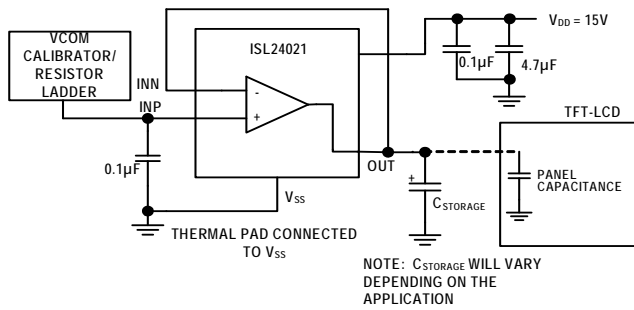

FIGURE 27. TYPICAL APPLICATION CIRCUIT: TFT-LCD VCOM

Power Dissipation

With a 300mA maximum continuous output drive capability, it is possible to exceed the rated +150°C maximum junction temperature. It is important to calculate the maximum power dissipation of the ISL24021 for the application. Proper load conditions will ensure that the ISL24021 junction temperature stays within a safe operating region.

The ISL24021 has a built-in thermal protection, which automatically shuts the output OFF (high impedance) when the die temperature reaches +165°C. This ensures safe operation and prevents internal damage to the device. When the die cools by +15°C the output will automatically turn ON.

The maximum power dissipation allowed in a package is determined according to Equation 1:

$$P_{DMAX} = \frac{T_{JMAX} - T_{AMAX}}{\theta_{JA}} \tag{EQ. 1}$$

where:

- T_{JMAX} = Maximum junction temperature
- T_{AMAX} = Maximum ambient temperature
- θ_{JA} = Thermal resistance of the package
- P_{DMAX} = Maximum power dissipation in the package

The actual maximum power dissipation of the IC is the total quiescent supply current, times the total power supply voltage, plus the power dissipation in the IC caused by the loading condition.

Sourcing:

$$P_{DMAX} = V_S \times I_S + [V_{DD} - V_{OUT}] \times I_{LOAD} \tag{EQ. 2}$$

Sinking:

$$P_{DMAX} = V_S \times I_S + [V_{OUT} - V_{SS}] \times I_{LOAD} \tag{EQ. 3}$$

- V_S = Total supply voltage range (V_{DD} - V_{SS})
- I_S = Device supply current
- V_{DD} = Positive supply voltage
- V_{SS} = Negative supply voltage
- V_{OUT} = Output voltage
- I_{LOAD} = Load current

Device overheating can be avoided by calculating the minimum resistive load condition, R_{LOAD}, resulting in the highest power dissipation. To find R_{LOAD}, set the two P_{DMAX} equations equal to each other and solve for V_{OUT}/I_{LOAD}. Reference the package power dissipation curve, Figure 28, for further information.

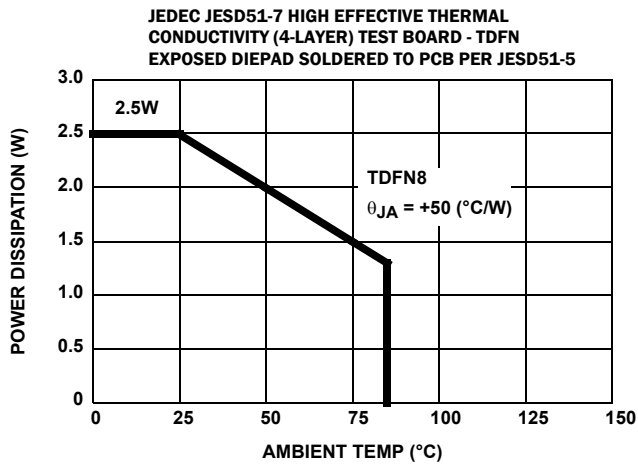

FIGURE 28. PACKAGE POWER DISSIPATION vs AMBIENT TEMPERATURE

Printed Circuit Board Layout

As with any high-frequency device, good printed circuit board layout is necessary for optimum performance. For the ISL24021 low impedance analog power and ground planes are recommended, and trace lengths should be as short as possible. The power supply pins must be well bypassed to reduce the risk of oscillation. For optimal thermal and operating performance the ISL24021 thermal pad should always be connected to the lowest potential, V_{SS} .

For normal single supply operation (the V_{SS} pin is connected to GND) a 4.7 μ F capacitor should be placed from V_{DD} to GND, then a parallel 0.1 μ F capacitor should be connected as close to the amplifier as possible. For dual supply operation the same bypassing techniques should be utilized by connecting capacitors from each supply to GND.

Revision History

The revision history provided is for informational purposes only and is believed to be accurate, but not warranted. Please go to web to make sure you have the latest revision.

DATE	REVISION	CHANGE
9/14/2011	FN6637.1	<p>Updated Ordering Information by Removing bulk part ISL24021IRT065Z, added T7A part, PKG DWG# changed from L8.3x3A to L8.3x3K, added MSL Note</p> <p>Changed Human Body Model from "3000V" to "7500V" Added to Abs Max Rating - Charged Device Model Updated Tja Note to Non direct attached at High Thermal conductivity Added to Thermal Information Tjc "17" and respective note.</p> <p>Electrical Spec Table - Updated Note from: Parameters with MIN and/or MAX limits are 100% tested at +25 °C, unless otherwise specified. Temperature limits established by characterization and are not production tested. To: Compliance to datasheet limits is assured by one or more methods: production test, characterization and/or design.</p> <p>Changed POD L8.3x3A to L8.3x3K.</p>
06/03/2009	FN6637.0	Initial Release

Products

Intersil Corporation is a leader in the design and manufacture of high-performance analog semiconductors. The Company's products address some of the industry's fastest growing markets, such as, flat panel displays, cell phones, handheld products, and notebooks. Intersil's product families address power management and analog signal processing functions. Go to www.intersil.com/products for a complete list of Intersil product families.

For a complete listing of Applications, Related Documentation and Related Parts, please see the respective device information page on intersil.com: [ISL24021](http://www.intersil.com/ISL24021)

To report errors or suggestions for this datasheet, please go to: www.intersil.com/askourstaff

FITs are available from our website at: <http://rel.intersil.com/reports/search.php>

© Copyright Intersil Americas LLC 2009-2011. All Rights Reserved.
 All trademarks and registered trademarks are the property of their respective owners.

For additional products, see www.intersil.com/en/products.html

Intersil products are manufactured, assembled and tested utilizing ISO9001 quality systems as noted in the quality certifications found at www.intersil.com/en/support/qualandreliability.html

Intersil products are sold by description only. Intersil may modify the circuit design and/or specifications of products at any time without notice, provided that such modification does not, in Intersil's sole judgment, affect the form, fit or function of the product. Accordingly, the reader is cautioned to verify that datasheets are current before placing orders. Information furnished by Intersil is believed to be accurate and reliable. However, no responsibility is assumed by Intersil or its subsidiaries for its use; nor for any infringements of patents or other rights of third parties which may result from its use. No license is granted by implication or otherwise under any patent or patent rights of Intersil or its subsidiaries.

For information regarding Intersil Corporation and its products, see www.intersil.com

Package Outline Drawing

L8.3x3K

8 LEAD DUAL FLAT NO-LEAD PLASTIC PACKAGE

Rev 0, 7/11

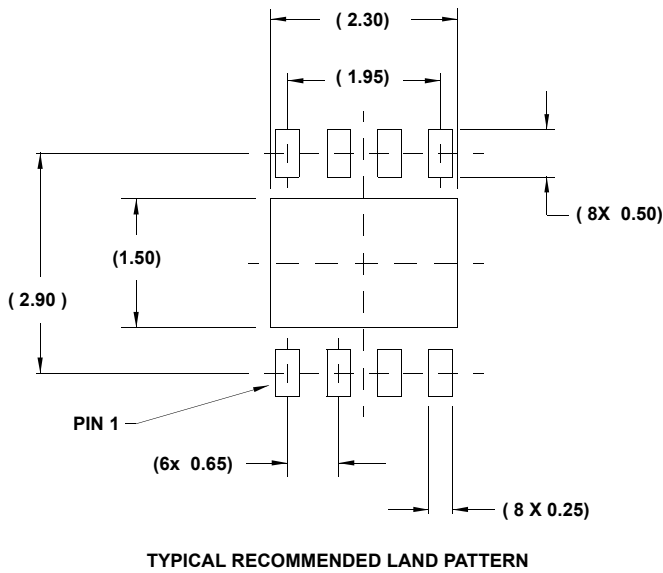
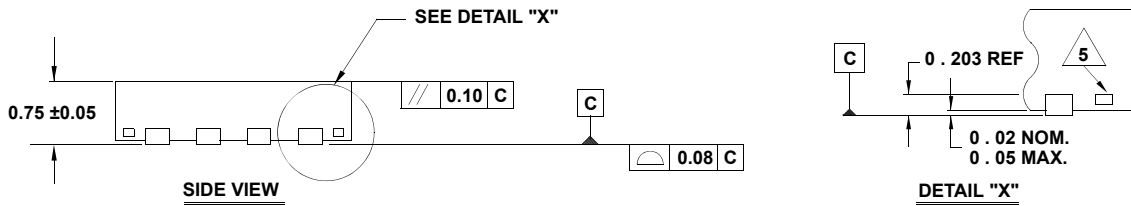
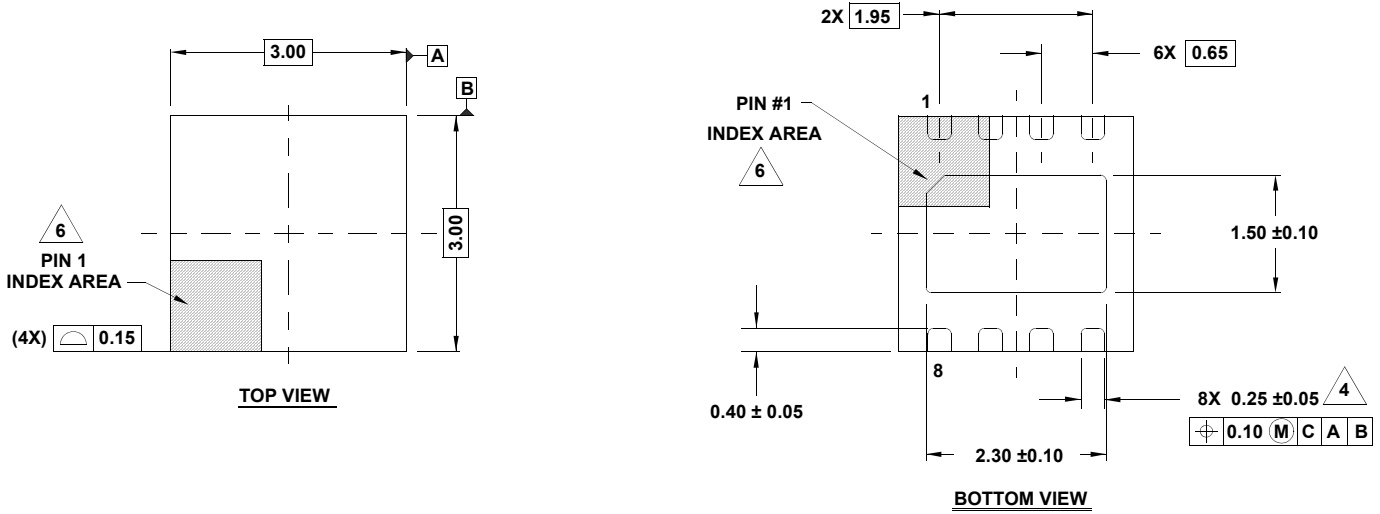

NOTES:

1. Dimensions are in millimeters.
Dimensions in () for Reference Only.
2. Dimensioning and tolerancing conform to AMSE Y14.5m-1994.
3. Unless otherwise specified, tolerance : Decimal ± 0.05
4. Dimension applies to the metallized terminal and is measured between 0.15mm and 0.20mm from the terminal tip.
5. Tiebar shown (if present) is a non-functional feature.
6. The configuration of the pin #1 identifier is optional, but must be located within the zone indicated. The pin #1 identifier may be either a mold or mark feature.
7. Compliant to JEDEC MO-229 WECC-2 except for the foot length.

Looking for pricing, stock, or lifecycle information?

Click below to explore more details on WIN SOURCE:

- [View ISL24021IRT065Z-T13 on WIN SOURCE](#)
- [Renesas Electronics America Information](#)

Optimize Your Supply Chain with WIN SOURCE Solutions

- ✓ Global Sourcing Solution
- ✓ Obsolete Management
- ✓ Cost Control Management
- ✓ Shortage Management
- ✓ Alternative Solution
- ✓ Excess Inventory Management