



**THE DATASHEET OF  
IRS2001MPBF**



### Features

- Floating channel designed for bootstrap operation
- Fully operational to +200V
- Tolerant to negative transient voltage, dV/dt immune
- Gate drive supply range from 10V to 20V
- Undervoltage lockout
- 3.3V, 5V, and 15V logic compatible
- Cross-conduction prevention logic
- Matched propagation delay for both channels
- Outputs in phase with inputs
- Leadfree, RoHS compliant

### Description

The IRS2001 is a high voltage, high speed power MOSFET and IGBT driver with dependent high and low side referenced output channels. Proprietary HVIC and latch immune CMOS technologies enable ruggedized monolithic construction. The logic input is compatible with standard CMOS or LSTTL output, down to 3.3V logic. The output drivers feature a high pulse current buffer stage designed for minimum driver cross-conduction. The floating channel can be used to drive an N-channel power MOSFET or IGBT in the high side configuration which operates up to 200V.

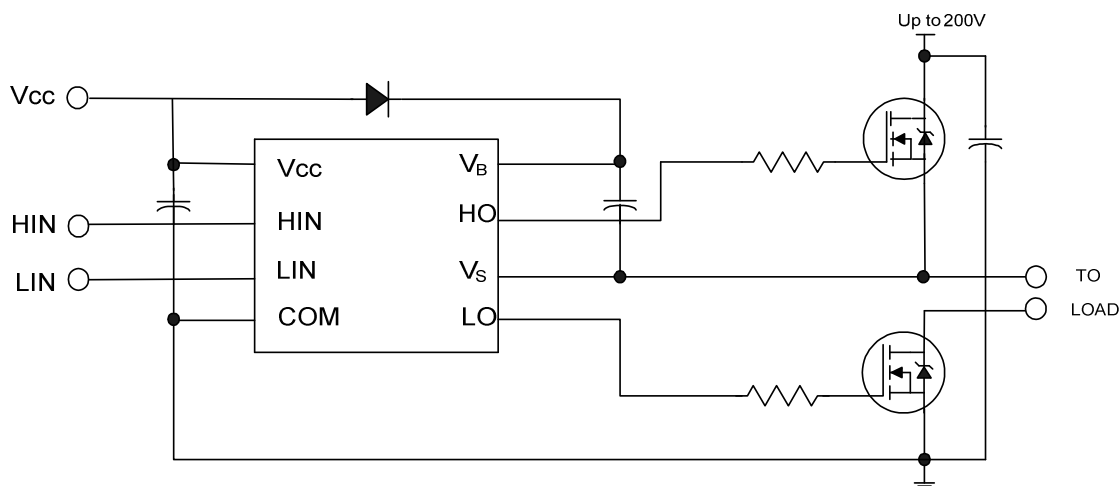
### Product Summary

Topology	General Driver
$V_{\text{OFFSET}}$	$\leq 200\text{V}$
$V_{\text{OUT}}$	10V – 20V
$I_{\text{o+}}$ & $I_{\text{o-}}$ (typical)	290mA & 600mA
$t_{\text{on}}$ & $t_{\text{off}}$ (typical)	160ns & 150ns
Delay Matching (Max.)	50ns

### Package Options



### Typical Connection



(Refer to Lead Assignments for correct pin configuration) This diagram shows electrical connections only. Please refer to our Application Notes and Design Tips for proper circuit board layout.

**Qualification Information<sup>†</sup>**

<b>Qualification Level</b>		Industrial <sup>††</sup> (per JEDEC JESD 47)	
		Comments: This IC has passed JEDEC’s Industrial qualification. IR’s Consumer qualification level is granted by extension of the higher Industrial level.	
<b>Moisture Sensitivity Level</b>		MLPQ4x4 14L	MSL2 <sup>†††</sup> (per IPC/JEDEC J-STD-020)
<b>ESD</b>	Machine Model	Class A (+/-200V) (per JEDEC standard JESD22-A115A)	
	Human Body Model	Class 1C (+/-2000V) (per JEDEC standard JESD22-A114F)	
	Charged Device Model	Class III (+/-1000V) (per JEDEC standard JESD22-C101D)	
<b>IC Latch-Up Test</b>		Class II, Level B (per AEC-Q100-004)	
<b>RoHS Compliant</b>		Yes	

† Qualification standards can be found at International Rectifier’s web site <http://www.irf.com/>

†† Higher qualification ratings may be available should the user have such requirements. Please contact your International Rectifier sales representative for further information.

††† Higher MSL ratings may be available for the specific package types listed here. Please contact your International Rectifier sales representative for further information.

### Absolute Maximum Ratings

Absolute Maximum Ratings indicate sustained limits beyond which damage to the device may occur. All voltage parameters are absolute voltages referenced to COM. The thermal resistance and power dissipation ratings are measured under board mounted and still air conditions.

Symbol	Definition	Min.	Max.	Units
$V_B$	High side floating absolute voltage	-0.3	225	V
$V_S$	High side floating supply offset voltage	$V_B - 25$	$V_B + 0.3$	
$V_{HO}$	High side floating output voltage	$V_S - 0.3$	$V_B + 0.3$	
$V_{CC}$	Low side and logic fixed supply voltage	-0.3	25	
$V_{LO}$	Low side output voltage	-0.3	$V_{CC} + 0.3$	
$V_{IN}$	Logic input voltage (HIN & LIN)	-0.3	$V_{CC} + 0.3$	
$dV_S/dt$	Allowable offset supply voltage transient	—	50	V/ns
$P_D$	Package power dissipation @ $T_A \leq 25^\circ\text{C}$	—	2.08	W
$R_{thJA}$	Thermal resistance, junction to ambient	—	36	$^\circ\text{C}/\text{W}$
$T_J$	Junction temperature	—	150	$^\circ\text{C}$
$T_S$	Storage temperature	-55	150	
$T_L$	Lead temperature (soldering, 10 seconds)	—	300	

### Recommended Operating Conditions

The input/output logic timing diagram is shown in Fig 1. For proper operation the device should be used within the recommended conditions. The  $V_S$  offset rating is tested with all supplies biased at 15V differential.

Symbol	Definition	Min.	Max.	Units
$V_B$	High side floating supply absolute voltage	$V_S + 10$	$V_S + 20$	V
$V_S$	High side floating supply offset voltage	†	200	
$V_{HO}$	High side floating output voltage	$V_S$	$V_B$	
$V_{CC}$	Low side and logic fixed supply voltage	10	20	
$V_{LO}$	Low side output voltage	0	$V_{CC}$	
$V_{IN}$	Logic input voltage	0	$V_{CC}$	
$T_A$	Ambient temperature	-40	125	$^\circ\text{C}$

† Logic operational for  $V_S$  of -5V to +200V. Logic state held for  $V_S$  of -5V to  $-V_{BS}$ . (Please refer to the Design Tip DT97-3 for more details).

### Dynamic Electrical Characteristics

$V_{BIAS} (V_{CC}, V_{BS}) = 15V$ ,  $C_L = 1000pF$ ,  $T_A = 25^\circ C$  unless otherwise specified.

Symbol	Definition	Min	Typ	Max	Units	Test Conditions
$t_{on}$	Turn-on propagation delay	—	160	220	ns	$V_S = 0V$
$t_{off}$	Turn-off propagation delay	—	150	220		$V_S = 200V$
$t_r$	Turn-on rise time	—	70	170		
$t_f$	Turn-off fall time	—	35	90		
MT	Delay Matching, HS & LS turn-on/off	—	—	50		

### Static Electrical Characteristics

$V_{BIAS}(V_{CC}, V_{BS}) = 15V$  and  $T_A = 25^\circ C$  unless otherwise specified. The  $V_{IN}$ ,  $V_{TH}$ , and  $I_{IN}$  parameters are referenced to COM. The  $V_O$  and  $I_O$  parameters are referenced to COM and are applicable to the respective output leads: HO and LO.

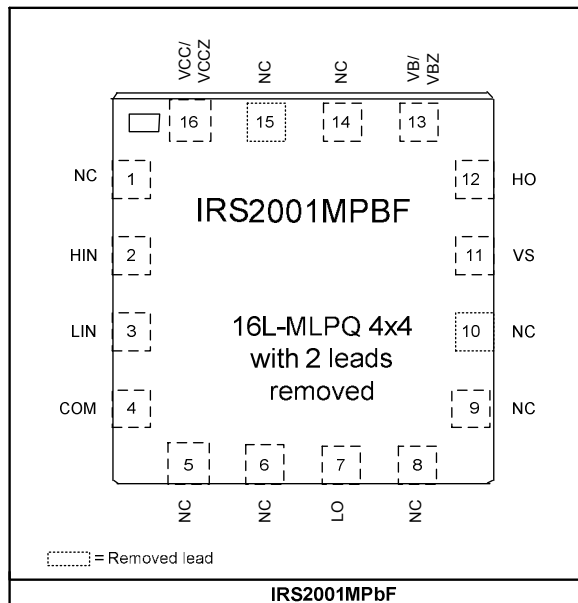
Symbol	Definition	Min	Typ	Max	Units	Test Conditions
$V_{IH}$	Logic “1” input voltage	2.5	—	—	V	$V_{CC} = 10V$ to $20V$
$V_{IL}$	Logic “0” input voltage	—	—	0.8		
$V_{OH}$	High level output voltage, $V_{BIAS} - V_O$	—	0.05	0.2		$I_O = 2mA$
$V_{OL}$	Low level output voltage, $V_O$	—	0.02	0.1		
$I_{LK}$	Offset supply leakage current	—	—	50	$\mu A$	$V_B = V_S = 200V$
$I_{QBS}$	Quiescent $V_{BS}$ supply current	—	30	55		$V_{IN} = 0V$ or $5V$
$I_{QCC}$	Quiescent $V_{CC}$ supply current	—	150	270		
$I_{IN+}$	Logic “1” input bias current	—	3	10		$V_{IN} = 5V$
$I_{IN-}$	Logic “0” input bias current	—	—	5		$V_{IN} = 0V$
$V_{CCUV+}$	$V_{CC}$ supply undervoltage positive going threshold	8.0	8.9	9.8	V	
$V_{CCUV-}$	$V_{CC}$ supply undervoltage negative going threshold	7.4	8.2	9.0		
$I_{O+}$	Output high short circuit pulsed current	200	290	—	mA	$V_O = 0V$ , $V_{IN} = \text{Logic “1”}$ $PW \leq 10 \mu s$
$I_{O-}$	Output low short circuit pulsed current	420	600	—		$V_O = 15V$ , $V_{IN} = \text{Logic “0”}$ $PW \leq 10 \mu s$



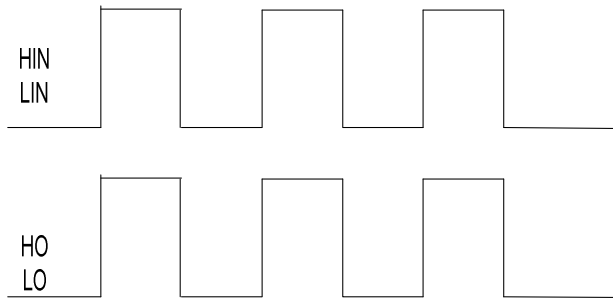
**Lead Definitions**

PIN	Symbol	Description
1	NC	No connection
2	HIN	Logic input for high side gate driver output (HO), in phase
3	LIN	Logic input for low side driver output (LO), in phase
4	COM	Low side return
5	NC	No Connection
6	NC	No Connection
7	LO	Low side gate drive output
8	NC	No Connection
9	NC	No Connection
10	NC	No Connection (pin removed)
11	V <sub>S</sub>	High side floating supply return
12	HO	High side gate drive output
13	V <sub>B</sub> /V <sub>BZ</sub>	High side floating supply
14	NC	No Connection
15	NC	No Connection (pin removed)
16	V <sub>CC</sub> /V <sub>CCZ</sub>	Low side and logic fixed supply

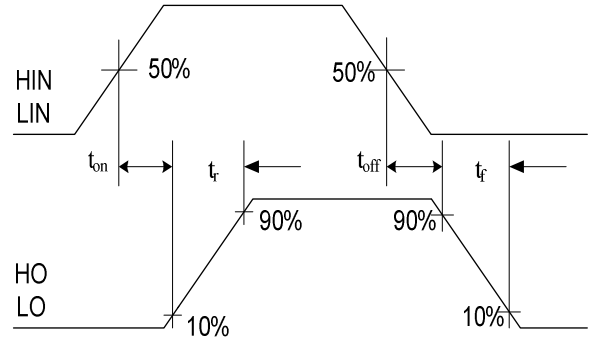
**Lead Assignments**



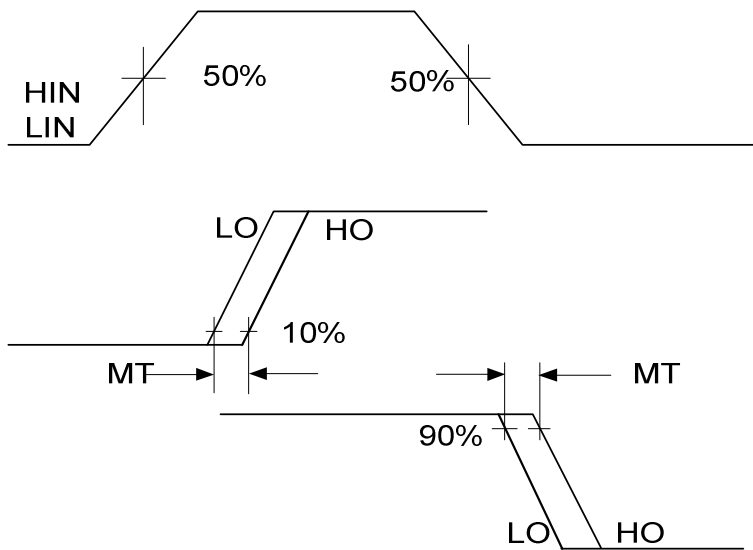
**Application Information and Additional Details**



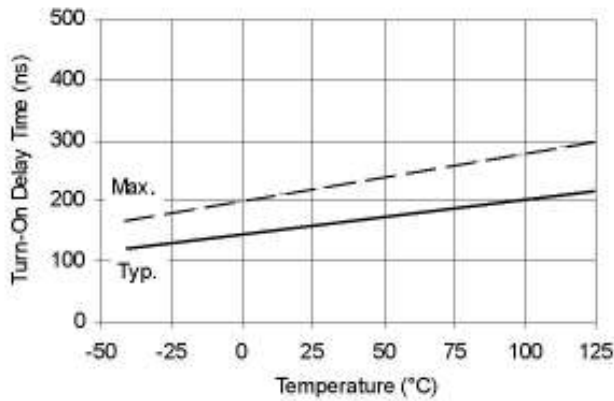
**Figure 1: Input/Output Timing Diagram**



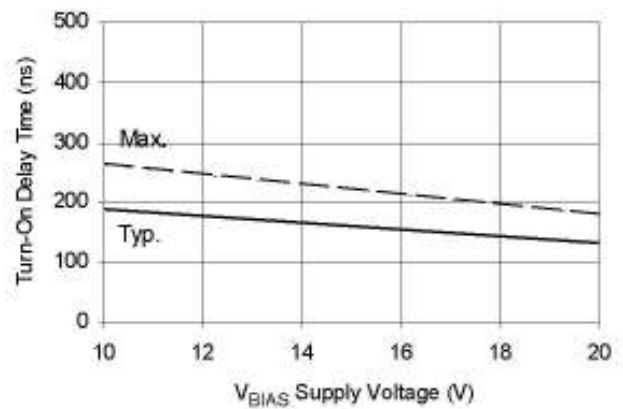
**Figure 2: Switching Time Waveform Definitions**



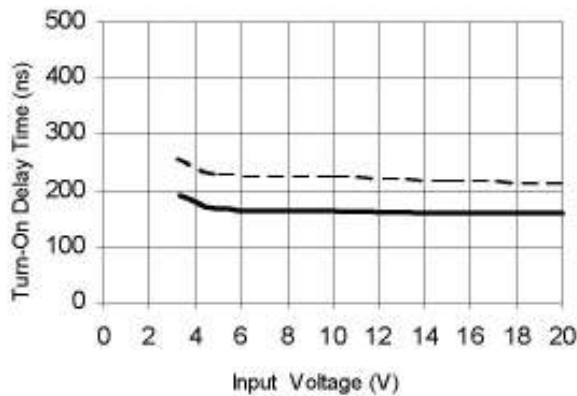
**Figure 3: Delay Matching Waveform Definitions**



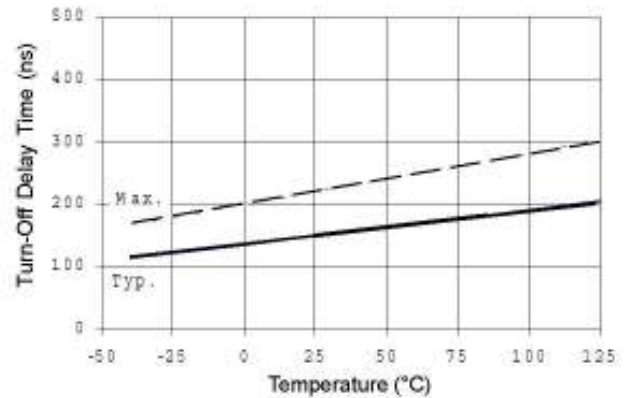
**Figure 6A. Turn-On Time vs. Temperature**



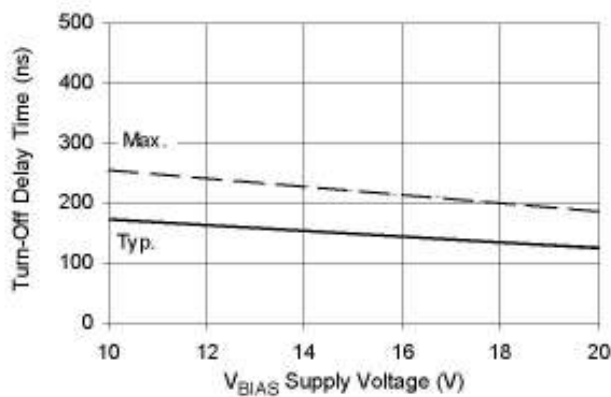
**Figure 6B. Turn-On Time vs. Supply Voltage**



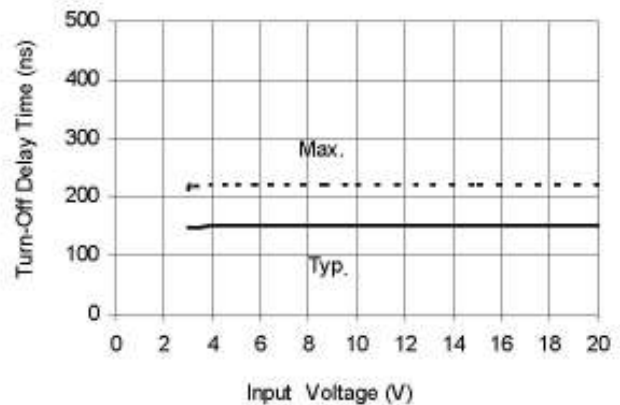
**Figure 6C. Turn-On Time vs. Input Voltage**



**Figure 7A. Turn-Off Time vs. Temperature**



**Figure 7B. Turn-Off Time vs. Supply Voltage**



**Figure 7C. Turn-Off Time vs. Input Voltage**

"Not recommended for new designs. For new designs we recommend IRS2005M"

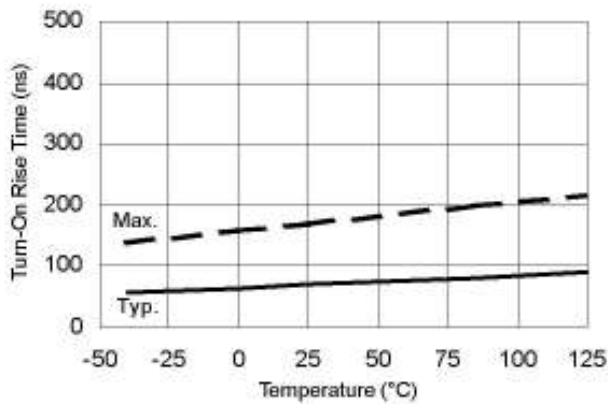


Figure 9A. Turn-On Rise Time vs. Temperature

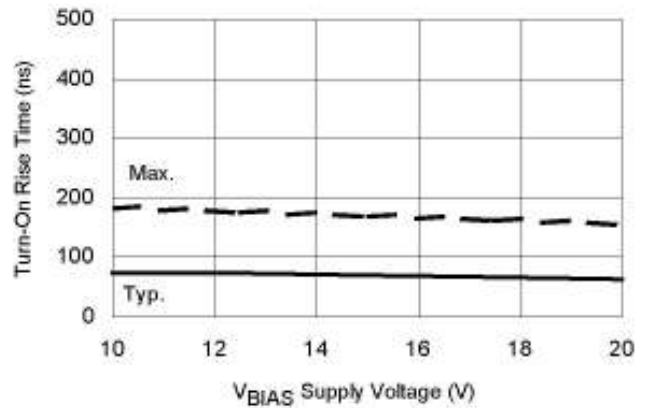


Figure 9B. Turn-On Rise Time vs. Voltage

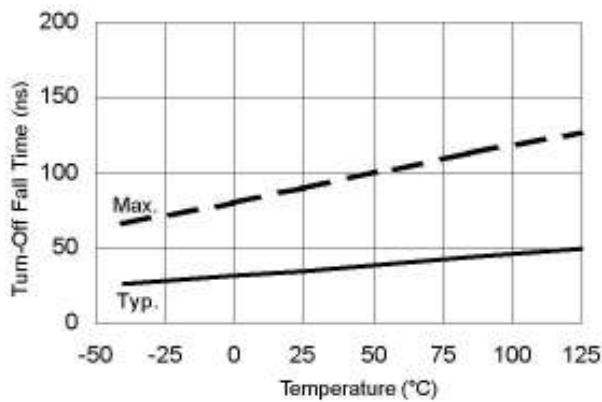


Figure 10A. Turn-Off Fall Time vs. Temperature

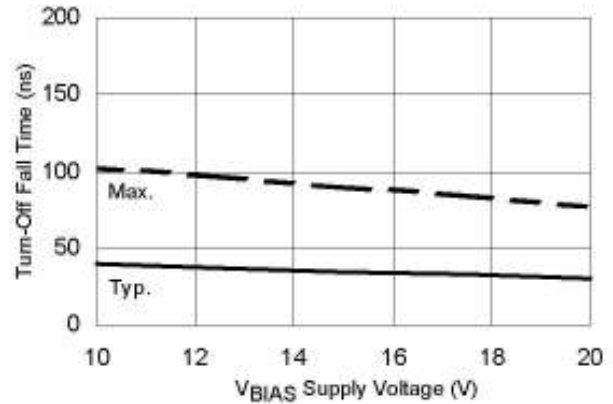


Figure 10B. Turn-Off Fall Time vs. Voltage

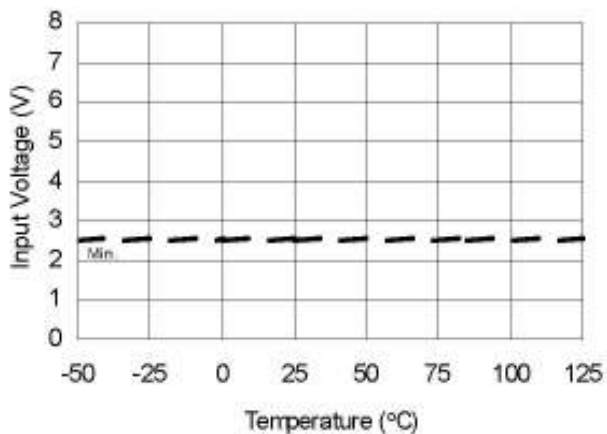


Figure 12A. Logic "1" Input Voltage vs. Temperature

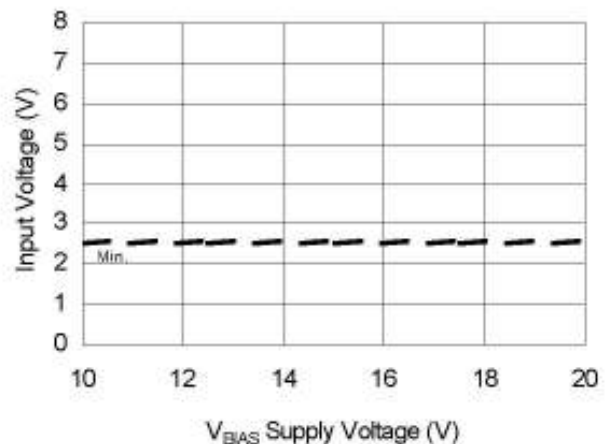
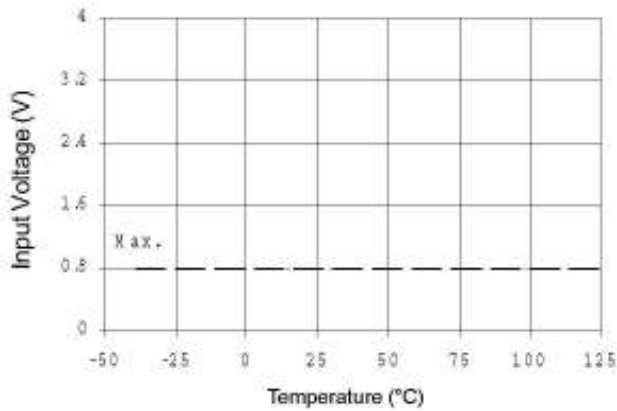
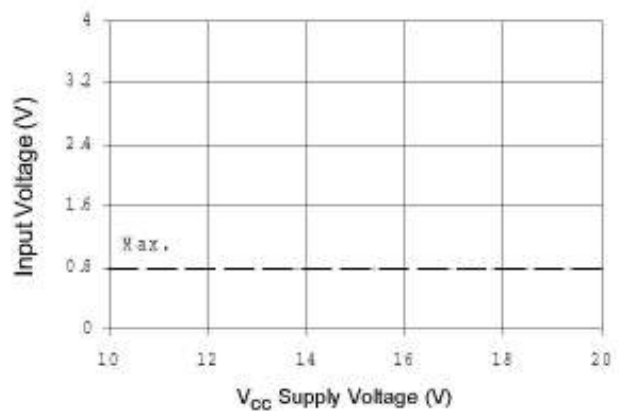


Figure 12B. Logic "1" Input Voltage vs. Voltage

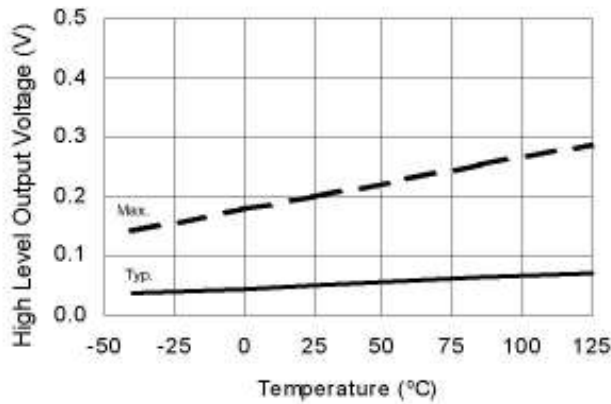
"Not recommended for new designs. For new designs we recommend IRS2005M"



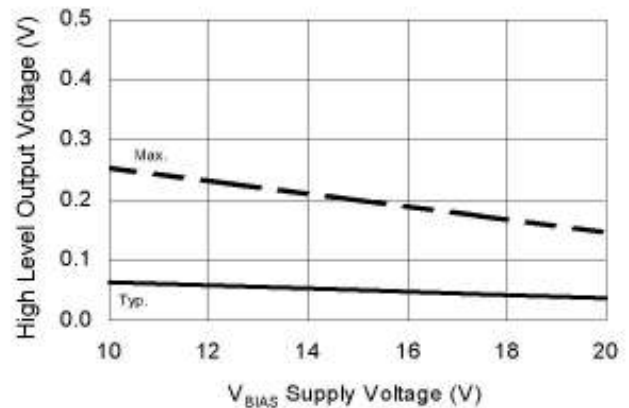
**Figure 13A. Logic "0" Input Voltage vs. Temperature**



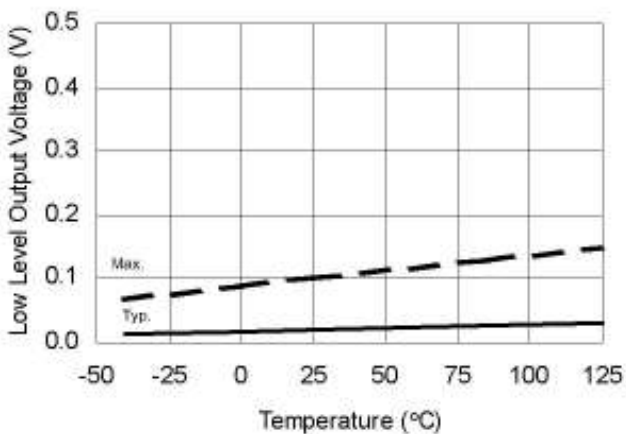
**Figure 13B. Logic "0" Input Voltage vs. Supply Voltage**



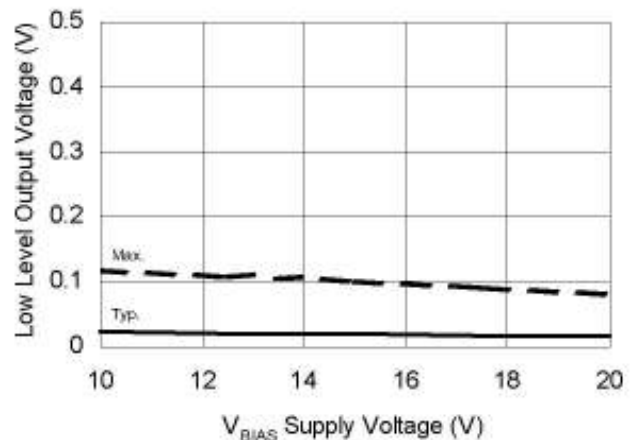
**Figure 14A. High Level Output Voltage vs. Temperature**



**Figure 14B. High Level Output vs. Supply Voltage**



**Figure 15A. Low Level Output Voltage vs. Temperature**



**Figure 15B. Low level Output vs. Supply Voltage**

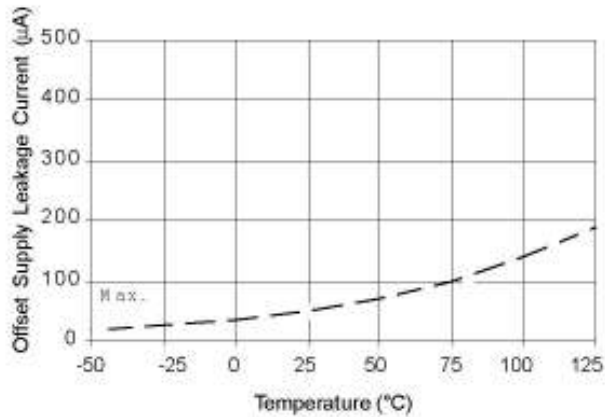


Figure 16A. Offset Supply Current vs. Temperature

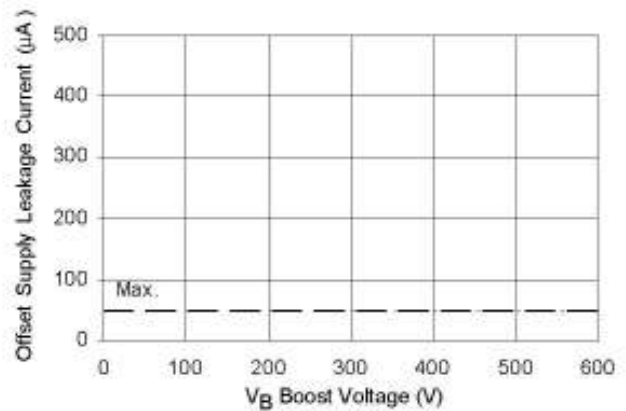


Figure 16B. Offset Supply Current vs. Voltage

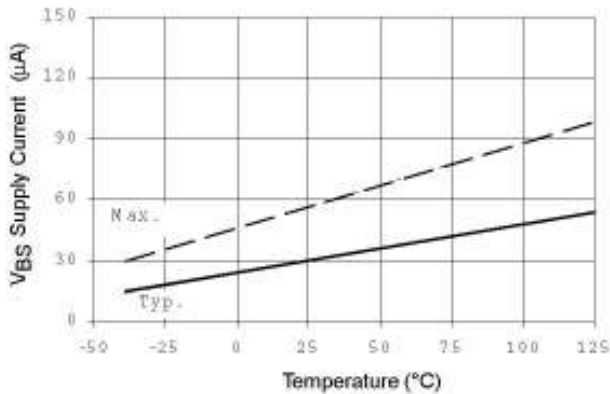


Figure 17A.  $V_{BS}$  Supply Current vs. Temperature

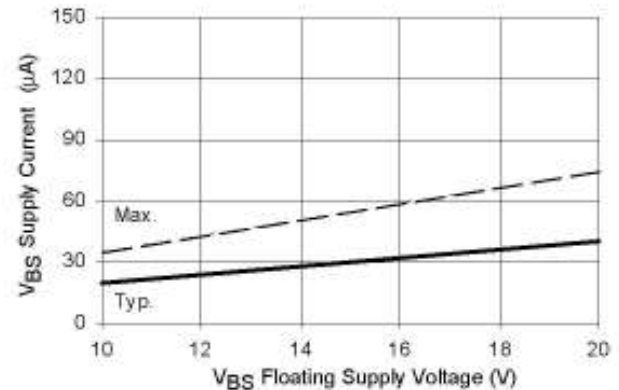


Figure 17B.  $V_{BS}$  Supply Current vs. Voltage

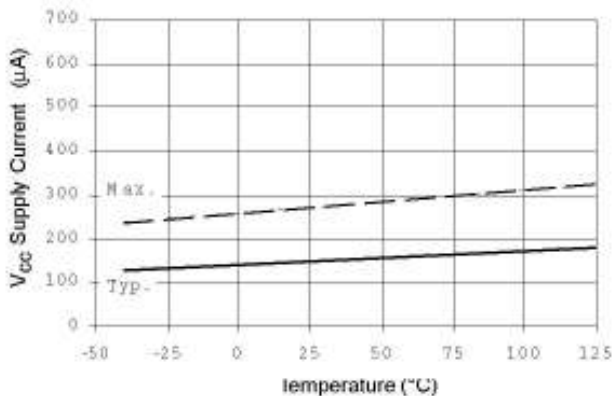


Figure 18A.  $V_{CC}$  Supply Current vs. Temperature

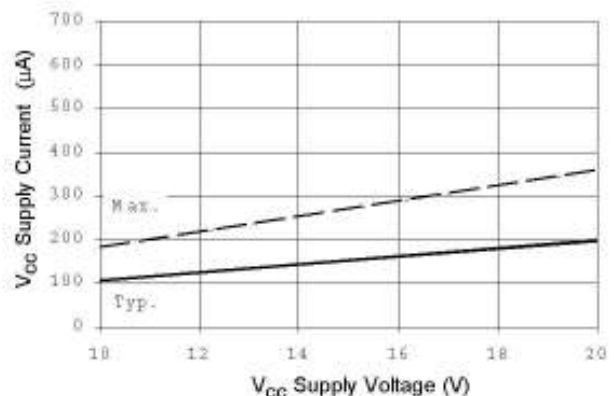
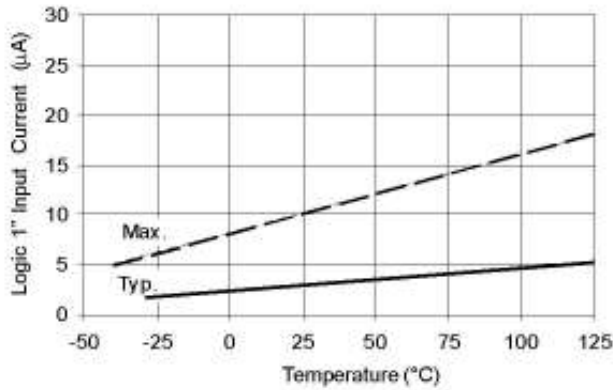
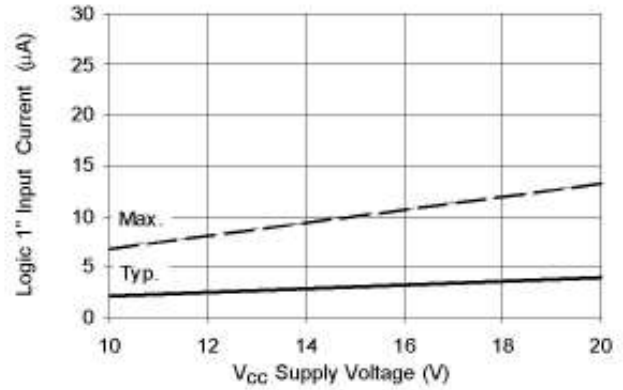


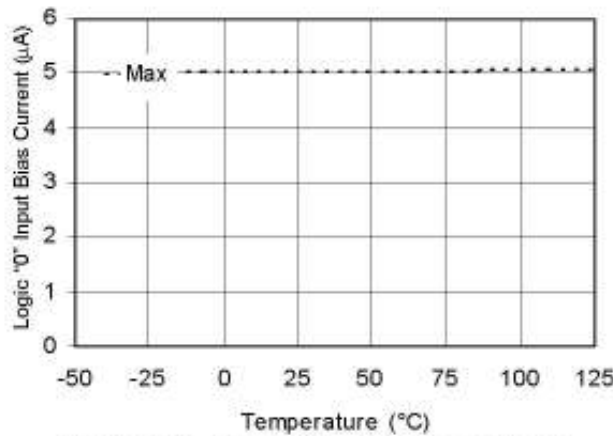
Figure 18B.  $V_{CC}$  Supply Current vs. Voltage



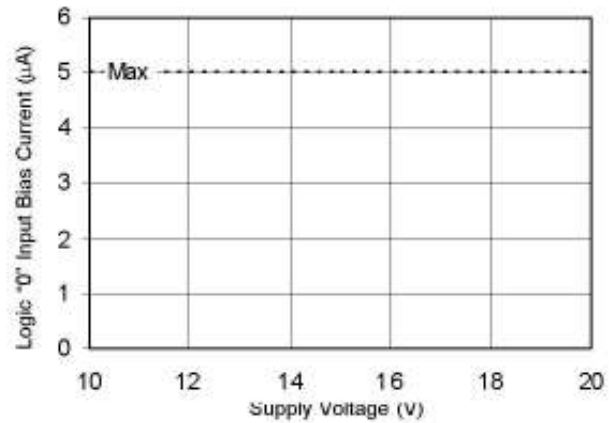
**Figure 19A. Logic "1" Input Current vs. Temperature**



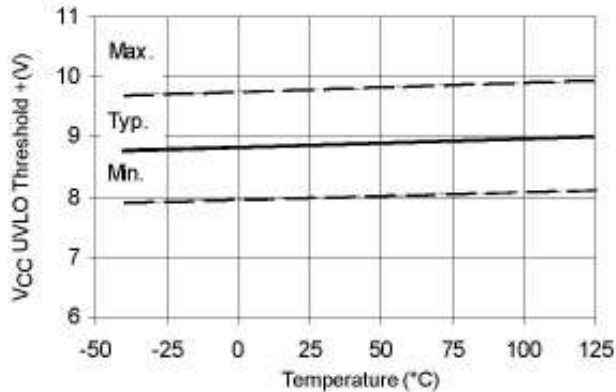
**Figure 19B. Logic "1" Input Current vs. Voltage**



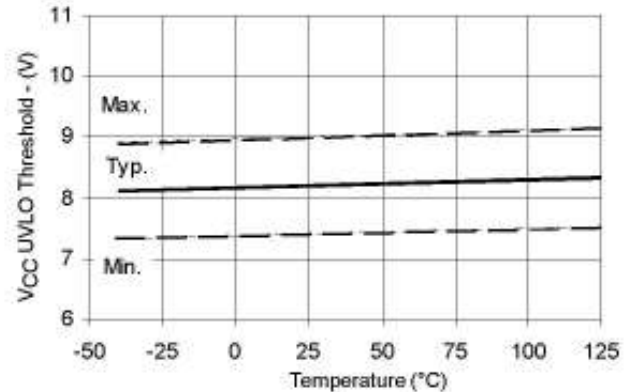
**Figure 20A. Logic "0" Input Bias Current vs. Temperature**



**Figure 20B. Logic "0" Input Bias Current vs. Voltage**

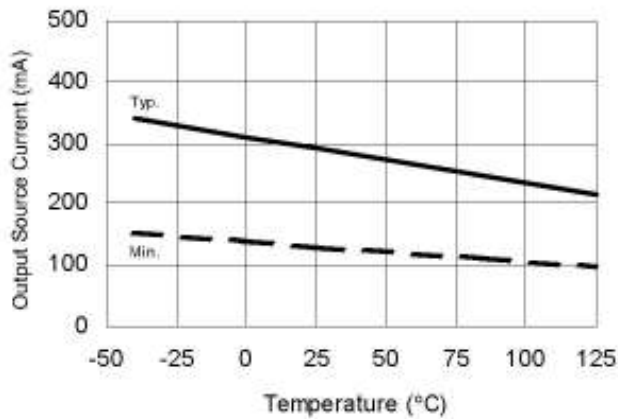


**Figure 21A. V<sub>CC</sub> Undervoltage Threshold(+) vs. Temperature**

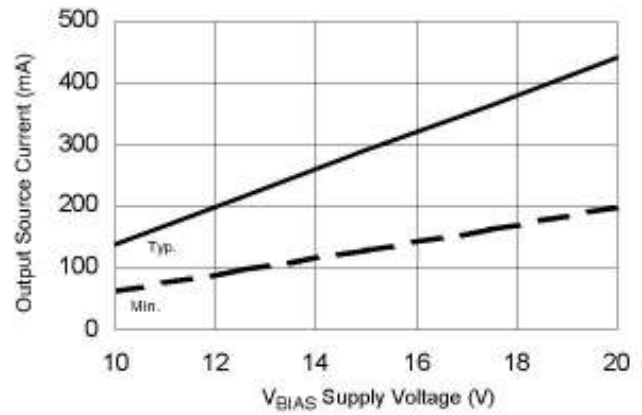


**Figure 21B. V<sub>CC</sub> Undervoltage Threshold(-) vs. Temperature**

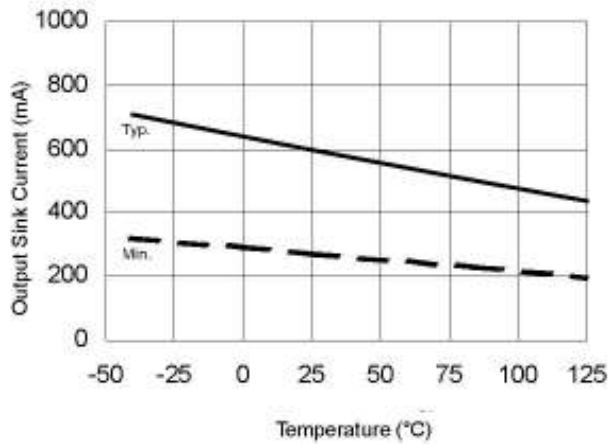
“Not recommended for new designs. For new designs we recommend IRS2005M”



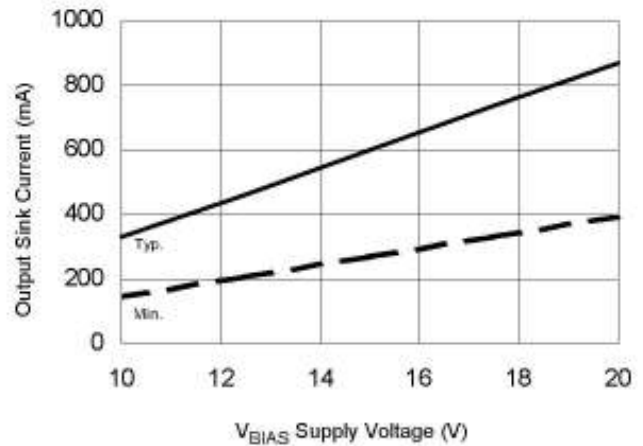
**Figure 22A. Output Source Current vs. Temperature**



**Figure 22B. Output Source Current vs. Supply Voltage**

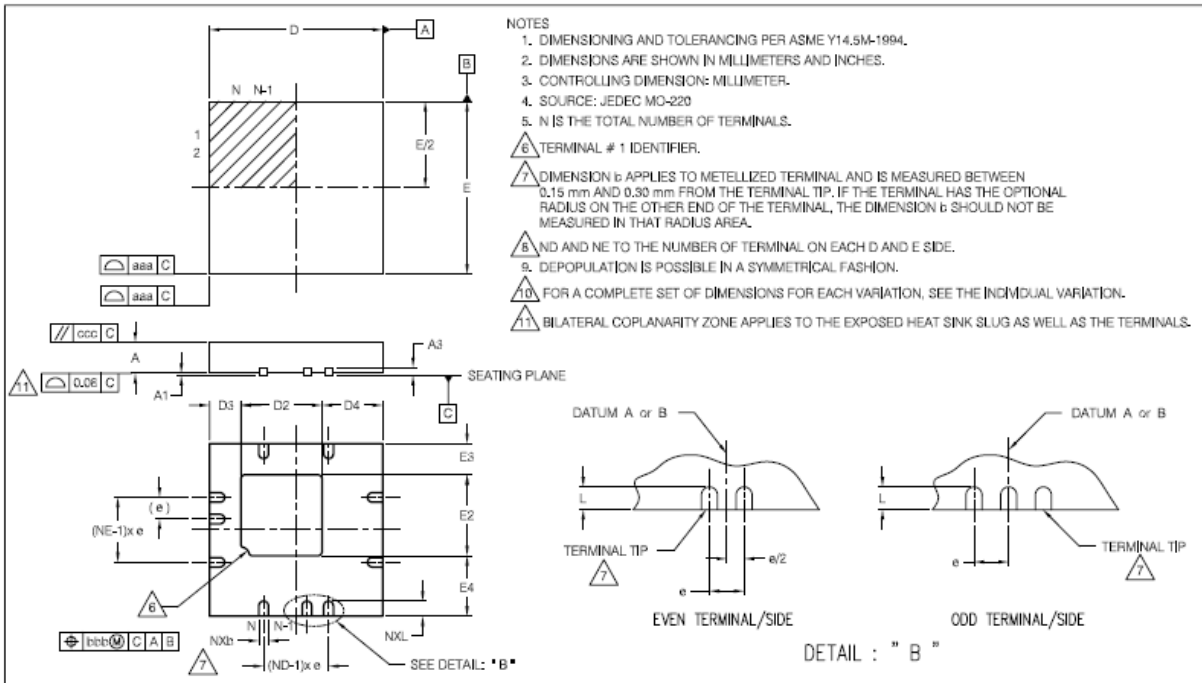


**Figure 23A. Output Sink Current vs. Temperature**



**Figure 23B. Output Sink Current vs. Supply Voltage**

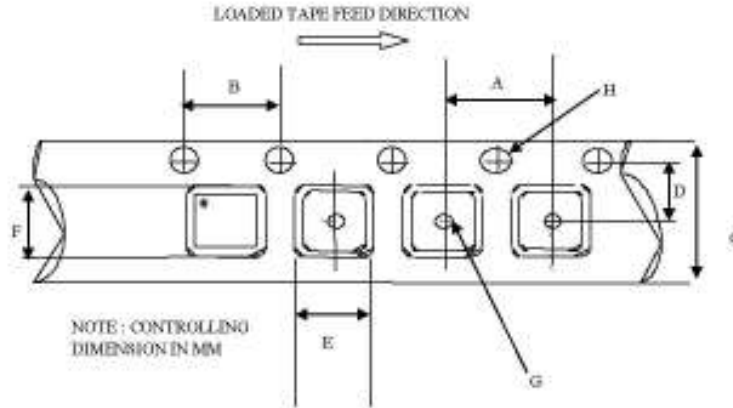
**Package Details: MLPQ 4x4 -14L**



SYMBOL	VGGD-10					
	MILLIMETERS			INCHES		
	MIN	NOM	MAX	MIN	NOM	MAX
A	0.90	0.90	1.00	.032	.035	.039
A1	0.00	0.02	0.05	.000	.0008	.0019
A3	0.20 REF			.008 REF		
b	0.18	0.25	0.30	.007	.010	.012
D2	1.78	1.88	1.98	.070	.074	.078
D3	0.73 REF			.029 REF		
D4	1.40 REF			.055 REF		
D	4.00 BSC			.157 BSC		
E	4.00 BSC			.157 BSC		
E4	1.40 REF			.055 REF		
E3	0.73 REF			.029 REF		
E2	1.78	1.88	1.98	.070	.074	.078
L	0.30	0.40	0.50	.012	.016	.020
e	0.50 PITCH			.020 PITCH		
N	16			16		
ND	4			4		
NE	4			4		
aaa	0.15			.0059		
bbb	0.10			.0039		
ccc	0.10			.0039		
ddd	0.05			.0019		

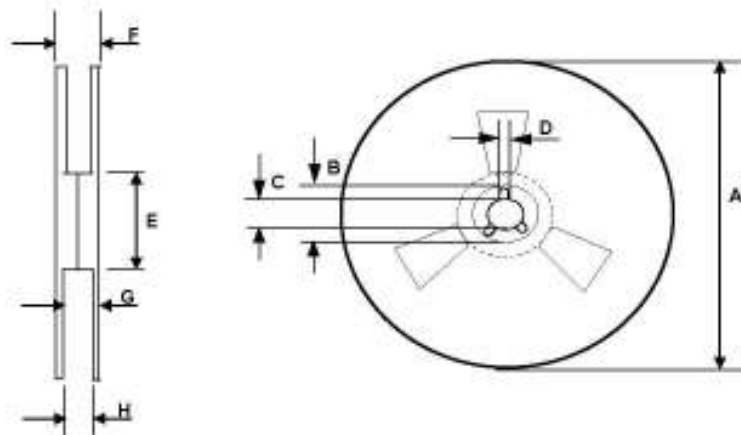
“Not recommended for new designs. For new designs we recommend IRS2005M”

**Tape and Reel Details: MLPQ 4x4 - 14L**



CARRIER TAPE DIMENSION FOR MLPQ4X4V

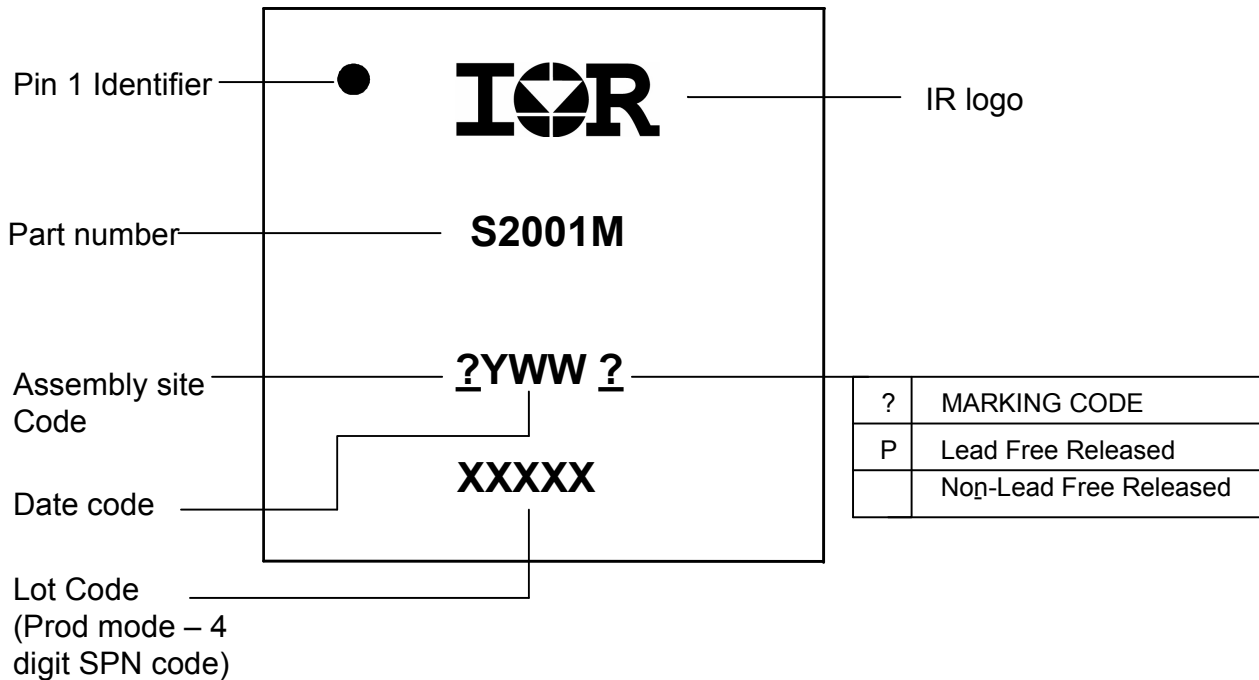
Code	Metric		Imperial	
	Min	Max	Min	Max
A	7.90	8.10	0.311	0.358
B	3.90	4.10	0.154	0.161
C	11.70	12.30	0.461	0.484
D	5.45	5.55	0.215	0.219
E	4.25	4.45	0.168	0.176
F	4.25	4.45	0.168	0.176
G	1.50	n/a	0.059	n/a
H	1.50	1.60	0.059	0.063



REEL DIMENSIONS FOR MLPQ4X4V

Code	Metric		Imperial	
	Min	Max	Min	Max
A	329.60	330.25	12.976	13.001
B	20.95	21.45	0.824	0.844
C	12.80	13.20	0.503	0.519
D	1.95	2.45	0.767	0.096
E	98.00	102.00	3.858	4.015
F	n/a	18.40	n/a	0.724
G	14.50	17.10	0.570	0.673
H	12.40	14.40	0.488	0.566

**Part Marking Information**



**Ordering Information**

Base Part Number	Package Type	Standard Pack		Complete Part Number
		Form	Quantity	
IRS2001	MLPQ 4x4-14L	Tube/Bulk	92	IRS2001MPBF
		Tape and Reel	3,000	IRS2001MTRPBF

The information provided in this document is believed to be accurate and reliable. However, International Rectifier assumes no responsibility for the consequences of the use of this information. International Rectifier assumes no responsibility for any infringement of patents or of other rights of third parties which may result from the use of this information. No license is granted by implication or otherwise under any patent or patent rights of International Rectifier. The specifications mentioned in this document are subject to change without notice. This document supersedes and replaces all information previously supplied.

For technical support, please contact IR's Technical Assistance Center  
<http://www.irf.com/technical-info/>

**WORLD HEADQUARTERS:**  
 233 Kansas St., El Segundo, California 90245  
 Tel: (310) 252-7105

“Not recommended for new designs. For new designs we recommend IRS2005M”

International  
**IR** Rectifier

**IRS2001MPBF**

**Revision History**

Date	Comment
9/15/09	Initial draft converted from SO8 data sheet
06/18/2010	Included Qual Info Page
05/14/2012	lo+/- minspec modification

## Looking for pricing, stock, or lifecycle information?

Click below to explore more details on WIN SOURCE:

 [View IRS2001MPBF](#) on WIN SOURCE

 [Infineon Technologies](#) Information

## Optimize Your Supply Chain with WIN SOURCE Solutions

-  Global Sourcing Solution
-  Obsolete Management
-  Cost Control Management
-  Shortage Management
-  Alternative Solution
-  Excess Inventory Management