



**THE DATASHEET OF  
EVHF500-15-S-00A**





The Future of Analog IC Technology®

# EVHF500-15-S-00A

85V<sub>AC</sub> ~ 265V<sub>AC</sub>/50Hz/60Hz, 12V/1A  
Evaluation Board

## DESCRIPTION

The HF500-15 is a fixed-frequency, current-mode regulator with built-in slope compensation. The HF500-15 combines a 700V MOSFET of high-avalanche ruggedness and a full-featured controller into one chip to create a low-power, offline, flyback, switch-mode power supply.

The EVHF500-15-S-00A evaluation board is designed to demonstrate the capabilities of MPS’s fixed switching frequency, multi-mode flyback regulator. It is designed for general-purpose offline power supplies.

The EVHF500-15-S-00A can meet EN55022 Class B conducted EMI requirements. It has multiple protection functions, including brown in/out, overload protection (OLP), over-voltage protection (OVP), short-circuit protection (SCP), cycle-by-cycle current limiting, and over-temperature protection (OTP).

The EVHF500-15-S-00A specification is listed in the table below.

## ELECTRICAL SPECIFICATION

Parameter	Symbol	Value	Units
Input voltage	V <sub>IN</sub>	90 to 265	V <sub>AC</sub>
Output voltage	V <sub>OUT</sub>	12	V
Output current	I <sub>OUT</sub>	1	A
Output power	P <sub>OUT</sub>	12	W
Efficiency (4 point average)	η	79	%

## FEATURES

- 700V/4.5Ω Integrated MOSFET with High Single-Pulse Avalanche Energy
- Fixed-Frequency, Current-Mode Control Operation with Built-In Slope Compensation
- Frequency Foldback Down to f<sub>OSC(min)</sub> at Light Load
- Burst Mode for Low Standby Power Consumption
- Frequency Jittering for Reduced EMI Signature
- Over-Power Compensation
- Internal High-Voltage Current Source
- VCC Under-Voltage Lockout (UVLO) with Hysteresis
- Programmable Input B/O and Over-Voltage Protection (OVP)
- Overload Protection (OLP) with Programmable Delay
- Latch-Off Protection on TIMER
- Thermal Shutdown (Auto-Restart with Hysteresis)
- Short-Circuit Protection (SCP)
- Programmable Soft Start (SS)

**EVHF500-15-S-00A EVALUATION BOARD**



**TOP VIEW**

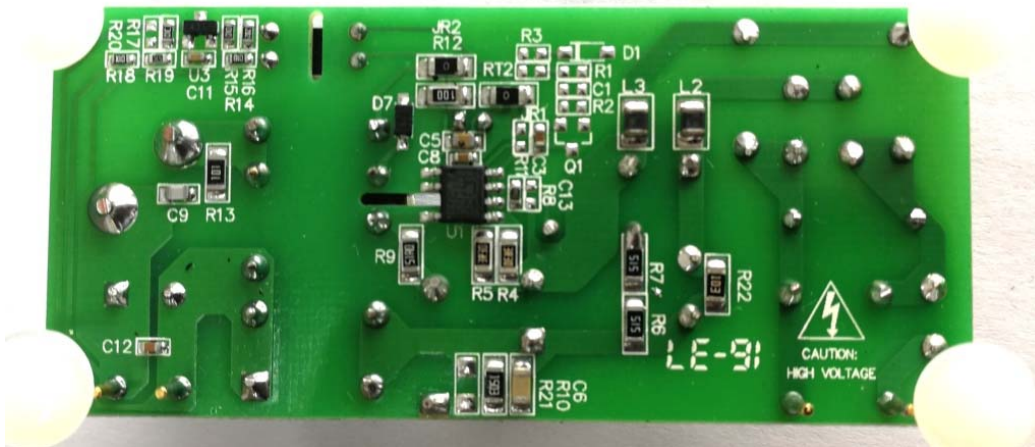

**BOTTOM VIEW**

(L x W x H) 8.0cm x 3.6cm x 2.5cm

Board Number	MPS IC Number
EVHF500-15-S-00A	HF500-15GS



## EVALUATION BOARD SCHEMATIC

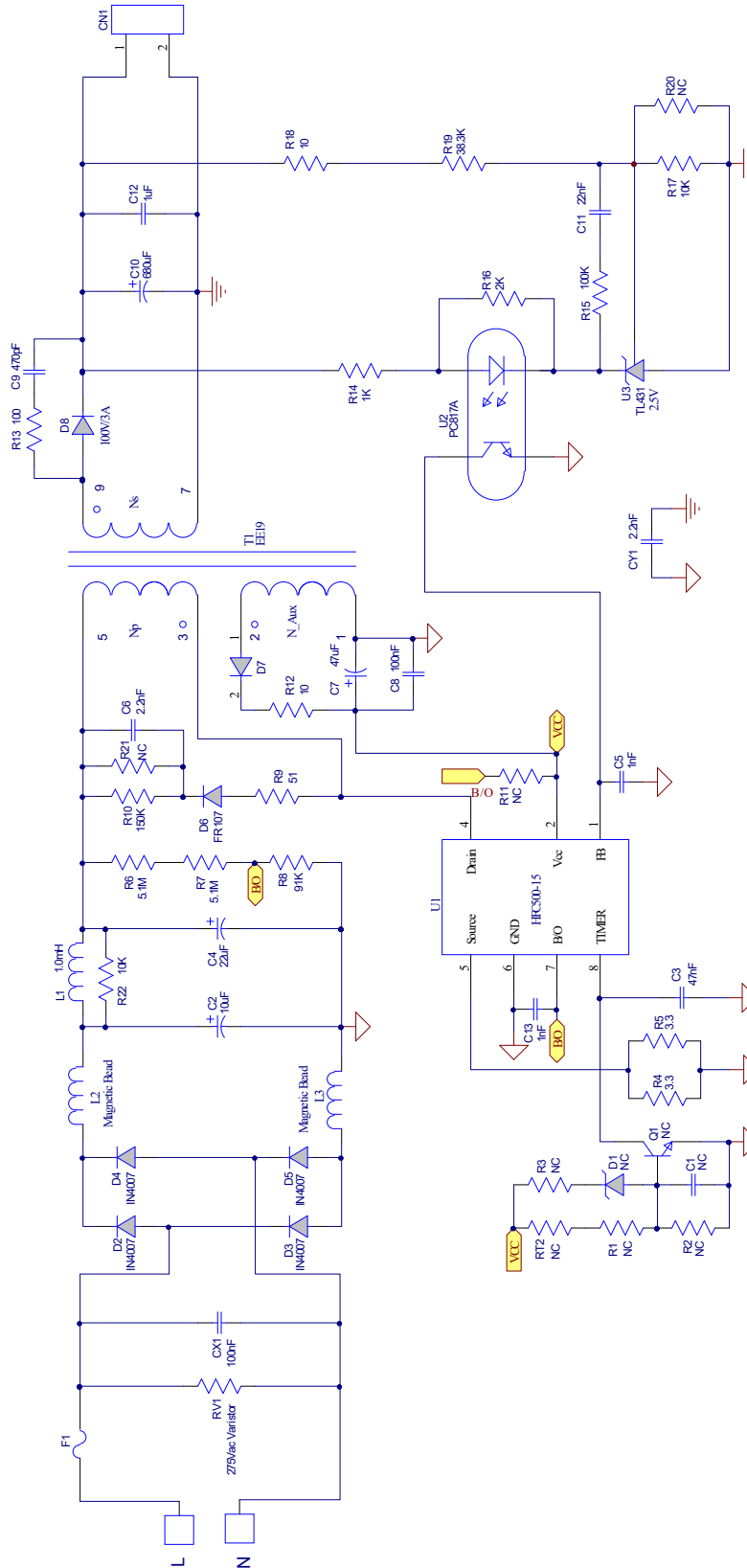

**Figure 1: Schematic**

PCB LAYOUT (SINGLE-SIDED)

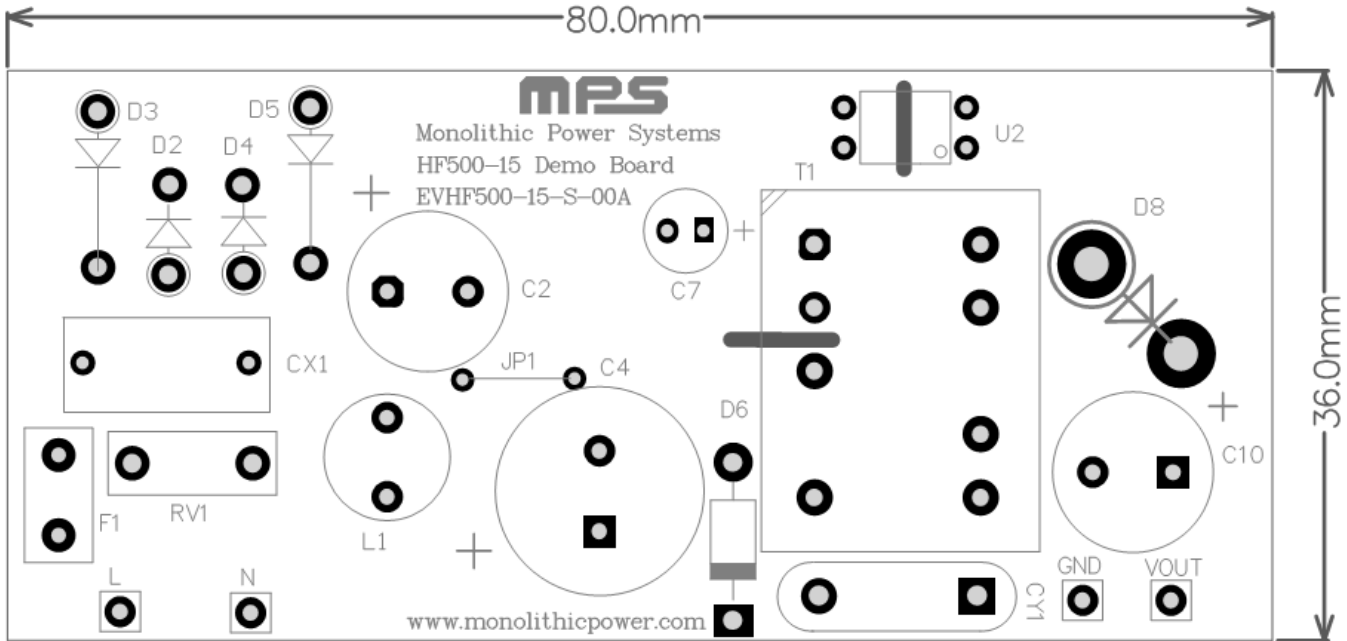

Figure 2: Top Layer

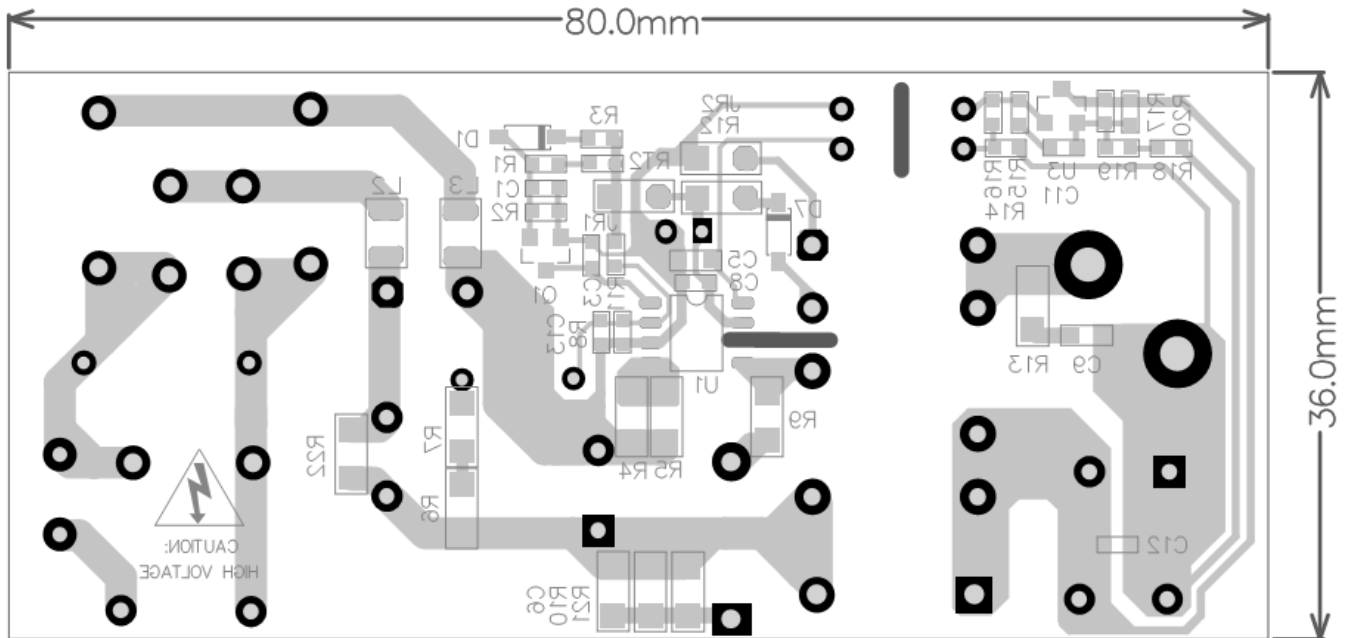

Figure 3: Bottom Layer

**EVHF500-15-S-00A BILL OF MATERIALS**

Qty	RefDes	Value	Description	Package	Manufacturer	Manufacturer_P/N
0	C1	NC	Ceramic Capacitor;25V;X7R;	0603		
1	C2	10 $\mu$ F	Electrolytic Capacitor;400V	DIP	Lelon	RGA100M2G
1	C3	47nF	Ceramic Capacitor;50V;X7R;	0603	muRata	GRM188R71H473KA61D
1	C4	22 $\mu$ F	Electrolytic Capacitor;400V;	DIP	Rubycon	400PX22MEFC12.5X20
1	C5	1nF	Ceramic Capacitor;50V;C0G;	0805	muRata	GRM216R71H102KA01
1	C6	2.2nF	Ceramic Capacitor;630V;X7R;	1206	Murata	GRM31BR72J222KW01L
1	C7	47 $\mu$ F	Electrolytic Capacitor;25V	DIP	Jianghai	CD286-25V47
1	C8	100nF	Ceramic Capacitor;50V;X7R;	0603	muRata	GRM188R71H104KA93D
1	C9	470pF	Ceramic Capacitor;100V;C0G	0805	muRata	GRM2165C2A471JA01D
1	C10	680 $\mu$ F	Electrolytic Capacitor;25V	DIP	Rubycon	25ZLH680MEFC10*16
1	C11	22nF	Ceramic Capacitor;50V;X7R;	0603	muRata	GRM188R71H223KA01D
1	C12	1 $\mu$ F	Ceramic Capacitor;25V	0603	TDK	C1608X7R1E105K
1	CX1	100nF	Capacitor;275V;10%	DIP	Carli	PX104K3IC39L270D9R
1	CY1	2.2nF	Y Capacitor;4000V;10%	DIP	Hongke	JNK12E222MY02N
0	D1	NC	Zener Diode;16V;5mA/500mW;	SOD-123		
4	D2, D3, D4, D5	1N4007	Diode;1000V;1A	DO-41	Diodes	1N4007
1	D6	FR107	Diode;1000V;1A	DO-41	Diodes	FR107
1	D7	BAV21W	Diode;200V;0.2A;	SOD-123	Diodes	BAV21W-7-F
1	D8	BYV28-100	Diode;100V;3A	SOD64	Vishay	BYV28-100
1	F1	SS-5-1A	Fuse;250V;1A	DIP	COOPER	SS-5-1A
1	L1	1.0mH	Inductor;1.0mH;500mA	DIP	Wurth	768772102
2	L2, L3		Magnetic Bead;	SMC	muRata	NFZ2HBM330SN10L
0	Q1	NC	Transistor;25V;0.5A;	SOT-23		
0	R1, R2, R3, R11, R20, R21	NC				
2	R4, R5	3.3	Film Resistor;1%;1/4W;	1206	Yageo	RC1206FR-073R3L
2	R6, R7	5.1M	Film Resistor;5%;1/4W	1206	Yageo	RI1206L515JT
1	R8	91K	Film Resistor;1%	0603	Yageo	RC0603FR-0791KL
1	R9	51	Film Resistor;1%;1/4W	1206	Yageo	RC1206FR-0751RL
1	R10	150K	Film Resistor;1%;1/4W	1206	Yageo	RC1206FR-07150KL
1	R12	10	Film Resistor;5%;1/4W	1206	Yageo	RC1206JR-0710R
1	R13	100	Film Resistor;5%;1/4W	1206	Yageo	RC1206JR-07100RL
1	R14	1K	Film Resistor;5%	0603	Yageo	0603SAJ0102T5E
1	R15	100K	Film Resistor;1%	0603	Yageo	RC0603FR-07100KL
1	R16	2K	Film Resistor;5%	0603	LIZ	,CR0603JA0202G
1	R17	10K	Film Resistor;1%	0603	Yageo	RC0603FR-0710KL
1	R18	10	Film Resistor;1%	0603	Yageo	RC0603FR-0710RL
1	R19	38.3K	Film Resistor;1%	0603	Yageo	RC0603FR-0738K3L
1	R22	10K	Film Resistor;5%;1/4W;	1206	Yageo	RM12JTN103
1	RV1	820512711	Resistor	DIP	Wurth	820512711
1	T1	2.45mH	Flyback Transformer	EE19	Emei	FX0376
1	U1	HF500-15	Multi-mode Flyback Regulator	SOIC8	MPS	HF500-15GS
1	U2	PC817A	Photocoupler;1-Channel	DIP	Yiguang	PC817A
1	U3	TL431	2.5V Voltage Reference	SOT23	Changdian	TL431
2	JR1, JR2	0	Jumper Film Resistor	1206	Yageo	RC1206JR-070RL

## TRANSFORMER SPECIFICATION

### Electrical Diagram

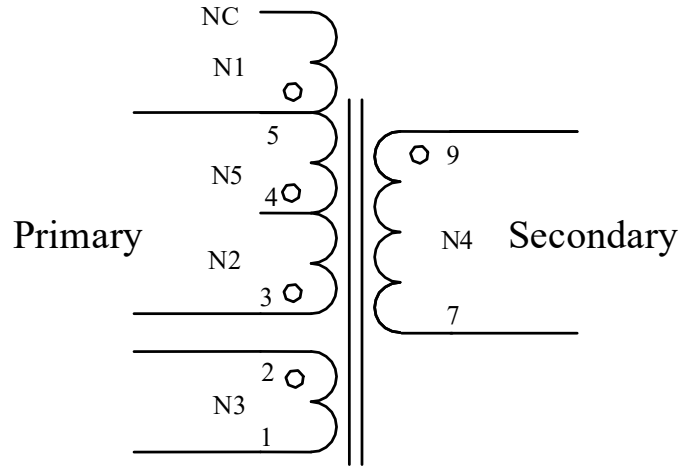

Note:

⊙ : Start Point

Cut 4<sup>th</sup>, 8<sup>th</sup> Pin after Winding

Figure 4:Transformer Electrical Diagram

### Winding Diagram

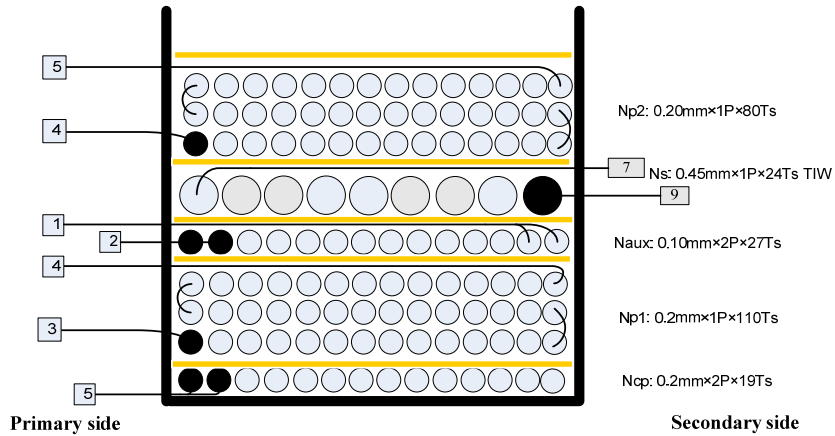

Primary side

Secondary side

Note:

● Start Winding Point

■ Tape

One tape between each winding

Figure 5: Transformer Winding Diagram

**Winding Order**

Tape Layer	Winding #	Start-End	Wire Dia	Turns	Winding	Tube
0	N1	5→NC	0.20mm*2	19	Tightly for each layer	None
1						
1	N2	3→4	0.20mm*1	110	Evenly	None
1	N3	2→1	0.10mm*2	27	Evenly	None
1	N4	9→7	0.45mm*1	24	Evenly	None
1	N5	4→5	0.20mm*1	80	Tightly for each layer	None
1						

**Electrical Specifications**

<b>Electrical Strength</b>	60 second, 60Hz, from PRI. to SEC.	3500VAC
	60 second, 60Hz, from PRI. to CORE.	500VAC
	60 second, 60Hz, from SEC. to CORE.	3500VAC
<b>Primary Inductance</b>	Pins 3 - 5, all other windings open, measured at 60kHz, 0.1 VRMS	2.45mH±10%
<b>Primary Leakage Inductance</b>	Pins 3 - 5 with all other pins shorted, measured at 60kHz, 0.1 VRMS	<120µH±10%

**Materials**

Item	Description
1	Core: EE19
2	Bobbin: EE19 Vertical, 5+5PIN 1 SECT TH, UL94V-0
3	Wire:Φ0.2mm,, 2UEW, Class B
4	Wire:Φ0.1mm,, 2UEW, Class B
5	Triple Insulation Wire: Φ0.45mm TIW
6	Tape: 9.1mm(W)×0.06mm(TH)
7	Varnish: JOHN C. DOLPH CO, BC-346A or equivalent
8	Solder Bar: CHEN NAN: SN99.5/Cu0.5 or equivalent

## CIRCUIT DESCRIPTION

The EVHF500-15-S-00A is a single-stage flyback converter with a multi-mode flyback regulator. The input is universal and the output is 12V/1A. The HF500-15 combines a 700V MOSFET of high-avalanche ruggedness with a full-featured controller into one chip.

F1, RV1, CX1, D2, D3, D4, D5, L2, L3, C2, C4, L1, and R22 compose the input stage. F1 is the fuse and is used to protect the component from failure or some excessive short events. RV1 is the MOV to protect the circuit during the transient over-voltage period. CX1 is the safety X capacitor to restrain differential mode EMI noise. C2, C4, and L1 are also configured for the differential mode EMI filter to suppress conducted EMI. D2, D3, D4 and D5 are configured for the rectifier bridge to convert AC voltage to DC voltage. L2 and L3 are magnetic beads to restrain high-frequency noise for a lower radiated EMI. R22 is the resistor paralleled with L1 to dampen the oscillation between C2, C4, and L1, which also helps improve EMI.

R9, R10, C6, and D6 are configured RCD snubbers to suppress voltage spikes of the MOSFET.

R12, C7, C8, and D7 are used as VCC power supplies.

R6, R7, R8, and C13 are configured as input brown in/out detection circuits. These functions can be disabled by connecting a ~100kΩ resistor between VCC and B/O, which can decrease no-load power consumption.

The circuit consists of D1, R3, C1, and Q1 as the optional OVP circuit. The OVP threshold can be set by this external circuit.

RT2, R1, and R2 can be used as external over-temperature protection circuits if necessary.

The HF500-15 and its peripheral components are configured as a flyback controller circuit. C3 is used to set the jittering period and the clock for protections such as OLP.

R4 and R5 are the current sensing resistors.

T1 is the transformer to transfer power from the primary side to the secondary side. T1 is a key component for the entire circuit to work normal with optimal performance. Therefore, T1 must be designed carefully.

CY1 is safety Y capacitor lowering common-mode noise to ensure a sufficient EMI margin.

D8 is a secondary rectifier. R13/C9 are the snubber to suppress high-voltage spikes on the rectifier.

C10 and C12 are output capacitors to filter the output voltage ripple.

R15 and C11 are configured as the compensation network. R17, R18, R19, and R20 are feedback resistors.

U3 is the voltage reference and U2 is the optocoupler, which is used to transfer the signal from the secondary side to the primary side to regulate the output voltage. The optocoupler working current flows through R14 while the TL431 bias current flows through R16.

## EVB TEST RESULTS

### Performance Data

T<sub>A</sub> = 25°C, unless otherwise noted.

### Efficiency

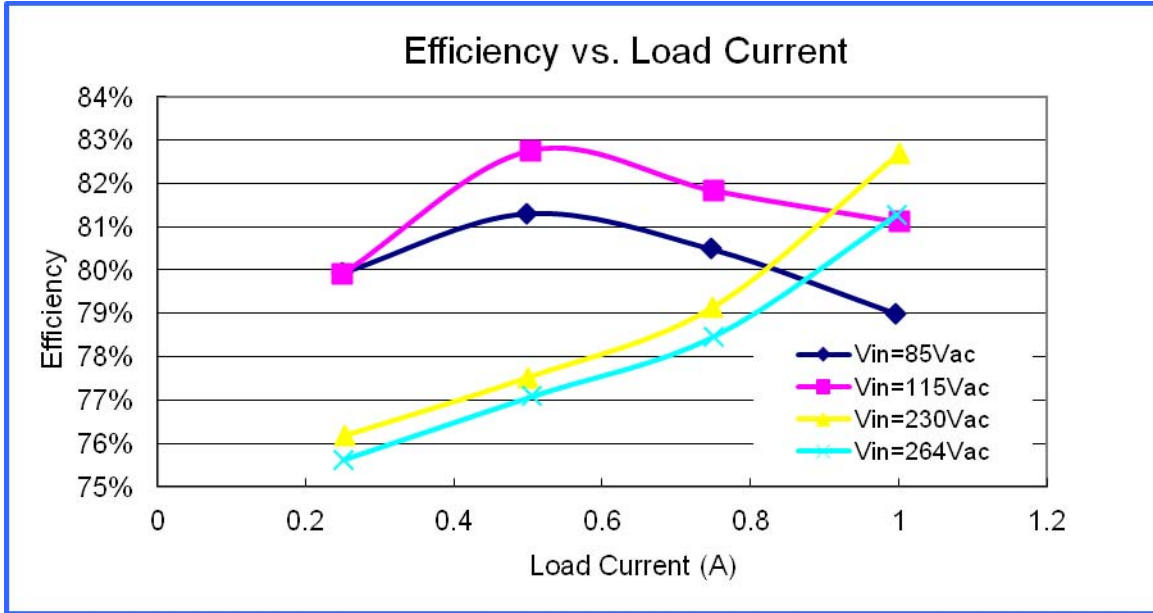

### No Load Consumption

Test Condition	~10M Voltage divider connects with B/O	Pull up B/O by 200kΩ resistor
Vin (VAC)	Pin (mW)	Pin (mW)
85	61.39	63.76
110	57.57	59.17
220	70.7	65.4
265	83.3	69.16

**Conducted EMI Test**

Test with 115V<sub>AC</sub>/230V<sub>AC</sub> input and full load condition

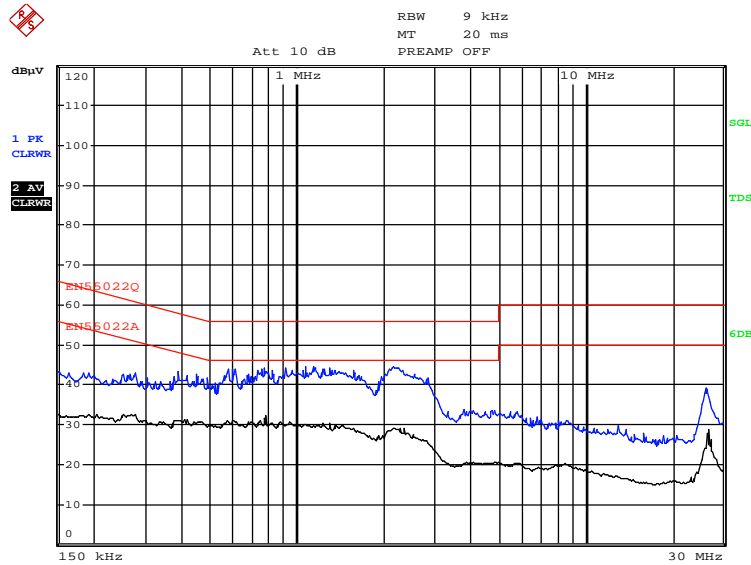

Date: 5.JAN.2015 18:06:31

**115Vac, 60Hz, Maximum Load, L Line, Output GND Floats, EN55022 Class B Limits**

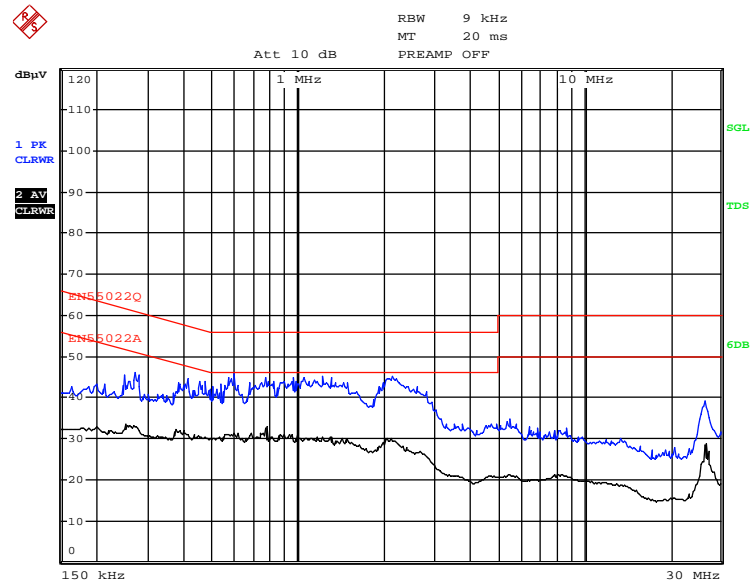

Date: 5.JAN.2015 18:09:36

**115Vac, 60Hz, Maximum Load, N Line, Output GND Floats, EN55022 Class B Limits**

Conducted EMI Test (continued)

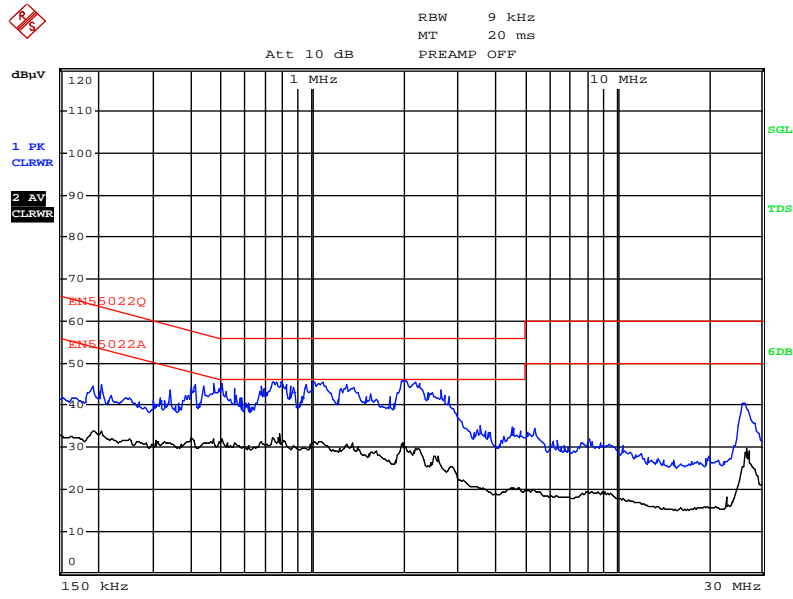

Date: 5.JAN.2015 18:15:36

230Vac, 50Hz, Maximum Load, L Line, Output GND Floats, EN5022 Class B Limits

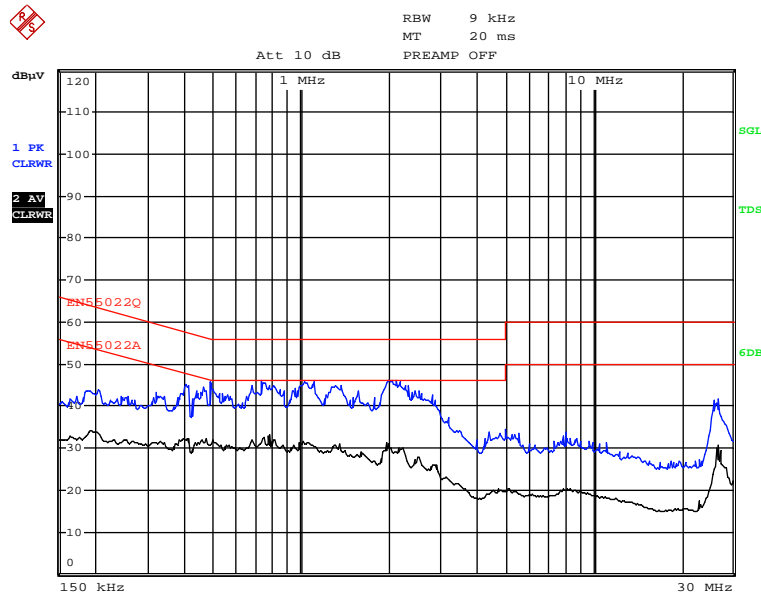

Date: 5.JAN.2015 18:12:37

230Vac, 50Hz, Maximum Load, N Line, Output GND Floats, EN5022 Class B Limits

**Thermal Test**

Test with 85V<sub>AC</sub>/265V<sub>AC</sub> input and full load condition. PCB layout with 1Oz copper. T<sub>A</sub> = 28°C.

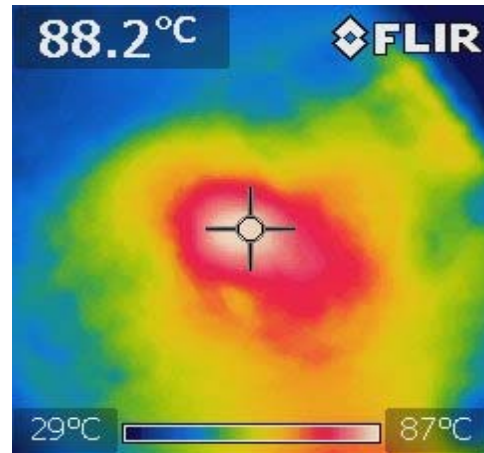
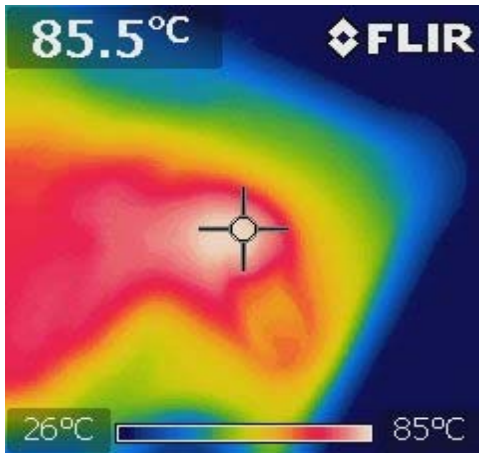

**V<sub>in</sub>=85Vac, Thermal Performance of Rectifier (Left) and HF500-15 (Right)**

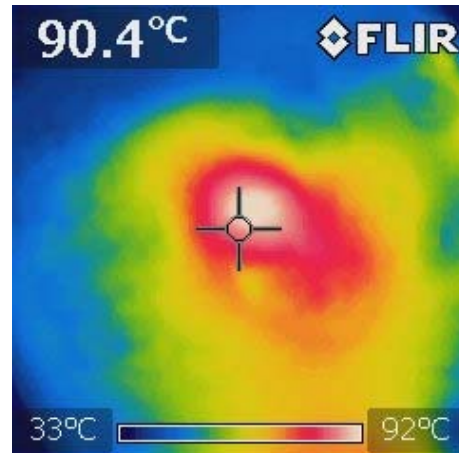
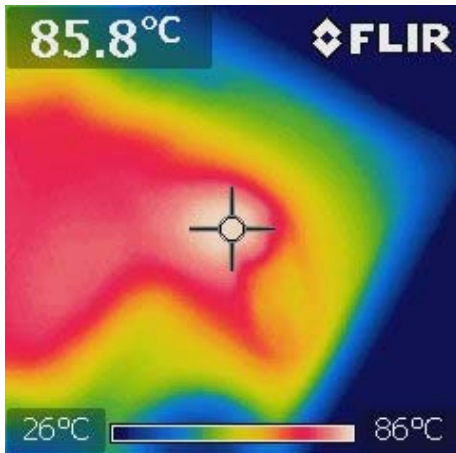

**V<sub>in</sub>=265Vac, Thermal Performance of Rectifier (Left) and HF500-15 (Right)**

### Quick Start Guide

1. Preset the power supply to  $85V_{AC} \leq V_{IN} \leq 265V_{AC}$ .
2. Turn the power supply off.
3. Connect the line and neutral terminals of the power supply output to the L and N ports . For three-wire input applications, connect the OUTPUT GND connected to Earth.
4. Connect the load to:
  - a. Positive (+): VOUT
  - b. Negative (-): GND
5. Turn the power supply on after making the connections.

**NOTICE:** The information in this document is subject to change without notice. Please contact MPS for current specifications. Users should warrant and guarantee that third party Intellectual Property rights are not infringed upon when integrating MPS products into any application. MPS will not assume any legal responsibility for any said applications.

## Looking for pricing, stock, or lifecycle information?

Click below to explore more details on WIN SOURCE:

- ⊖ [View EVHF500-15-S-00A on WIN SOURCE](#)
- ⊖ [Monolithic Power Systems Inc. Information](#)

## Optimize Your Supply Chain with WIN SOURCE Solutions

- ✓ Global Sourcing Solution
- ✓ Obsolete Management
- ✓ Cost Control Management
- ✓ Shortage Management
- ✓ Alternative Solution
- ✓ Excess Inventory Management