

# CBTL06DP212

## High-performance DisplayPort Gen2 2 : 1 multiplexer

Rev. 2 — 3 November 2011

Product data sheet

### 1. General description

---

CBTL06DP212 is a high performance multi-channel Generation 2 multiplexer meant for DisplayPort (DP) v1.2, v1.1a or Embedded DisplayPort applications operating at data rate of 1.62 Gbit/s, 2.7 Gbit/s or 5.4 Gbit/s. It is designed using NXP proprietary high-bandwidth pass-gate technology and it can be used for 1 : 2 switching or 2 : 1 multiplexing of four high-speed differential AC-coupled DP channels. Further, it is capable of switching/multiplexing of Hot Plug Detect (HPD) signal as well as Auxiliary (AUX) and Display Data Channel (DDC) signals. In order to support GPUs/CPU's that have dedicated AUX and DDC I/Os, CBTL06DP212 provides an additional level of multiplexing of AUX and DDC signals delivering true flexibility and choice.

A typical application of CBTL06DP212 is on motherboards where one of two GPU DisplayPort sources needs to be selected to connect to a DisplayPort sink device or connector. A controller chip selects which path to use by setting a select signal HIGH or LOW. Due to the bidirectional nature of the signal paths, CBTL06DP212 can also be used in the reverse topology, e.g., to connect one display source device to one of two display sink devices or connectors.

### 2. Features and benefits

---

- 1 : 2 switching or 2 : 1 multiplexing of DisplayPort (v1.2 - 5.4 Gbit/s) signals
  - ◆ 4 high-speed differential channels with 2 : 1 multiplexing/switching for DisplayPort main link signals
  - ◆ 1 channel with 4 : 1 multiplexing/switching for AUX or DDC signals
  - ◆ 1 channel with 2 : 1 multiplexing/switching for HPD signal
- High-bandwidth: 5 GHz at -3 dB
- Low insertion loss:
  - ◆ -0.5 dB at 100 MHz
  - ◆ -3 dB at 5 GHz
- Low crosstalk: -35 dB at 3 GHz
- Low off-state isolation: -30 dB at 3 GHz
- Low return loss: -8 dB at 3 GHz
- Very low intra-pair skew (5 ps typical)
- Very low inter-pair skew (< 80 ps)
- Switch/multiplexer position select CMOS input
- DDC and AUX ports tolerant to being pulled to +5 V via 2.2 kΩ resistor
  - ◆ Supports HDMI/DVI incorrect dongle connection
- Single 3.3 V power supply
- Operation current of 2 mA typical



- ESD 8 kV HBM, 1 kV CDM
- ESD 2 kV HBM, 500 V CDM for control pins
- Available in 5 mm × 5 mm, 0.5 mm ball pitch TFBGA48 package

### 3. Applications

- Motherboard applications requiring DisplayPort and PCI Express switching/multiplexing
- Docking stations
- Notebook computers
- Chip sets requiring flexible allocation of PCI Express or DisplayPort I/O pins to board connectors

### 4. Ordering information

Table 1. Ordering information

Type number	Solder process	Package		
		Name	Description	Version
CBTL06DP212EE	Pb-free (SnAgCu solder compound)	TFBGA48	plastic thin fine-pitch ball grid array package; 48 balls; body 5 × 5 × 0.8 mm <sup>[1]</sup>	SOT918-1

[1] Total height including solder balls after printed circuit board mounting = 1.15 mm maximum.

### 5. Marking

Table 2. Package marking

Line	Marking	Description
A	6D212 <sup>[1]</sup>	basic type number
B	xxxxxxx	diffusion lot number
C	ZPGyyww	manufacturing code: Z = diffusion site P = assembly site G = lead-free yy = year code ww = week code

[1] Industrial temperature range.

**6. Functional diagram**

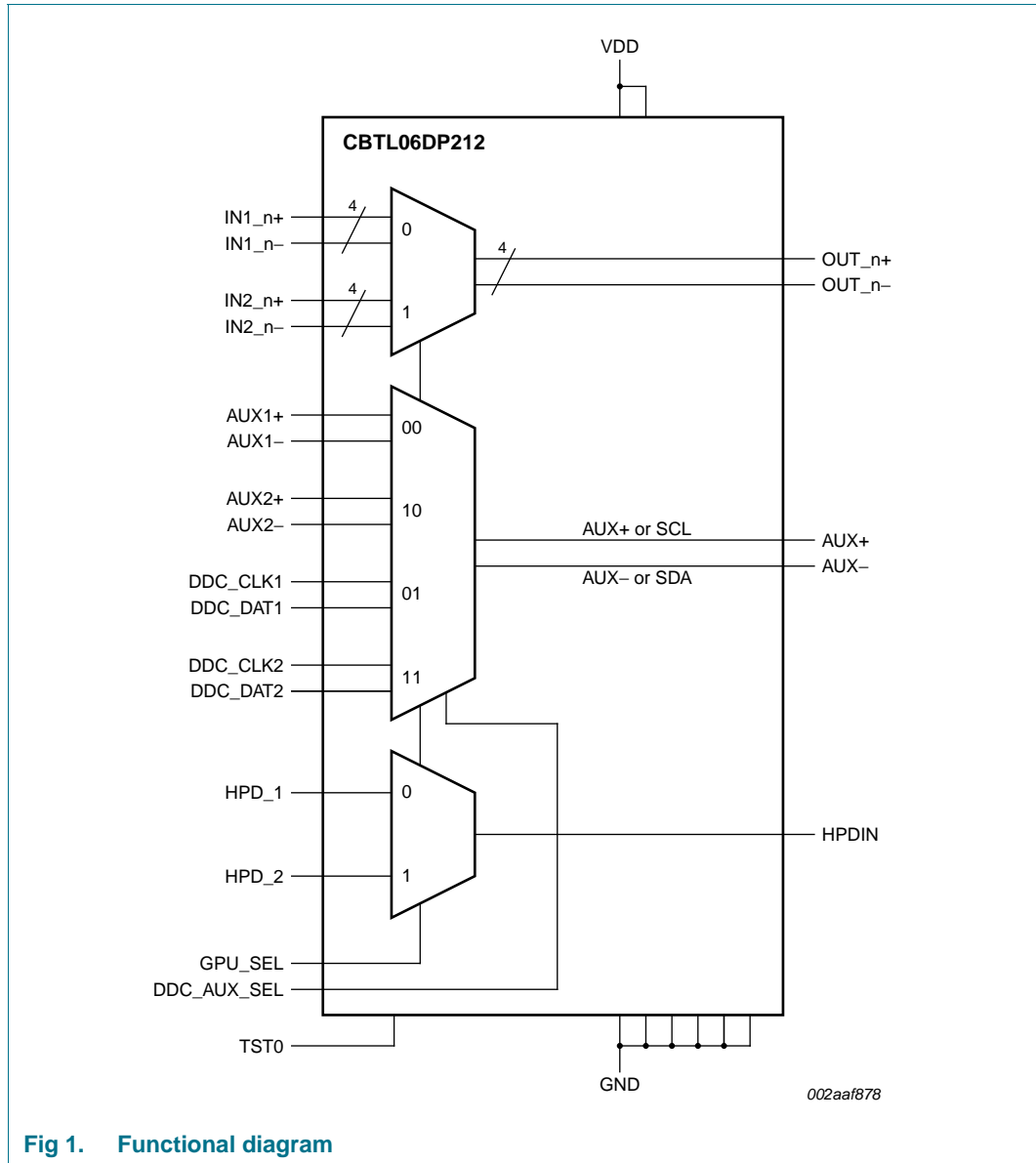

## 7. Pinning information

### 7.1 Pinning

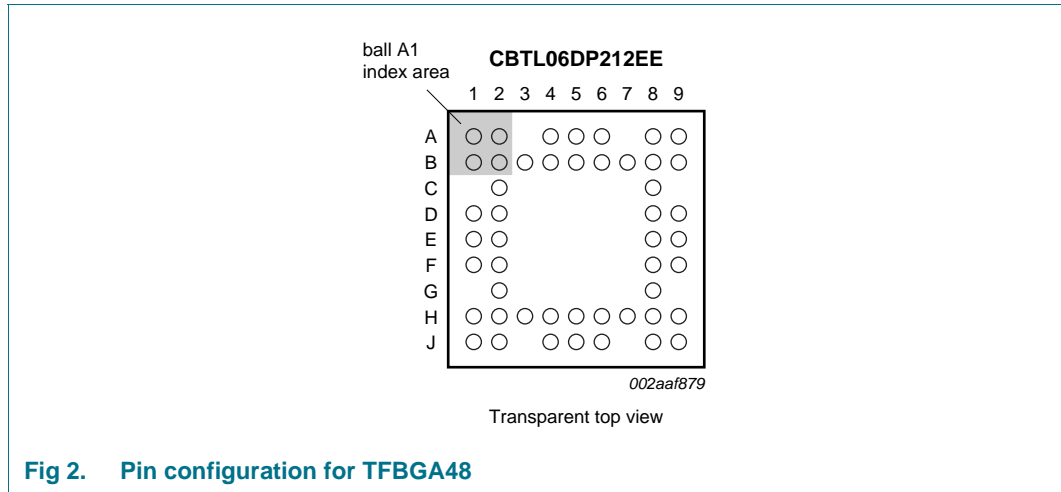

	1	2	3	4	5	6	7	8	9
A	GPU_SEL	VDD		IN1_0-	IN1_1-	IN1_2-		IN1_3+	IN1_3-
B	OUT_0-	OUT_0+	GND	IN1_0+	IN1_1+	IN1_2+	TST0	IN2_0+	IN2_0-
C		DDC_AUX_SEL						GND	
D	OUT_1-	OUT_1+						IN2_1+	IN2_1-
E	OUT_2-	OUT_2+						IN2_2+	IN2_2-
F	OUT_3-	OUT_3+						IN2_3+	IN2_3-
G		GND						GND	
H	AUX-	AUX+	HPD_2	GND	DDC_CLK2	AUX2+	GND	DDC_CLK1	AUX1+
J	HPDIN	HPD_1		VDD	DDC_DAT2	AUX2-		DDC_DAT1	AUX1-

002aaf943

Transparent top view

**Fig 3. Ball mapping**

## 7.2 Pin description

**Table 3. Pin description**

Symbol	Ball	Type	Description
GPU_SEL	A1	3.3 V CMOS single-ended input	Selects between two multiplexer/switch paths. When HIGH, path 2 left-side is connected to its corresponding right-side I/O. When LOW, path 1 left-side is connected to its corresponding right-side I/O.
DDC_AUX_SEL	C2	3.3 V CMOS single-ended input	Selects between DDC and AUX paths. When HIGH, the CLK and DAT I/Os are connected to their respective DDCOUT terminals. When LOW, the AUX+ and AUX- I/Os are connected to their respective DDCOUT terminals.
TST0	B7	3.3 V CMOS single-ended input	Test pin for NXP use only. Should be tied to VDD in normal operation.
IN1_0+	B4	differential I/O	Four high-speed differential pairs for DisplayPort or PCI Express signals, path 1, left-side.
IN1_0-	A4	differential I/O	
IN1_1+	B5	differential I/O	
IN1_1-	A5	differential I/O	
IN1_2+	B6	differential I/O	
IN1_2-	A6	differential I/O	
IN1_3+	A8	differential I/O	
IN1_3-	A9	differential I/O	
IN2_0+	B8	differential I/O	Four high-speed differential pairs for DisplayPort or PCI Express signals, path 2, left-side.
IN2_0-	B9	differential I/O	
IN2_1+	D8	differential I/O	
IN2_1-	D9	differential I/O	
IN2_2+	E8	differential I/O	
IN2_2-	E9	differential I/O	
IN2_3+	F8	differential I/O	
IN2_3-	F9	differential I/O	
OUT_0+	B2	differential I/O	Four high-speed differential pairs for DisplayPort or PCI Express signals, right-side.
OUT_0-	B1	differential I/O	
OUT_1+	D2	differential I/O	
OUT_1-	D1	differential I/O	
OUT_2+	E2	differential I/O	
OUT_2-	E1	differential I/O	
OUT_3+	F2	differential I/O	
OUT_3-	F1	differential I/O	
AUX1+	H9	differential I/O	High-speed differential pair for AUX signals, path 1, left-side.
AUX1-	J9	differential I/O	
AUX2+	H6	differential I/O	High-speed differential pair for AUX signals, path 2, left-side.
AUX2-	J6	differential I/O	
DDC_CLK1	H8	differential I/O	Pair of single-ended terminals for DDC clock and data signals, path 1, left-side.
DDC_DAT1	J8	differential I/O	

Table 3. Pin description ...continued

Symbol	Ball	Type	Description
DDC_CLK2	H5	differential I/O	Pair of single-ended terminals for DDC clock and data signals, path 2, left-side.
DDC_DAT2	J5	differential I/O	
AUX+	H2	differential I/O	High-speed differential pair for AUX or single-ended DDC signals, right-side.
AUX-	H1	differential I/O	
HPD_1	J2	single-ended I/O	Single ended channel for the HPD signal, path 1, left-side.
HPD_2	H3	single-ended I/O	Single ended channel for the HPD signal, path 2, left-side.
HPDIN	J1	single-ended I/O	Single ended channel for the HPD signal, right-side.
VDD	A2, J4	power supply	3.3 V power supply.
GND	B3, C8, G2, G8, H4, H7	ground	Ground.

## 8. Functional description

Refer to [Figure 1 “Functional diagram”](#).

The CBTL06DP212 uses a 3.3 V power supply. All main signal paths are implemented using high-bandwidth pass-gate technology and are bidirectional. No clock or reset signal is needed for the multiplexer to function.

The switch position for the main channels is selected using the select signal GPU\_SEL. Additionally, the signal DDC\_AUX\_SEL selects between AUX and DDC positions for the DDC / AUX channel. The detailed operation is described in [Section 8.1](#).

### 8.1 Multiplexer/switch select functions

The internal multiplexer switch position is controlled by two logic inputs GPU\_SEL and DDC\_AUX\_SEL as described below.

Table 4. Multiplexer/switch select control for IN<sub>n</sub> and OUT<sub>n</sub> channels

GPU_SEL	IN1_n	IN2_n
0	active; connected to OUT_n	high-impedance
1	high-impedance	active; connected to OUT_n

Table 5. Multiplexer/switch select control for HPD channel

GPU_SEL	HPD_1	HPD_2
0	active; connected to HPDIN	high-impedance
1	high-impedance	active; connected to HPDIN

**Table 6. Multiplexer/switch select control for DDC and AUX channels**

DDC_AUX_SEL	GPU_SEL	AUX1	AUX2	DDC_CLK1, DDC_DAT1	DDC_CLK2, DDC_DAT2
0	0	active; connected to AUX	high-impedance	high-impedance	high-impedance
0	1	high-impedance	active; connected to AUX	high-impedance	high-impedance
1	0	high-impedance	high-impedance	active; connected to AUX	high-impedance
1	1	high-impedance	high-impedance	high-impedance	active; connected to AUX

## 9. Limiting values

**Table 7. Limiting values**

In accordance with the Absolute Maximum Rating System (IEC 60134).

Symbol	Parameter	Conditions	Min	Max	Unit	
$V_{DD}$	supply voltage		-0.3	+5	V	
$T_{case}$	case temperature		-40	+85	°C	
$V_{ESD}$	electrostatic discharge voltage	HBM	[1]	-	8000	V
		HBM; CMOS inputs	[1]	-	2000	V
		CDM	[2]	-	1000	V
		CDM; CMOS inputs	[2]	-	500	V

[1] Human Body Model: ANSI/EOS/ESD-S5.1-1994, standard for ESD sensitivity testing, Human Body Model - Component level; Electrostatic Discharge Association, Rome, NY, USA.

[2] Charged Device Model: ANSI/EOS/ESD-S5.3-1-1999, standard for ESD sensitivity testing, Charged Device Model - Component level; Electrostatic Discharge Association, Rome, NY, USA.

## 10. Recommended operating conditions

**Table 8. Recommended operating conditions**

Symbol	Parameter	Conditions	Min	Typ	Max	Unit	
$V_{DD}$	supply voltage		3.0	3.3	3.6	V	
$V_I$	input voltage	CMOS inputs	-0.3	-	$V_{DD} + 0.3$	V	
		HPD inputs	[1]	-0.3	-	$V_{DD} + 0.3$	V
		DDC/AUX inputs	[2]	-0.3	-	$V_{DD} + 0.3$	V
		other inputs		-0.3	-	+2.6	V
$T_{amb}$	ambient temperature	operating in free air	-40	-	+85	°C	

[1] HPD input is tolerant to 5 V input, provided a 1 k $\Omega$  series resistor between the voltage source and the pin is placed in series. See [Section 12.1 "Special considerations"](#).

[2] DDC/AUX inputs are tolerant to 5 V input, provided a 2.2 k $\Omega$  series resistor between the voltage source and the pin is placed in series. See [Section 12.1 "Special considerations"](#).

## 11. Characteristics

### 11.1 General characteristics

Table 9. General characteristics

Symbol	Parameter	Conditions	Min	Typ	Max	Unit
$I_{DD}$	supply current	$V_{DD} = 3.3\text{ V}$	-	2	3	mA
$P_{cons}$	power consumption	$V_{DD} = 3.3\text{ V}$	-	-	10	mW
$t_{startup}$	start-up time	supply voltage valid to channel specified operating characteristics	-	-	10	$\mu\text{s}$
$t_{rcfg}$	reconfiguration time	GPU_SEL or DDC_AUX_SEL state change to channel specified operating characteristics	-	-	1	$\mu\text{s}$

### 11.2 DisplayPort channel characteristics

Table 10. DisplayPort channel characteristics

Symbol	Parameter	Conditions	Min	Typ	Max	Unit
$V_I$	input voltage		-0.3	-	+2.6	V
$V_{IC}$	common-mode input voltage		0	-	2.0	V
$V_{ID}$	differential input voltage	peak-to-peak	-	-	+1.2	V
$R_{on}$	ON-state resistance	$V_{DD} = 3.3\text{ V}$ ; $V_I = 2\text{ V}$ ; $I_I = 20\text{ mA}$	-	6.5	-	$\Omega$
DDIL	differential insertion loss	channel is ON; $f \leq 100\text{ MHz}$	-	-0.5	-	dB
		channel is ON; $f = 3.0\text{ GHz}$	-	-2.5	-	dB
		channel is OFF; $f \leq 3.0\text{ GHz}$	-	-30	-	dB
DDRL	differential return loss	$f = 100\text{ MHz}$	-	-25	-	dB
		$f = 3.0\text{ GHz}$	-	-8	-	dB
DDNEXT	differential near-end crosstalk	adjacent channels are ON				
		$f = 100\text{ MHz}$	-	-65	-	dB
		$f = 3.0\text{ GHz}$	-	-35	-	dB
B	bandwidth	-3.0 dB intercept	-	5	-	GHz
$t_{PD}$	propagation delay	from left-side port to right-side port or vice versa	-	80	-	ps
$t_{sk(dif)}$	differential skew time	intra-pair	-	5	-	ps
$t_{sk}$	skew time	inter-pair	-	-	80	ps

### 11.3 AUX and DDC ports

**Table 11. AUX and DDC port characteristics**

Symbol	Parameter	Conditions	Min	Typ	Max	Unit
$V_I$	input voltage		-0.3	-	$V_{DD} + 0.3$	V
$V_O$	output voltage	no load	-	-	$V_{DD}$	V
$V_{IC}$	common-mode input voltage	AUX	0	-	2.0	V
$V_{ID}$	differential input voltage	AUX	-	-	+1.4	V
$t_{PD}$	propagation delay	from left-side port to right-side port or vice versa	[1]	-	80	ps

[1] Time from DDC/AUX input changing state to AUX output changing state. Includes DDC/AUX rise/fall time.

### 11.4 HPDIN input, HPD\_x outputs

**Table 12. HPD input and output characteristics**

Symbol	Parameter	Conditions	Min	Typ	Max	Unit
$V_I$	input voltage		-0.3	-	$V_{DD} + 0.3$	V
$V_O$	output voltage	no load	-	-	$V_{DD}$	V
$t_{PD}$	propagation delay	from HPDIN to HPD_x or vice versa	[1]	-	80	ps

[1] Time from HPDIN changing state to HPD\_x changing state. Includes HPD rise/fall time.

### 11.5 GPU\_SEL and DDC\_AUX\_SEL inputs

**Table 13. GPU\_SEL and DDC\_AUX\_SEL input characteristics**

Symbol	Parameter	Conditions	Min	Typ	Max	Unit
$V_{IH}$	HIGH-level input voltage		2.0	-	-	V
$V_{IL}$	LOW-level input voltage		-	-	0.8	V
$I_{LI}$	input leakage current	$V_{DD} = 3.6\text{ V}; 0.3\text{ V} \leq V_I \leq 3.9\text{ V}$	-	-	10	$\mu\text{A}$

**12. Application information**

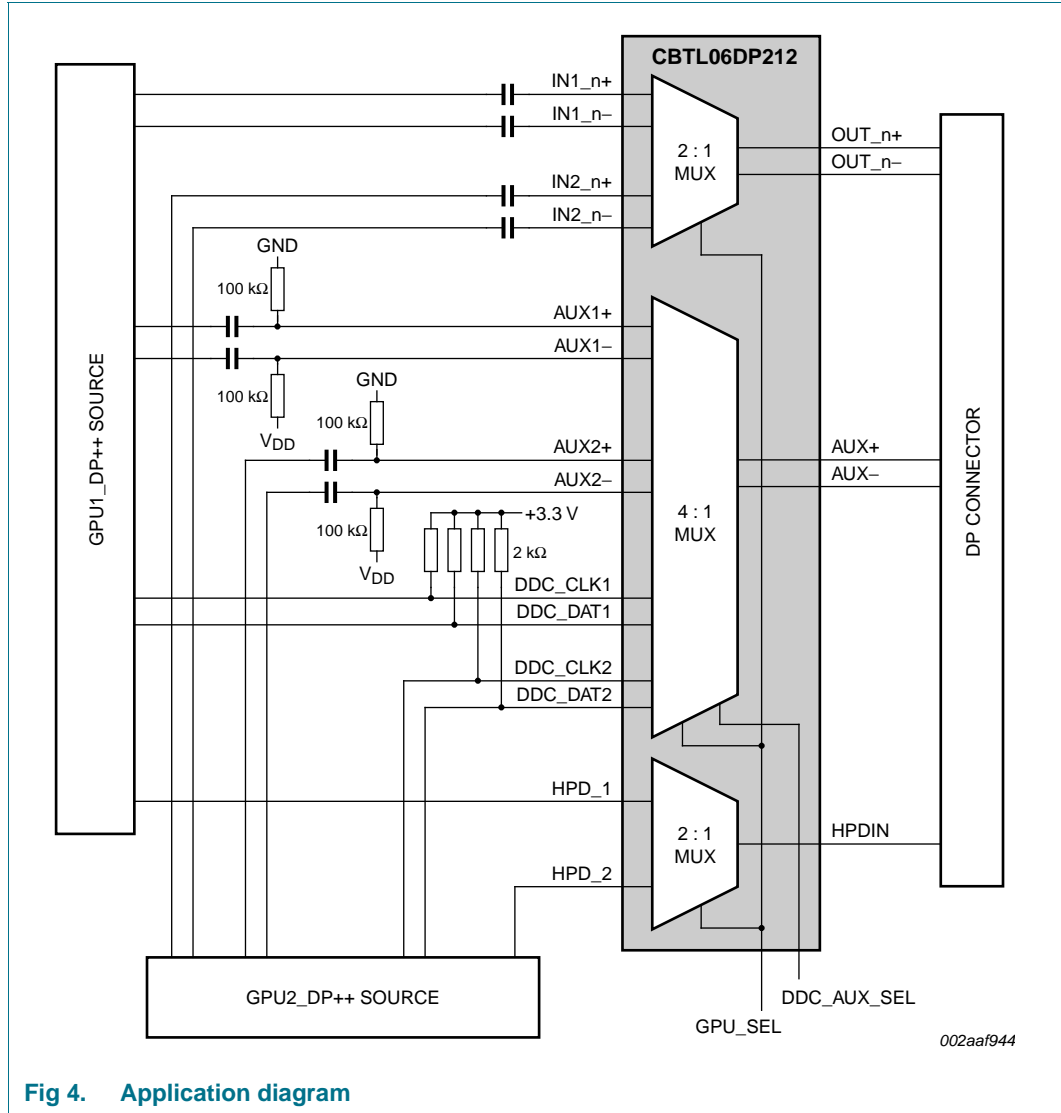

**Fig 4. Application diagram**

**12.1 Special considerations**

Certain cable or dongle misplug scenarios make it possible for a 5 V input condition to occur on pins AUX+ and AUX-, as well as HPDIN. When AUX+ and AUX- are connected through a minimum of 2.2 kΩ each, the CBTL06DP212 will sink current but will not be damaged. Similarly, HPDIN may be connected to 5 V via at least a 1 kΩ resistor. (Correct functional operation to specification is not expected in these scenarios.) The latter also prevents the HPDIN input from loading down the system HPD signal when power to the CBTL06DP212 is off.

### 13. Package outline

TFBGA48: plastic thin fine-pitch ball grid array package; 48 balls; body 5 x 5 x 0.8 mm

SOT918-1

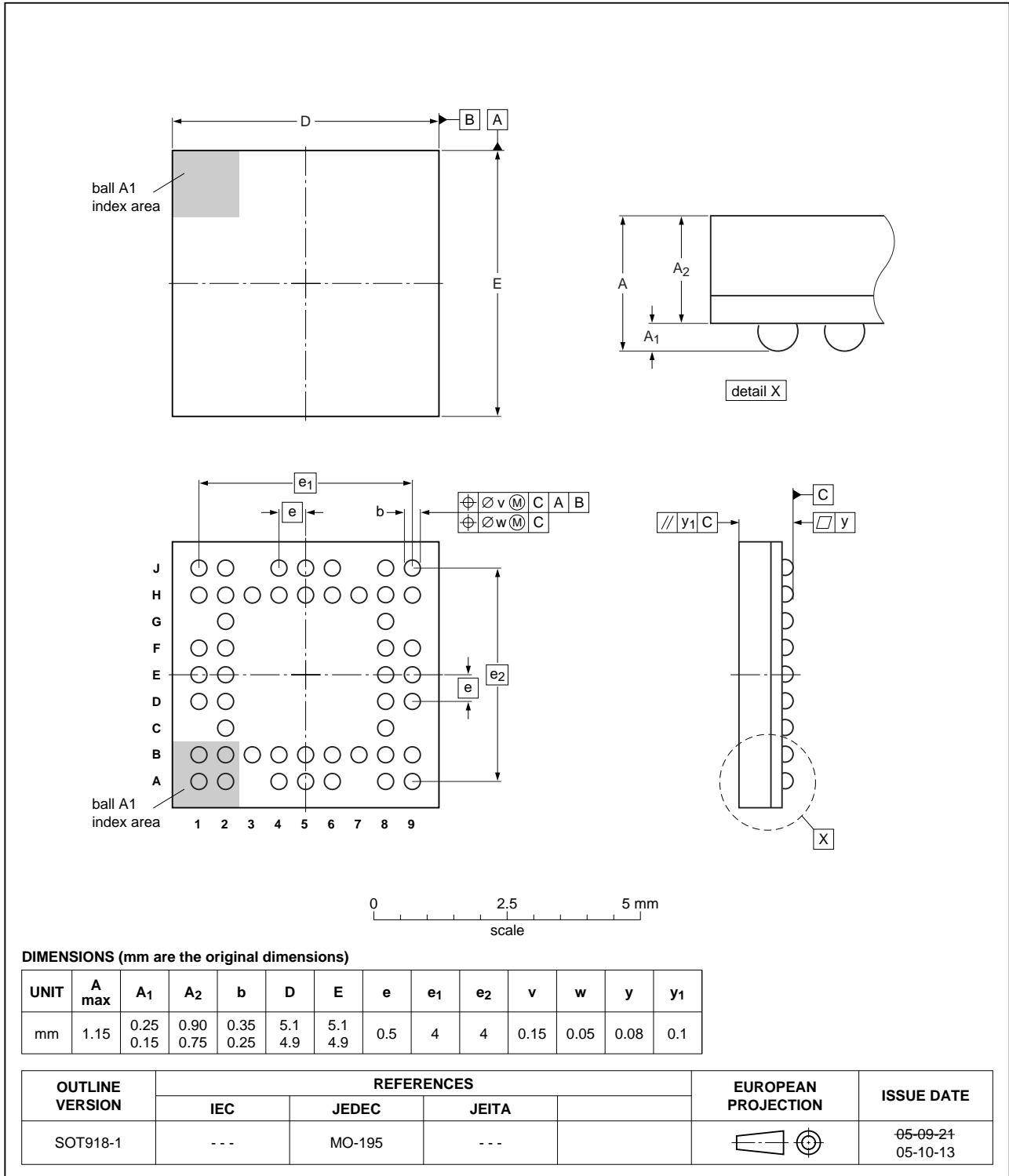

Fig 5. Package outline TFBGA48 (SOT918-1)

## 14. Soldering of SMD packages

This text provides a very brief insight into a complex technology. A more in-depth account of soldering ICs can be found in Application Note *AN10365 "Surface mount reflow soldering description"*.

### 14.1 Introduction to soldering

Soldering is one of the most common methods through which packages are attached to Printed Circuit Boards (PCBs), to form electrical circuits. The soldered joint provides both the mechanical and the electrical connection. There is no single soldering method that is ideal for all IC packages. Wave soldering is often preferred when through-hole and Surface Mount Devices (SMDs) are mixed on one printed wiring board; however, it is not suitable for fine pitch SMDs. Reflow soldering is ideal for the small pitches and high densities that come with increased miniaturization.

### 14.2 Wave and reflow soldering

Wave soldering is a joining technology in which the joints are made by solder coming from a standing wave of liquid solder. The wave soldering process is suitable for the following:

- Through-hole components
- Leaded or leadless SMDs, which are glued to the surface of the printed circuit board

Not all SMDs can be wave soldered. Packages with solder balls, and some leadless packages which have solder lands underneath the body, cannot be wave soldered. Also, leaded SMDs with leads having a pitch smaller than ~0.6 mm cannot be wave soldered, due to an increased probability of bridging.

The reflow soldering process involves applying solder paste to a board, followed by component placement and exposure to a temperature profile. Leaded packages, packages with solder balls, and leadless packages are all reflow solderable.

Key characteristics in both wave and reflow soldering are:

- Board specifications, including the board finish, solder masks and vias
- Package footprints, including solder thieves and orientation
- The moisture sensitivity level of the packages
- Package placement
- Inspection and repair
- Lead-free soldering versus SnPb soldering

### 14.3 Wave soldering

Key characteristics in wave soldering are:

- Process issues, such as application of adhesive and flux, clinching of leads, board transport, the solder wave parameters, and the time during which components are exposed to the wave
- Solder bath specifications, including temperature and impurities

### 14.4 Reflow soldering

Key characteristics in reflow soldering are:

- Lead-free versus SnPb soldering; note that a lead-free reflow process usually leads to higher minimum peak temperatures (see [Figure 6](#)) than a SnPb process, thus reducing the process window
- Solder paste printing issues including smearing, release, and adjusting the process window for a mix of large and small components on one board
- Reflow temperature profile; this profile includes preheat, reflow (in which the board is heated to the peak temperature) and cooling down. It is imperative that the peak temperature is high enough for the solder to make reliable solder joints (a solder paste characteristic). In addition, the peak temperature must be low enough that the packages and/or boards are not damaged. The peak temperature of the package depends on package thickness and volume and is classified in accordance with [Table 14](#) and [15](#)

**Table 14. SnPb eutectic process (from J-STD-020C)**

Package thickness (mm)	Package reflow temperature (°C)	
	Volume (mm <sup>3</sup> )	
	< 350	≥ 350
< 2.5	235	220
≥ 2.5	220	220

**Table 15. Lead-free process (from J-STD-020C)**

Package thickness (mm)	Package reflow temperature (°C)		
	Volume (mm <sup>3</sup> )		
	< 350	350 to 2000	> 2000
< 1.6	260	260	260
1.6 to 2.5	260	250	245
> 2.5	250	245	245

Moisture sensitivity precautions, as indicated on the packing, must be respected at all times.

Studies have shown that small packages reach higher temperatures during reflow soldering, see [Figure 6](#).

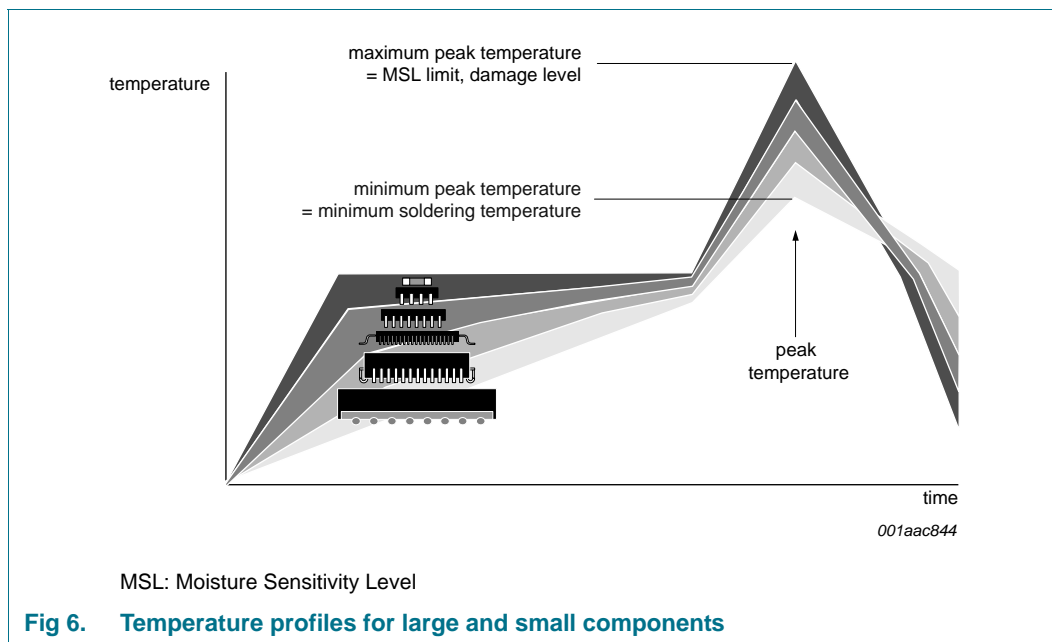

For further information on temperature profiles, refer to Application Note AN10365 “Surface mount reflow soldering description”.

## 15. Abbreviations

**Table 16. Abbreviations**

Acronym	Description
AUX	Auxiliary channel (in DisplayPort definition)
CDM	Charged-Device Model
CMOS	Complementary Metal-Oxide Semiconductor
CPU	Central Processing Unit
DP	DisplayPort
DVI	Digital Video Interface
ESD	ElectroStatic Discharge
GPU	Graphics Processor Unit
HBM	Human Body Model
HDMI	High-Definition Multimedia Interface
I/O	Input/Output
PCI	Peripheral Component Interconnect

## 16. Revision history

Table 17. Revision history

Document ID	Release date	Data sheet status	Change notice	Supersedes
CBTL06DP212 v.2	20111103	Product data sheet	-	CBTL06DP212 v.1
Modifications:	• <a href="#">Table 2 "Package marking"</a> : Line A marking corrected from "6DP212" to "6D212"			
CBTL06DP212 v.1	20110221	Product data sheet	-	-

## 17. Legal information

### 17.1 Data sheet status

Document status <sup>[1][2]</sup>	Product status <sup>[3]</sup>	Definition
Objective [short] data sheet	Development	This document contains data from the objective specification for product development.
Preliminary [short] data sheet	Qualification	This document contains data from the preliminary specification.
Product [short] data sheet	Production	This document contains the product specification.

[1] Please consult the most recently issued document before initiating or completing a design.

[2] The term 'short data sheet' is explained in section "Definitions".

[3] The product status of device(s) described in this document may have changed since this document was published and may differ in case of multiple devices. The latest product status information is available on the Internet at URL <http://www.nxp.com>.

### 17.2 Definitions

**Draft** — The document is a draft version only. The content is still under internal review and subject to formal approval, which may result in modifications or additions. NXP Semiconductors does not give any representations or warranties as to the accuracy or completeness of information included herein and shall have no liability for the consequences of use of such information.

**Short data sheet** — A short data sheet is an extract from a full data sheet with the same product type number(s) and title. A short data sheet is intended for quick reference only and should not be relied upon to contain detailed and full information. For detailed and full information see the relevant full data sheet, which is available on request via the local NXP Semiconductors sales office. In case of any inconsistency or conflict with the short data sheet, the full data sheet shall prevail.

**Product specification** — The information and data provided in a Product data sheet shall define the specification of the product as agreed between NXP Semiconductors and its customer, unless NXP Semiconductors and customer have explicitly agreed otherwise in writing. In no event however, shall an agreement be valid in which the NXP Semiconductors product is deemed to offer functions and qualities beyond those described in the Product data sheet.

### 17.3 Disclaimers

**Limited warranty and liability** — Information in this document is believed to be accurate and reliable. However, NXP Semiconductors does not give any representations or warranties, expressed or implied, as to the accuracy or completeness of such information and shall have no liability for the consequences of use of such information.

In no event shall NXP Semiconductors be liable for any indirect, incidental, punitive, special or consequential damages (including - without limitation - lost profits, lost savings, business interruption, costs related to the removal or replacement of any products or rework charges) whether or not such damages are based on tort (including negligence), warranty, breach of contract or any other legal theory.

Notwithstanding any damages that customer might incur for any reason whatsoever, NXP Semiconductors' aggregate and cumulative liability towards customer for the products described herein shall be limited in accordance with the *Terms and conditions of commercial sale* of NXP Semiconductors.

**Right to make changes** — NXP Semiconductors reserves the right to make changes to information published in this document, including without limitation specifications and product descriptions, at any time and without notice. This document supersedes and replaces all information supplied prior to the publication hereof.

**Suitability for use** — NXP Semiconductors products are not designed, authorized or warranted to be suitable for use in life support, life-critical or safety-critical systems or equipment, nor in applications where failure or

malfunction of an NXP Semiconductors product can reasonably be expected to result in personal injury, death or severe property or environmental damage. NXP Semiconductors accepts no liability for inclusion and/or use of NXP Semiconductors products in such equipment or applications and therefore such inclusion and/or use is at the customer's own risk.

**Applications** — Applications that are described herein for any of these products are for illustrative purposes only. NXP Semiconductors makes no representation or warranty that such applications will be suitable for the specified use without further testing or modification.

Customers are responsible for the design and operation of their applications and products using NXP Semiconductors products, and NXP Semiconductors accepts no liability for any assistance with applications or customer product design. It is customer's sole responsibility to determine whether the NXP Semiconductors product is suitable and fit for the customer's applications and products planned, as well as for the planned application and use of customer's third party customer(s). Customers should provide appropriate design and operating safeguards to minimize the risks associated with their applications and products.

NXP Semiconductors does not accept any liability related to any default, damage, costs or problem which is based on any weakness or default in the customer's applications or products, or the application or use by customer's third party customer(s). Customer is responsible for doing all necessary testing for the customer's applications and products using NXP Semiconductors products in order to avoid a default of the applications and the products or of the application or use by customer's third party customer(s). NXP does not accept any liability in this respect.

**Limiting values** — Stress above one or more limiting values (as defined in the Absolute Maximum Ratings System of IEC 60134) will cause permanent damage to the device. Limiting values are stress ratings only and (proper) operation of the device at these or any other conditions above those given in the Recommended operating conditions section (if present) or the Characteristics sections of this document is not warranted. Constant or repeated exposure to limiting values will permanently and irreversibly affect the quality and reliability of the device.

**Terms and conditions of commercial sale** — NXP Semiconductors products are sold subject to the general terms and conditions of commercial sale, as published at <http://www.nxp.com/profile/terms>, unless otherwise agreed in a valid written individual agreement. In case an individual agreement is concluded only the terms and conditions of the respective agreement shall apply. NXP Semiconductors hereby expressly objects to applying the customer's general terms and conditions with regard to the purchase of NXP Semiconductors products by customer.

**No offer to sell or license** — Nothing in this document may be interpreted or construed as an offer to sell products that is open for acceptance or the grant, conveyance or implication of any license under any copyrights, patents or other industrial or intellectual property rights.

**Export control** — This document as well as the item(s) described herein may be subject to export control regulations. Export might require a prior authorization from competent authorities.

**Non-automotive qualified products** — Unless this data sheet expressly states that this specific NXP Semiconductors product is automotive qualified, the product is not suitable for automotive use. It is neither qualified nor tested in accordance with automotive testing or application requirements. NXP Semiconductors accepts no liability for inclusion and/or use of non-automotive qualified products in automotive equipment or applications.

In the event that customer uses the product for design-in and use in automotive applications to automotive specifications and standards, customer (a) shall use the product without NXP Semiconductors' warranty of the product for such automotive applications, use and specifications, and (b) whenever customer uses the product for automotive applications beyond NXP Semiconductors' specifications such use shall be solely at customer's own risk, and (c) customer fully indemnifies NXP Semiconductors for any liability, damages or failed product claims resulting from customer design and use of the product for automotive applications beyond NXP Semiconductors' standard warranty and NXP Semiconductors' product specifications.

## 18. Contact information

For more information, please visit: <http://www.nxp.com>

For sales office addresses, please send an email to: [salesaddresses@nxp.com](mailto:salesaddresses@nxp.com)

## 17.4 Licenses

### Purchase of NXP ICs with HDMI technology

Use of an NXP IC with HDMI technology in equipment that complies with the HDMI standard requires a license from HDMI Licensing LLC, 1060 E. Arques Avenue Suite 100, Sunnyvale CA 94085, USA, e-mail: [admin@hdmi.org](mailto:admin@hdmi.org).

## 17.5 Trademarks

Notice: All referenced brands, product names, service names and trademarks are the property of their respective owners.

**19. Contents**

**1 General description . . . . . 1**

**2 Features and benefits . . . . . 1**

**3 Applications . . . . . 2**

**4 Ordering information . . . . . 2**

**5 Marking . . . . . 2**

**6 Functional diagram . . . . . 3**

**7 Pinning information . . . . . 4**

7.1 Pinning . . . . . 4

7.2 Pin description . . . . . 5

**8 Functional description . . . . . 6**

8.1 Multiplexer/switch select functions . . . . . 6

**9 Limiting values . . . . . 7**

**10 Recommended operating conditions . . . . . 7**

**11 Characteristics . . . . . 8**

11.1 General characteristics . . . . . 8

11.2 DisplayPort channel characteristics . . . . . 8

11.3 AUX and DDC ports . . . . . 9

11.4 HPDIN input, HPD\_x outputs . . . . . 9

11.5 GPU\_SEL and DDC\_AUX\_SEL inputs . . . . . 9

**12 Application information . . . . . 10**

12.1 Special considerations . . . . . 10

**13 Package outline . . . . . 11**

**14 Soldering of SMD packages . . . . . 12**

14.1 Introduction to soldering . . . . . 12

14.2 Wave and reflow soldering . . . . . 12

14.3 Wave soldering . . . . . 12

14.4 Reflow soldering . . . . . 13

**15 Abbreviations . . . . . 14**

**16 Revision history . . . . . 15**

**17 Legal information . . . . . 16**

17.1 Data sheet status . . . . . 16

17.2 Definitions . . . . . 16

17.3 Disclaimers . . . . . 16

17.4 Licenses . . . . . 17

17.5 Trademarks . . . . . 17

**18 Contact information . . . . . 17**

**19 Contents . . . . . 18**

Please be aware that important notices concerning this document and the product(s) described herein, have been included in section 'Legal information'.



© NXP B.V. 2011. All rights reserved.

For more information, please visit: <http://www.nxp.com>  
 For sales office addresses, please send an email to: [salesaddresses@nxp.com](mailto:salesaddresses@nxp.com)

Date of release: 3 November 2011  
 Document identifier: CBTL06DP212

## Looking for pricing, stock, or lifecycle information?

Click below to explore more details on WIN SOURCE:

-  [View CBTL06DP212EE,118 on WIN SOURCE](#)
-  [NXP / Nexperia Information](#)

## Optimize Your Supply Chain with WIN SOURCE Solutions

-  Global Sourcing Solution
-  Obsolete Management
-  Cost Control Management
-  Shortage Management
-  Alternative Solution
-  Excess Inventory Management