



**THE DATASHEET OF
EFO-H418MS12**



SAW Resonators

EFOH□□□□MS03□

EFOH□□□□MS12□

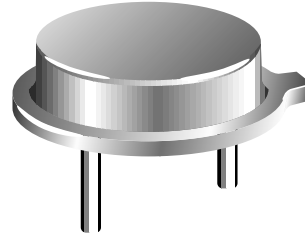

SAW Resonators are capable of fundamental wave oscillation, and are particularly suited for simplification, size reduction, and stabilization of circuit, compared with conventional LC oscillation and quartz crystal oscillation.

■ Features

- Capable of fundamental oscillation
- Superior temperature characteristics
- Suited for simplification, size reduction, and stabilization of the circuit
- Wide frequency range: 200 to 700 MHz (available for requested frequency)

■ Recommended Applications

- Capable of fundamental oscillation
- Superior temperature characteristics
- Suited for simplification, size reduction, and stabilization of the circuit
- Wide frequency range: 200 to 700 MHz (available for requested frequency)

■ Explanation of Part Numbers

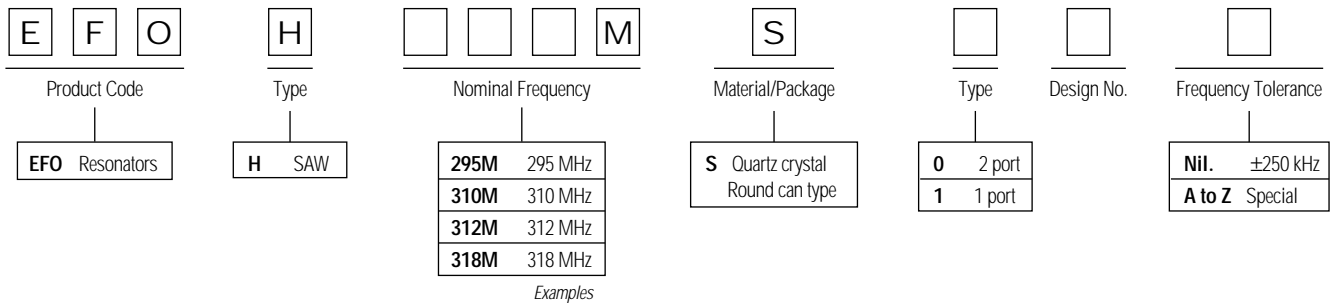

■ Ratings and Characteristics

2 Port Type—Operating temperature range: -20 to 80°C / Phase shift: 180°

Part No.	Center Frequency	Insertion Loss (dB)	Loaded Q	Capacitance (pF)	Temperature Characteristics
EFOH200MS03	200.000 ±0.250	15 max.	700 min.	1.3 ±0.3	Max. frequency drift: -150 to 50 ppm/ °C (-20 to 80°C)
EFOH214MS03	214.000 ±0.250				
EFOH220MS03	220.000 ±0.250				
EFOH2243S03	224.300 ±0.250				
EFOH225MS03	224.700 ±0.250				
EFOH235MS03	235.400 ±0.250				
EFOH245MS03	245.000 ±0.250				
EFOH250MS03	250.000 ±0.250				
EFOH270MS03	270.000 ±0.250				
EFOH287MS03	287.995 ±0.250				
EFOH290MS03	290.000 ±0.250				
EFOH295MS03	295.000 ±0.250				
EFOH300MS03	300.000 ±0.250				

(continued on following page)

■ Ratings and Characteristics (cont'd)

2 Port Type (cont'd)—Operating temperature range: -20 to 80°C / Phase shift: 180°

Part No.	Center Frequency	Insertion Loss (dB)	Loaded Q	Capacitance (pF)	Temperature Characteristics
EFOH301MS03	300.700 ±0.250	15 max.	700 min.	1.3 ± 0.3	Max. frequency drift: -150 to 50 ppm/°C (-20 to 80°C)
EFOH304MS03	303.875 ±0.250				
EFOH3043S03	304.300 ±0.250				
EFOH3046S03	304.600 ±0.250				
EFOH306MS03	306.000 ±0.250				
EFOH307MS03	307.300 ±0.250				
EFOH310MS03	310.000 ±0.250				
EFOH311MS03	310.700 ±0.250				
EFOH312MS03	312.000 ±0.250				
EFOH314MS03	314.200 ±0.250				
EFOH3145S03	314.575 ±0.250				
EFOH3148S03	314.870 ±0.250				
EFOH315MS03	315.000 ±0.250				
EFOH318MS03	318.000 ±0.250				
EFOH3195S03	319.500 ±0.250				
EFOH330MS03	330.000 ±0.250				
EFOH350MS03	350.000 ±0.250				
EFOH370MS03	370.000 ±0.250				
EFOH379MS03	379.000 ±0.250				
EFOH384MS03	384.000 ±0.250				
EFOH390MS03	390.000 ±0.250				
EFOH395MS03	395.000 ±0.250				
EFOH400MS03	400.000 ±0.250				
EFOH402MS03	402.080 ±0.250				
EFOH403MS03	403.550 ±0.250				
EFOH407MS03	407.350 ±0.250				
EFOH410MS03	410.000 ±0.250				
EFOH411MS03	410.700 ±0.250				
EFOH417MS03	417.000 ±0.250				
EFOH418MS03	418.000 ±0.250				
EFOH419MS03	419.000 ±0.250				
EFOH423MS03	423.220 ±0.250				
EFOH425MS03	425.000 ±0.250				
EFOH430MS03	430.000 ±0.250				
EFOH4332S03	433.200 ±0.250				
EFOH4337S03	433.750 ±0.250				
EFOH338S03	433.890 ±0.250				
EFOH434MS03	433.920 ±0.250				
EFOH450MS03	450.000 ±0.250				
EFOH453MS03	450.000 ±0.250				
EFOH458MS03	458.850 ±0.250				
EFOH470MS03	470.000 ±0.250				
EFOH490MS03	490.000 ±0.250				
EFOH510MS03	510.000 ±0.250				
EFOH530MS03	530.000 ±0.250				
EFOH550MS03	550.000 ±0.250				
EFOH570MS03	570.000 ±0.250				
EFOH590MS03	590.000 ±0.250				
EFOH610MS03	610.000 ±0.250				
EFOH630MS03	630.000 ±0.250				
EFOH650MS03	650.000 ±0.250				
EFOH674MS03	674.000 ±0.250				
			500 min.		

■ Ratings and Characteristics (cont'd)

1 Port Type (cont'd)—Operating temperature range: -20 to 80°C

Part No.	Resonant Frequency	Resonant Resistance	Capacitance (pF)	Temperature Characteristics
EFOH100MS11	100.000 ±0.250	90 Ω max.	2.5 ±0.5	Max. frequency drift: -150 to 50 ppm/°C (-20 to 80°C)
EFOH160MS11	160.000 ±0.250	50 Ω max.	2.5 ±0.5	
EFOH168MS11	168.000 ±0.250	50 Ω max.	2.5 ±0.5	
EFOH176MS11	176.000 ±0.250	50 Ω max.	2.5 ±0.5	
EFOH192MS11	192.250 ±0.250	50 Ω max.	2.5 ±0.5	
EFOH200MS12	200.000 ±0.250	30 Ω max.	3.0 ±0.5	
EFOH224MS12	224.500 ±0.250	30 Ω max.	3.0 ±0.5	
EFOH225MS12	224.700 ±0.250	30 Ω max.	2.5 ±0.5	
EFOH235MS12	235.200 ±0.250	30 Ω max.	2.5 ±0.5	
EFOH240MS12	240.000 ±0.250	30 Ω max.	3.0 ±0.5	
EFOH246MS12	246.150 ±0.250	30 Ω max.	2.5 ±0.5	
EFOH264MS11	264.000 ±0.250	40 Ω max.	1.4 ±0.5	
EFOH266MS11	266.000 ±0.250	40 Ω max.	1.4 ±0.5	
EFOH280MS16	280.000 ±0.250	30 Ω max.	2.0 ±0.5	
EFOH290MS12	290.000 ±0.250	30 Ω max.	2.0 ±0.5	
EFOH293MS12	293.650 ±0.250	30 Ω max.	2.0 ±0.5	
EFOH300MS11	300.000 ±0.250	40 Ω max.	1.4 ±0.5	
EFOH300MS12	300.00 ±0.250	30 Ω max.	2.0 ±0.5	
EFOH301MS12	300.700 ±0.250	30 Ω max.	2.0 ±0.5	
EFOH303MS11	303.000 ±0.250	40 Ω max.	1.4 ±0.5	
EFOH304MS11	303.875 ±0.250	40 Ω max.	1.4 ±0.5	
EFOH304MS12	303.875 ±0.250	40 Ω max.	1.4 ±0.5	
EFOH3043S16	304.300 ±0.250	30 Ω max.	2.0 ±0.5	
EFOH308MS12	308.000 ±0.250	30 Ω max.	2.0 ±0.5	
EFOH310MS12	310.000 ±0.250	30 Ω max.	2.0 ±0.5	
EFOH312MS12	312.000 ±0.250	30 Ω max.	2.0 ±0.5	
EFOH313MS12	313.500 ±0.250	30 Ω max.	2.0 ±0.5	
EFOH314MS12	314.200 ±0.250	30 Ω max.	2.0 ±0.5	
EFOH315MS16	315.000 ±0.250	30 Ω max.	2.0 ±0.5	
EFOH316MS16	316.025 ±0.250	30 Ω max.	2.0 ±0.5	
EFOH318MS12	318.000 ±0.250	30 Ω max.	2.0 ±0.5	
EFOH320MS11	320.000 ±0.250	40 Ω max.	1.4 ±0.5	
EFOH325MS12	325.700 ±0.250	30 Ω max.	2.0 ±0.5	
EFOH328MS11	328.000 ±0.250	40 Ω max.	1.4 ±0.5	
EFOH330MS12	330.000 ±0.250	30 Ω max.	2.0 ±0.5	
EFOH333MS11	333.000 ±0.250	40 Ω max.	1.4 ±0.5	
EFOH334MS12	334.000 ±0.250	30 Ω max.	2.0 ±0.5	
EFOH345MS16	345.000 ±0.250	30 Ω max.	2.0 ±0.5	
EFOH355MS12	355.700 ±0.250	30 Ω max.	2.0 ±0.5	
EFOH360MS12	360.000 ±0.250	30 Ω max.	2.0 ±0.5	
EFOH364MS12	364.000 ±0.250	30 Ω max.	2.0 ±0.5	

Note: Also available are types other than above standard products in the frequency range of 200 to 700 MHz. Other frequencies are also available. Please consult Panasonic.

(continued on following page)

■ Ratings and Characteristics (cont'd)

1 Port Type (cont'd)—Operating temperature range: -20 to 80°C

Part No.	Resonant Frequency	Resonant Resistance	Capacitance (pF)	Temperature Characteristics
EFOH380MS11	380.000 ±0.250	40 Ω max.	1.4 ±0.5	Max. frequency drift: -150 to 50 ppm/°C (-20 to 80°C)
EFOH389MS12	389.000 ±0.250	30 Ω max.	2.0 ±0.5	
EFOH396MS11	396.000 ±0.250	40 Ω max.	1.4 ±0.5	
EFOH400MS11	400.000 ±0.250	40 Ω max.	1.4 ±0.5	
EFOH404MS12	404.000 ±0.250	30 Ω max.	2.0 ±0.5	
EFOH407MS12	407.300 ±0.250	30 Ω max.	2.0 ±0.5	
EFOH417MS12	417.000 ±0.250	30 Ω max.	2.0 ±0.5	
EFOH418MS16	418.000 ±0.250	30 Ω max.	2.0 ±0.5	
EFOH419MS12	419.000 ±0.250	30 Ω max.	2.0 ±0.5	
EFOH422MS12	422.500 ±0.250	30 Ω max.	2.0 ±0.5	
EFOH423MS16	423.220 ±0.250	30 Ω max.	2.0 ±0.5	
EFOH4332S12	433.200 ±0.250	30 Ω max.	2.0 ±0.5	
EFOH434MS16	433.920 ±0.250	30 Ω max.	2.0 ±0.5	
EFOH458MS11	458.650 ±0.250	40 Ω max.	1.4 ±0.5	
EFOH460MS12	460.000 ±0.250	30 Ω max.	2.0 ±0.5	
EFOH479MS16	460.000 ±0.250	30 Ω max.	2.0 ±0.5	
EFOH490MS16	460.000 ±0.250	30 Ω max.	2.0 ±0.5	

Note: Also available are types other than above standard products in the frequency range of 200 to 700 MHz. Other frequencies are also available. Please consult Panasonic.

■ Dimensions in mm (not to scale)

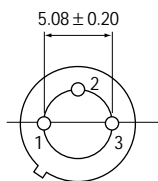
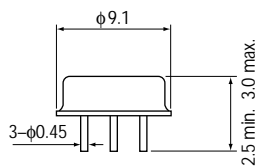

Terminal
 (1) Input or Output
 (2) Output or Input
 (3) Ground

■ Test Circuits Diagram

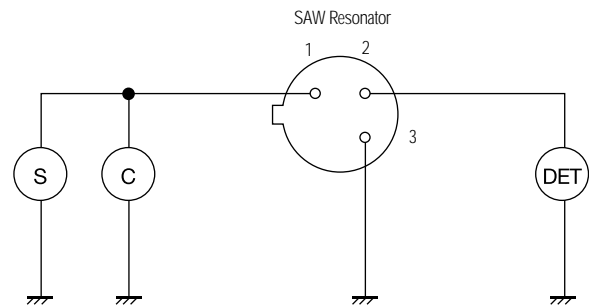

Standard measuring voltage: -6 dBm between pins 1 and 2 (0.112 Vrms)

S: Standard signal generator (Output impedance 50 Ω)

C: Frequency counter

DET: Detector (Input impedance 50 Ω)

■ Application Example (cont'd)

Local Oscillation Circuit

(Local Oscillation Circuit for Receiver)

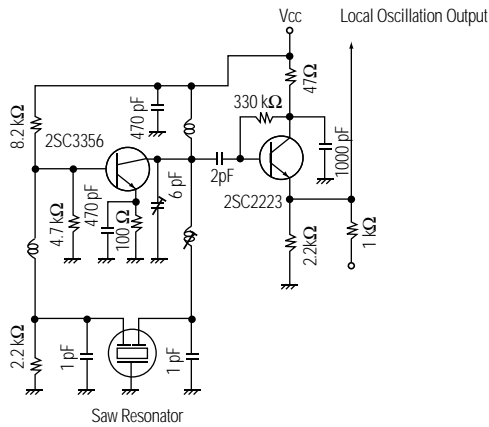

■ Application Notes

- 1. Electrostatic Discharge.** The SAW filters and SAW resonators, which have extremely narrow spacings between their interdigitated electrodes, shall be free from high voltage spikes such as "Electrostatic Discharges," to prevent failures and damages of the devices. The following countermeasures are recommended: (a) ground human body via earth band; (b) set electricity rejecting sheet to working table.
- 2. Grounding of the Equipment.** Direct impression/application of line voltage to the SAW filters and resonators shall cause short circuits between their interdigitated electrodes.
- 3. Operating Temperature Range.** The SAW filters and resonators shall not be operated beyond the specified "Operating Temperature Range" in the catalog and the specifications.
- 4. R.F. Input Power.** The SAW filters and resonators shall not be operated beyond the specified "Maximum R.F. Input Power Ratings" listed in specifications.
- 5. Application of DC Voltage.** Application of DC voltage to the SAW filters and resonators shall cause failures and deterioration of the devices. DC voltage shall be cut by a capacitor.
- 6. Abnormal Mechanical Stresses.** Abnormal/excess mechanical stress such as pulling or bending forces shall not be applied to the SAW filters and resonators for preventing failures and damages of the devices.
- 7. Ultrasonic Cleaning.** Ultrasonic cleaning may cause deterioration and damage in mechanical and electrical characteristics of the devices, and shall not be applied to the SAW filters and resonators.
- 8. Soldering to the Metallic Cases.** The metallic cases of the SAW filters and resonators shall not be soldered for the purpose of grounding. Soldering to the metallic cases may cause deterioration or damage in mechanical and electrical characteristics.
- 9. Operating and Storage Conditions.** The SAW filters and resonators shall not be operated and stored under the following environmental conditions: (a) exposed directly to water or salt water; (b) exposed directly to sunlight; (c) under conditions of humidity and dust; (d) under conditions of corrosive atmosphere such as hydrogen sulfide, sulfurous acid, chlorine, or ammonia.

Typical Characteristics

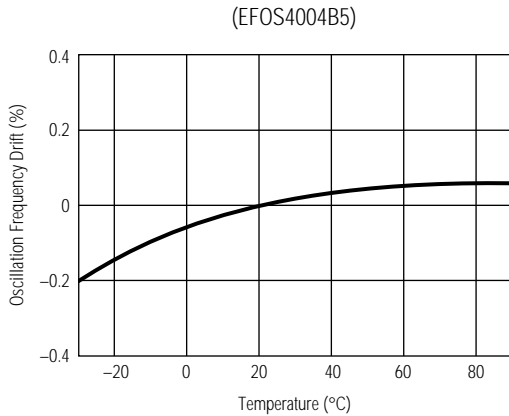

Recommended Land Dimensions

Type P

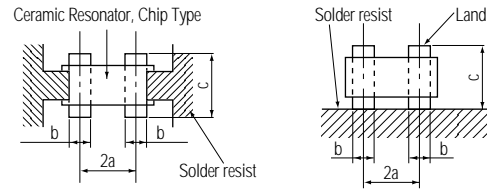

Type S

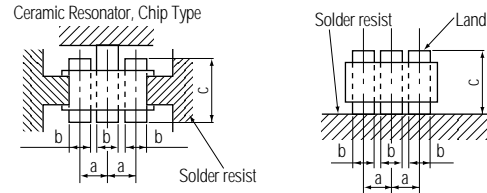

Packaging Specifications

Standard Packing Quantity

Style	Embossed Taping	Bulk
Quantity	2,500 pcs./reel	500 pcs./bag

Application Notes

Soldering Conditions

Reflow soldering shall be done at 220°C for less than 10 seconds, and peak temperature of 240°C. Flow soldering method and dip soldering method shall not be applied.

Dimensions for Reel in mm (not to scale)

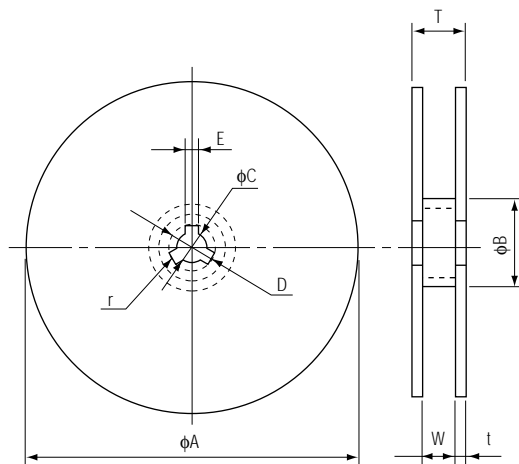

Dimensions (mm)

ϕA	330
ϕB	50 min.
C	13.0 \pm 0.5
D	21.0 \pm 0.8
E	2.0 \pm 0.2
W	16.4 $^{+2.0}_0$
T	22.4 max.
t	3 max.
r	1.0

Looking for pricing, stock, or lifecycle information?

Click below to explore more details on WIN SOURCE:

 [View EFO-H418MS12 on WIN SOURCE](#)

 [Panasonic Information](#)

Optimize Your Supply Chain with WIN SOURCE Solutions

-  Global Sourcing Solution
-  Obsolete Management
-  Cost Control Management
-  Shortage Management
-  Alternative Solution
-  Excess Inventory Management