



**THE DATASHEET OF
CAT3637HV3-GT2**



CAT3637

6-Channel Programmable High Efficiency LED Driver

Description

The CAT3637 is a high efficiency fractional charge pump that can drive up to six LEDs programmable by a 1-wire digital interface. The inclusion of a 1.33x fractional charge pump mode increases device efficiency by up to 10% over traditional 1.5x charge pumps with no added external capacitors.

Low noise input ripple is achieved by operating at a constant switching frequency which allows the use of small external ceramic capacitors. The multi-fractional charge pump supports a wide range of input voltages from 2.5 V to 5.5 V.

The EN/SET logic input functions as a chip enable and a digital programming interface for setting the current in the LED channels. The 1-wire pulse-programming interface supports 15 linear steps from zero current to 30 mA full-brightness in 2 mA steps.

The device is available in a tiny 16-pad TQFN 3 x 3 mm package with a maximum height of 0.8 mm.

ON Semiconductor's 1.33x, charge pump switching architecture is patented.

Features

- High Efficiency 1.33x Charge Pump
- Charge Pump: 1x, 1.33x, 1.5x, 2x
- Drives 6 LEDs Between 30 mA and 0 mA Each
- 1-wire EZDim™ Interface with 2 mA Step
- Power Efficiency up to 92%
- Low Noise Input Ripple in All Modes
- “Zero” Current Shutdown Mode
- Soft Start and Current Limiting
- Short Circuit Protection
- Thermal Shutdown Protection
- Tiny 3 mm x 3 mm, 16-pad TQFN Package
- These Devices are Pb-Free, Halogen Free/BFR Free and are RoHS Compliant

Applications

- LCD Display Backlight
- Cellular Phones
- Digital Still Cameras
- Handheld Devices



ON Semiconductor®

<http://onsemi.com>



TQFN-16
HV3 SUFFIX
CASE 510AD

PIN CONNECTIONS

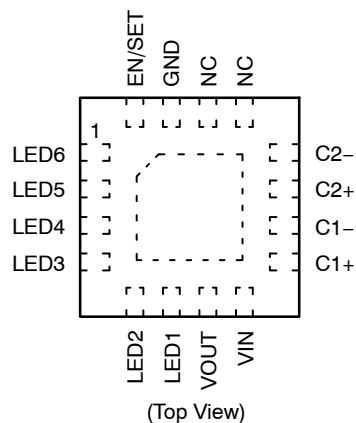

MARKING DIAGRAM

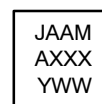

JAAM = CAT3637HV3-GT2
A = Assembly Location
XXX = Last Three Digits of Assembly Lot Number
Y = Production Year (Last Digit)
WW = Production Week (Two Digits)

ORDERING INFORMATION

| Device | Package | Shipping† |
|----------------------------|----------------------|-----------------------|
| CAT3637HV3-GT2 (Note 1) | TQFN-16 (Pb-Free) | 2000 / Tape & Reel |

†For information on tape and reel specifications, including part orientation and tape sizes, please refer to our Tape and Reel Packaging Specifications Brochure, BRD8011/D.

1. NiPdAu Plated Finish (RoHS-compliant).

CAT3637

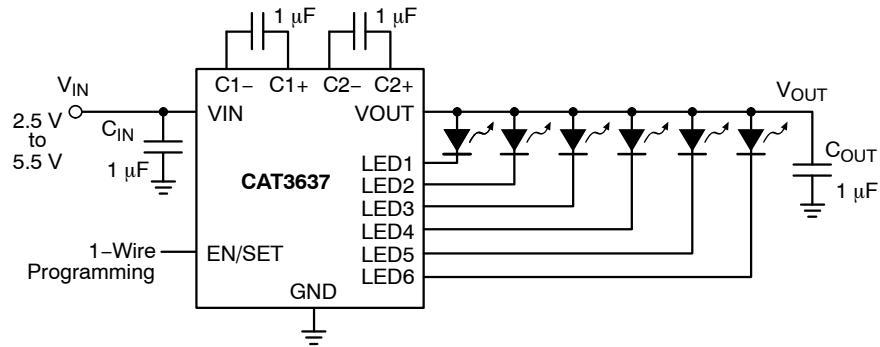

Figure 1. Typical Application Circuit

Table 1. ABSOLUTE MAXIMUM RATINGS

| Parameter | Rating | Unit |
|-------------------------------------|-------------|------|
| VIN, LEDx, C1±, C2± voltage | 6 | V |
| VOUT Voltage | 7 | V |
| EN/SET Voltage | VIN + 0.7 V | V |
| Storage Temperature Range | -65 to +160 | °C |
| Junction Temperature Range (Note 2) | -40 to +150 | °C |
| Lead Temperature | 300 | °C |

Stresses exceeding those listed in the Maximum Ratings table may damage the device. If any of these limits are exceeded, device functionality should not be assumed, damage may occur and reliability may be affected.

Table 2. RECOMMENDED OPERATING CONDITIONS

| Parameter | Range | Unit |
|------------------------------------|------------|------|
| VIN | 2.5 to 5.5 | V |
| Ambient Temperature Range (Note 2) | -40 to +85 | °C |
| ILED per LED pin | 0 to 30 | mA |
| Total Output Current | 0 to 180 | mA |

Functional operation above the stresses listed in the Recommended Operating Ranges is not implied. Extended exposure to stresses beyond the Recommended Operating Ranges limits may affect device reliability.

2. Package thermal resistance is below 50°C/W when mounted on FR4 board.

CAT3637

Table 3. ELECTRICAL OPERATING CHARACTERISTICS

(over recommended operating conditions unless specified otherwise) $V_{IN} = 3.6\text{ V}$, $EN = \text{High}$, $T_{AMB} = 25^\circ\text{C}$

| Symbol | Name | Conditions | Min | Typ | Max | Units |
|--------------------------------------|--|---|------------|--------------------------|------------|----------------------|
| I_Q | Quiescent Current | 1x mode, $V_{IN} = 4.2\text{ V}$ 1.33x mode, $V_{IN} = 3.3\text{ V}$ 1.5x mode, $V_{IN} = 2.8\text{ V}$ 2x mode, $V_{IN} = 2.5\text{ V}$ | | 1.5 2.8 3.7 3.8 | | mA |
| I_{QSHDN} | Shutdown Current | $V_{EN} = 0\text{ V}$ | | | 1 | μA |
| $I_{LED-ACC}$ | LED Current Accuracy | $2\text{ mA} \leq I_{LED} \leq 30\text{ mA}$ | | ± 3 | | % |
| $I_{LED-DEV}$ | LED Channel Matching | $\frac{I_{LED} - I_{LEDAVG}}{I_{LEDAVG}}$ | | ± 1 | | % |
| R_{OUT} | Output Resistance (open loop) | 1x mode, $I_{OUT} = 120\text{ mA}$ 1.33x mode, $I_{OUT} = 120\text{ mA}$ 1.5x mode, $I_{OUT} = 120\text{ mA}$ 2x mode, $I_{OUT} = 120\text{ mA}$ | | 0.5 3.5 3.5 6 | | Ω |
| F_{OSC} | Charge Pump Frequency | 1.33x and 2x mode 1.5x mode | 0.6 0.8 | 0.8 1.1 | 1.1 1.4 | MHz |
| I_{SC_MAX} | Output short circuit Current Limit | $V_{OUT} < 0.5\text{ V}$ | | 80 | | mA |
| LED_{TH} | 1x to 1.33x or 1.33x to 1.5x or 1.5x to 2x Transition Thresholds at any LEDx pin | | | 150 | | mV |
| V_{HYS} | 1.33x to 1x Transition Hysteresis | $V_{IN} - \text{Highest LED } V_F$ | | 400 | | mV |
| T_{DF} | Mode Transition Filter Delay | | | 120 | | μs |
| I_{IN_MAX} | Input Current Limit | $V_{OUT} > 1\text{ V}$ | | 450 | | mA |
| $R_{EN/DIM}$ V_{HI} V_{LO} | EN/DIM Pin – Internal Pull-down Resistor – Logic High Level – Logic Low Level | | 1.3 | 100 | 0.4 | k Ω V V |
| T_{SD} | Thermal Shutdown | | | 150 | | $^\circ\text{C}$ |
| T_{HYS} | Thermal Hysteresis | | | 20 | | $^\circ\text{C}$ |
| V_{UVLO} | Undervoltage lockout (UVLO) threshold | | | 2 | | V |

Product parametric performance is indicated in the Electrical Characteristics for the listed test conditions, unless otherwise noted. Product performance may not be indicated by the Electrical Characteristics if operated under different conditions.

NOTE: Typical application circuit with external components is shown on page 2.

CAT3637

Table 4. RECOMMENDED EN/SET TIMING (For $2.5 \leq V_{IN} \leq 5.5$ V, over full ambient temperature range -40° to $+85^\circ\text{C}$.)

| Symbol | Name | Conditions | Min | Typ | Max | Units |
|-----------|-----------------------------|------------|-----|-----|-----|---------------|
| T_{LO} | EN/SET program low time | | 0.2 | | 100 | μs |
| T_{HI} | EN/SET program high time | | 0.2 | | | μs |
| T_{OFF} | EN/SET low time to shutdown | | 1.5 | | | ms |
| T_D | LED current settling time | | | 10 | | μs |

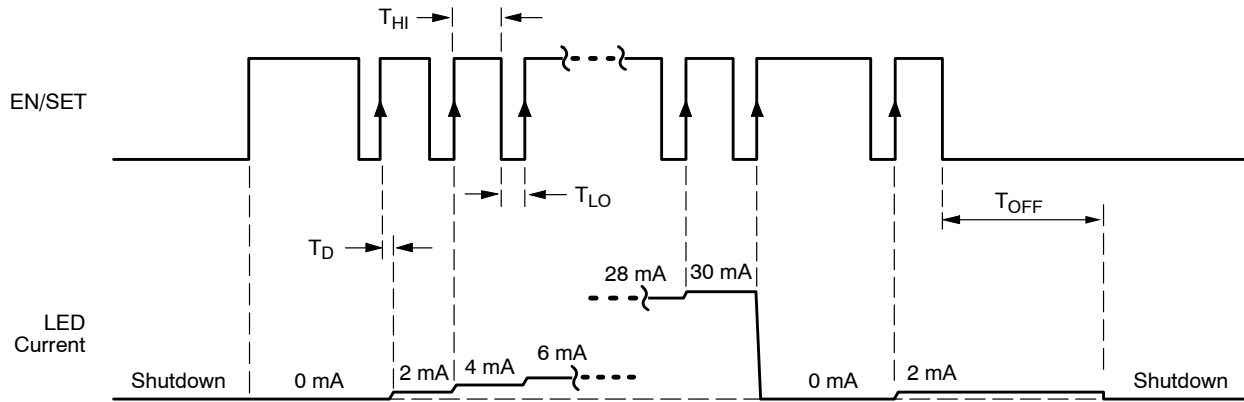

Figure 2. EN/SET One Wire Addressable Timing Diagram

TYPICAL PERFORMANCE CHARACTERISTICS

($V_{IN} = 3.6\text{ V}$, $I_{OUT} = 120\text{ mA}$ (6 LEDs at 20 mA), $C_{IN} = C_{OUT} = C_1 = C_2 = 1\ \mu\text{F}$, $T_{AMB} = 25^\circ\text{C}$ unless otherwise specified.)

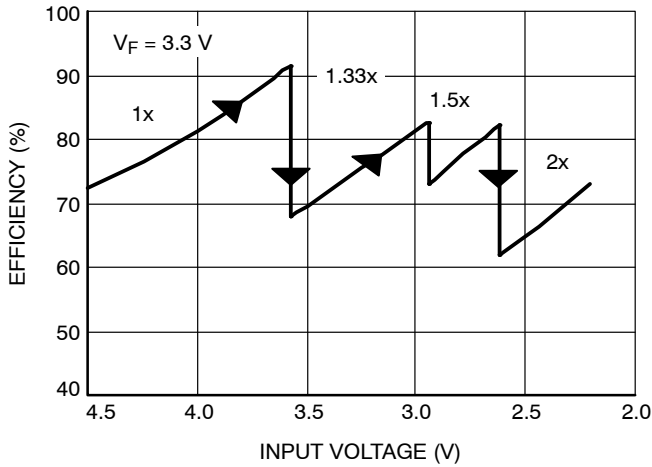

Figure 3. Efficiency vs. Input Voltage

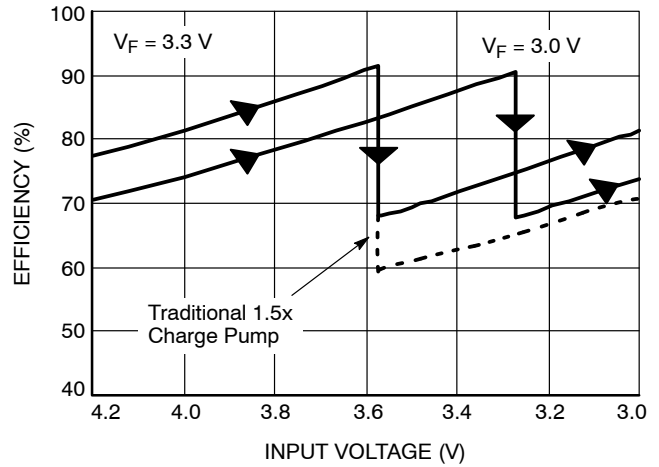

Figure 4. Efficiency vs. Li-Ion Voltage

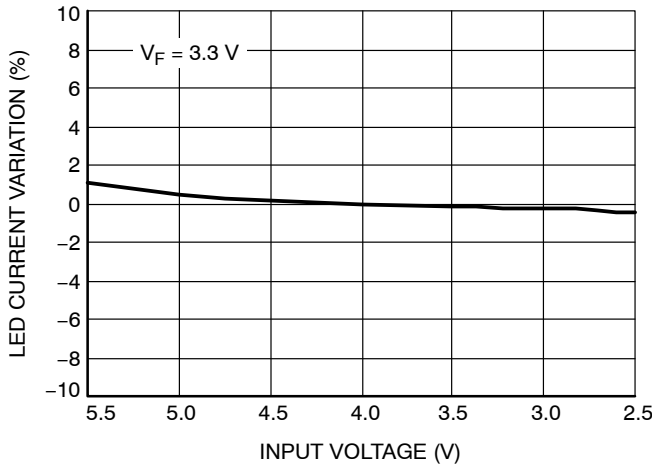

Figure 5. LED Current Change vs. Input Voltage

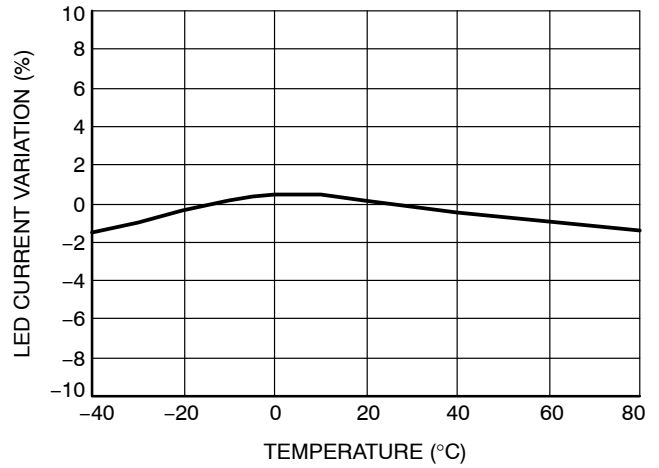

Figure 6. LED Current Change vs. Temperature

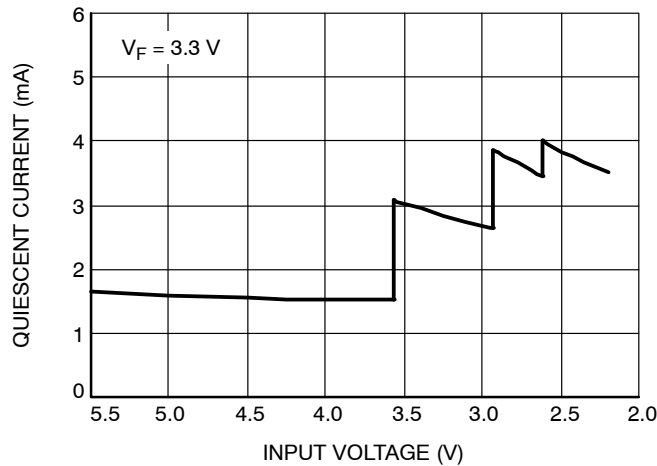

Figure 7. Quiescent Current vs. Input Voltage

TYPICAL PERFORMANCE CHARACTERISTICS

($V_{IN} = 3.6\text{ V}$, $I_{OUT} = 120\text{ mA}$ (6 LEDs at 20 mA), $C_{IN} = C_{OUT} = C_1 = C_2 = 1\ \mu\text{F}$, $T_{AMB} = 25^\circ\text{C}$ unless otherwise specified.)

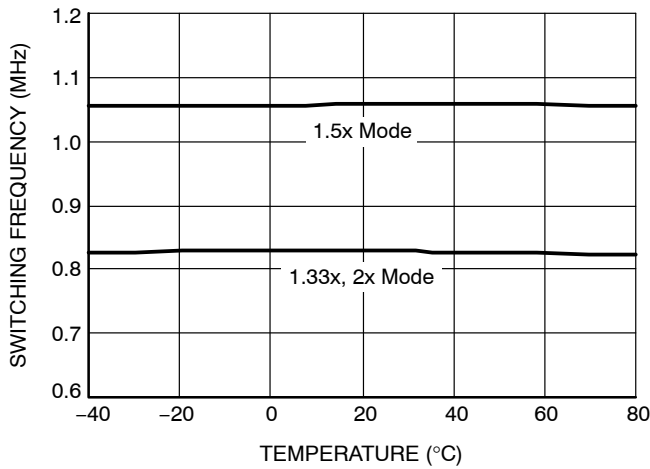

Figure 8. Switching Frequency vs. Temperature

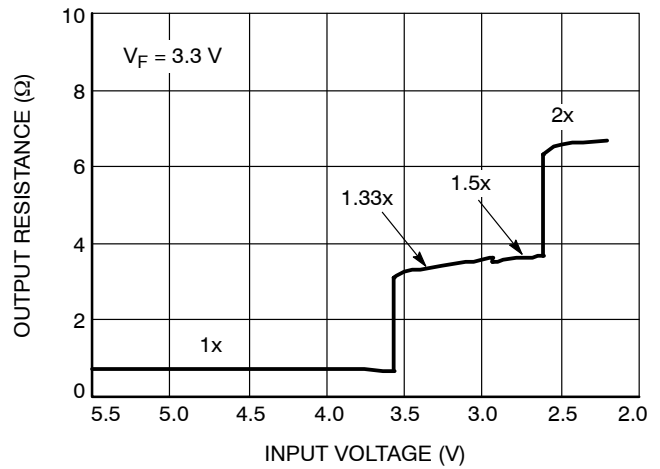

Figure 9. Output Resistance vs. Input Voltage

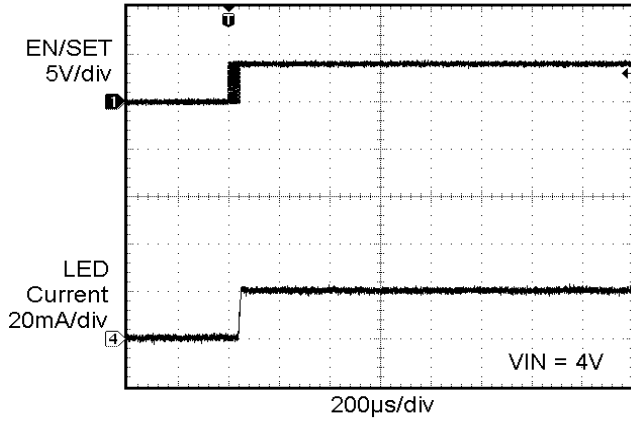

Figure 10. Power Up in 1x Mode

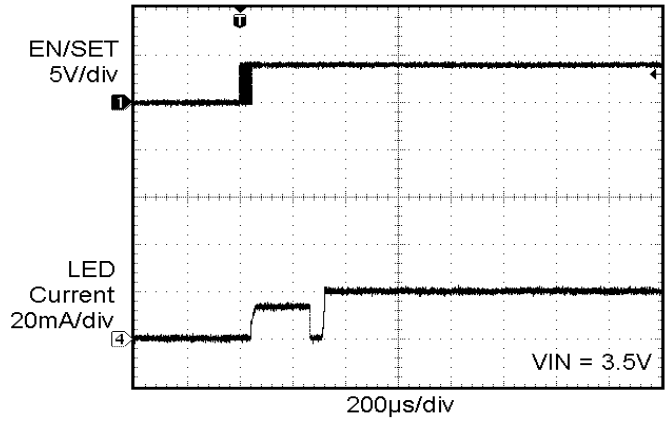

Figure 11. Power Up in 1.33x Mode

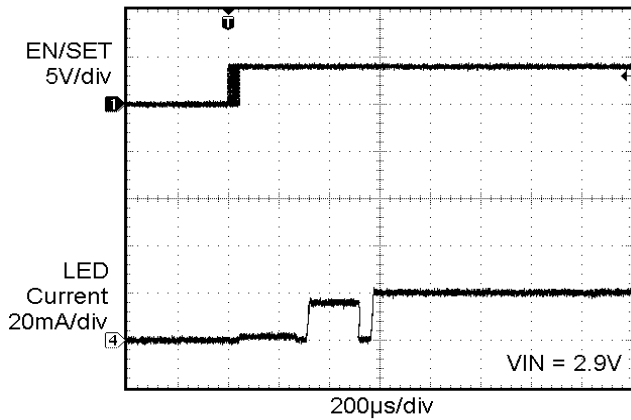

Figure 12. Power Up in 1.5x Mode

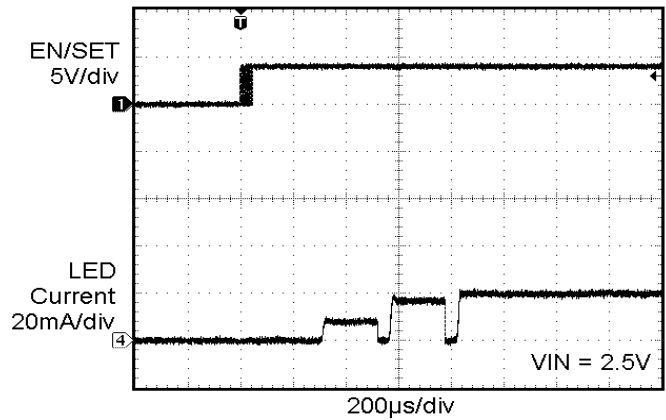

Figure 13. Power Up in 2x Mode

TYPICAL PERFORMANCE CHARACTERISTICS

($V_{IN} = 3.6\text{ V}$, $I_{OUT} = 120\text{ mA}$ (6 LEDs at 20 mA), $C_{IN} = C_{OUT} = C_1 = C_2 = 1\ \mu\text{F}$, $T_{AMB} = 25^\circ\text{C}$ unless otherwise specified.)

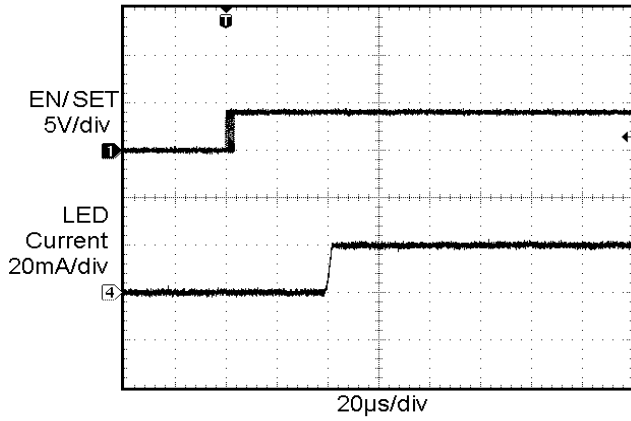

Figure 14. Power Up Delay (1x Mode)

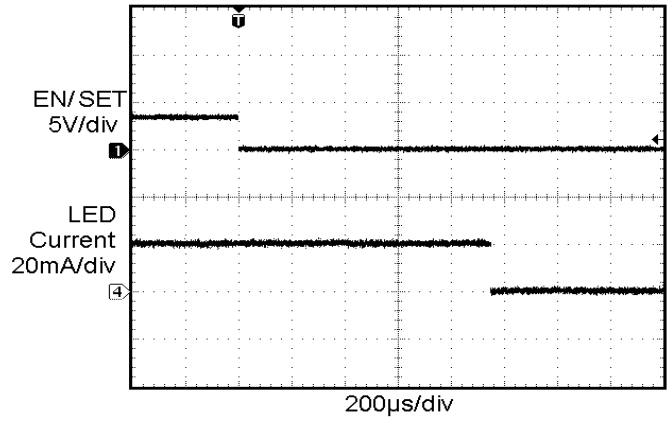

Figure 15. Power Down Delay (1x Mode)

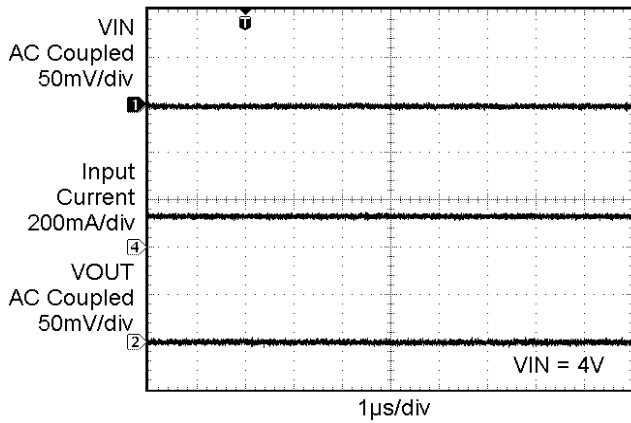

Figure 16. Operating Waveforms in 1x Mode

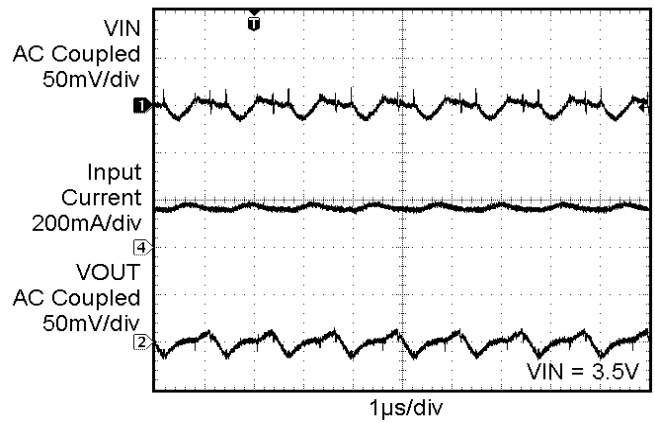

Figure 17. Switching Waveforms in 1.33x Mode

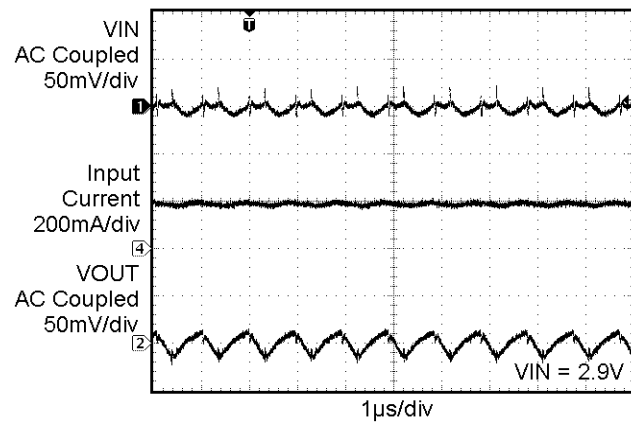

Figure 18. Switching Waveforms in 1.5x Mode

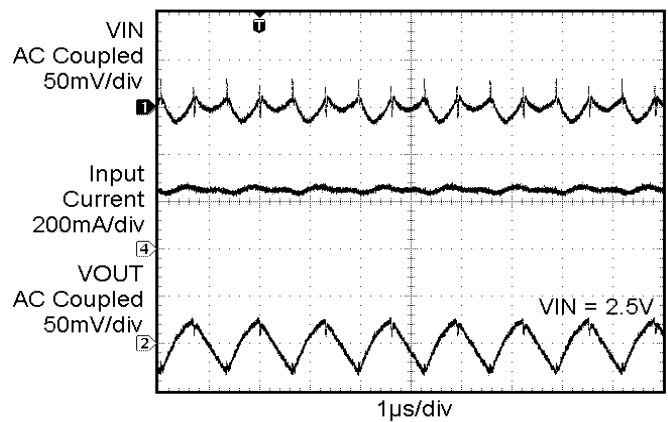

Figure 19. Switching Waveforms in 2x Mode

TYPICAL PERFORMANCE CHARACTERISTICS

($V_{IN} = 3.6\text{ V}$, $I_{OUT} = 120\text{ mA}$ (6 LEDs at 20 mA), $C_{IN} = C_{OUT} = C_1 = C_2 = 1\ \mu\text{F}$, $T_{AMB} = 25^\circ\text{C}$ unless otherwise specified.)

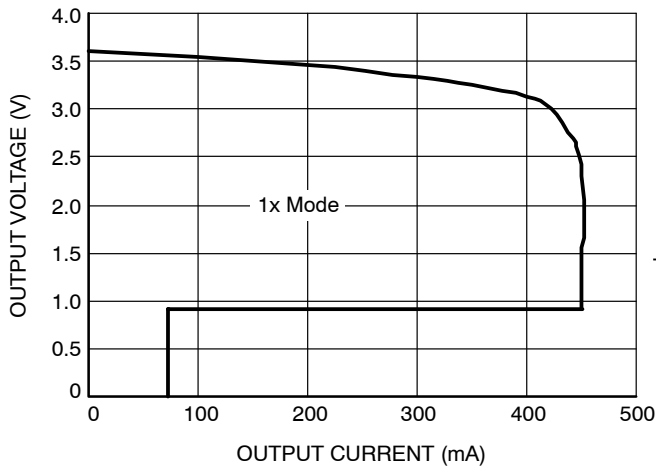

Figure 20. Foldback Current Limit

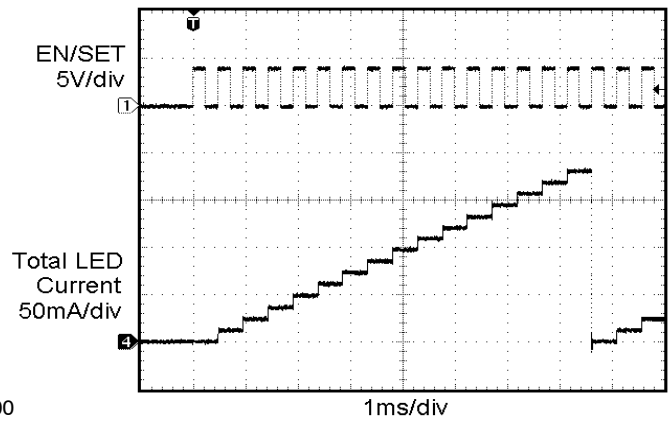

Figure 21. LED Brightness Levels

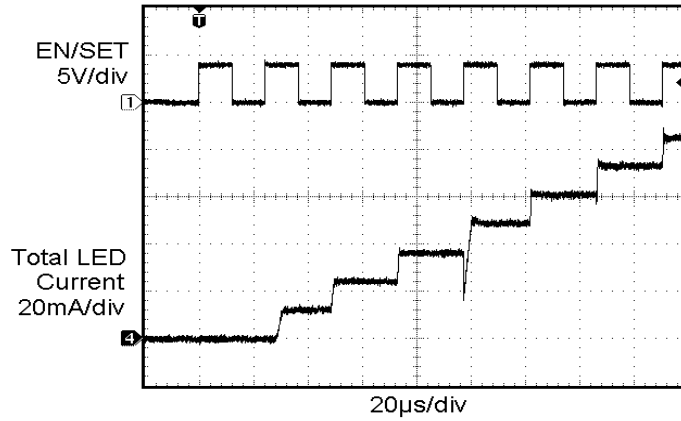

Figure 22. LED Settling Time

Table 5. PIN DESCRIPTION

| Pin # | Name | Function |
|-------|--------|--|
| 1 | LED6 | LED6 cathode terminal |
| 2 | LED5 | LED5 cathode terminal |
| 3 | LED4 | LED4 cathode terminal |
| 4 | LED3 | LED3 cathode terminal |
| 5 | LED2 | LED2 cathode terminal |
| 6 | LED1 | LED1 cathode terminal |
| 7 | VOUT | Charge pump output, connect to LED anodes |
| 8 | VIN | Charge pump input, connect to battery or supply |
| 9 | C1+ | Bucket capacitor 1, positive terminal |
| 10 | C1- | Bucket capacitor 1, negative terminal |
| 11 | C2+ | Bucket capacitor 2, positive terminal |
| 12 | C2- | Bucket capacitor 2, negative terminal |
| 13/14 | NC | No connect |
| 15 | GND | Ground reference |
| 16 | EN/SET | Device enable (active high) and 1 wire control input |
| TAB | TAB | Connect to GND on the PCB |

Pin Function

VIN is the supply pin for the charge pump. A small 1 μ F ceramic bypass capacitor is required between the VIN pin and ground near the device. The operating input voltage range is from 2.5 V to 5.5 V. Whenever the input supply falls below the under-voltage threshold (2 V) all the LED channels will be automatically disabled and the device register are reset to default values.

EN/SET is the enable and one wire addressable control logic input for all LED channels. Guaranteed levels of logic high and logic low are set at 1.3 V and 0.4 V respectively. When EN/SET is initially taken high, the device becomes enabled and all LED currents remain at 0 mA. To place the device into zero current mode, the EN/SET pin must be held low for more than 1.5 ms.

VOUT is the charge pump output that is connected to the LED anodes. A small 1 μ F ceramic bypass capacitor is required between the VOUT pin and ground near the device.

GND is the ground reference for the charge pump. The pin must be connected to the ground plane on the PCB.

C1+, C1- are connected to each side of the ceramic bucket capacitor C1.

C2+, C2- are connected to each side of the ceramic bucket capacitor C2.

LED1 to LED6 provide the internal regulated current for each of the LED cathodes. These pins enter high-impedance zero current state whenever the device is placed in shutdown mode.

TAB is the exposed pad underneath the package. For best thermal performance, the tab should be soldered to the PCB and connected to the ground plane.

Simplified Block Diagram

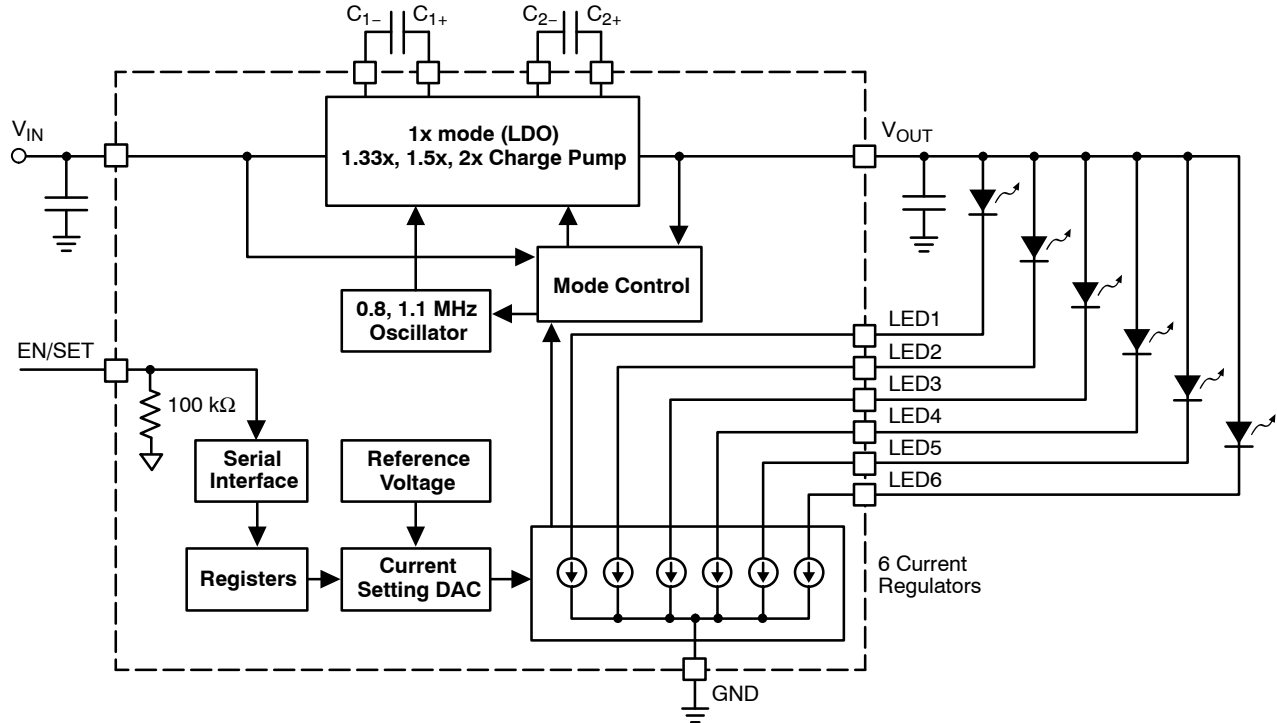

Figure 23. CAT3637 Functional Block Diagram

Basic Operation

At power-up, the CAT3637 starts operating in 1x mode where the output will be approximately equal to the input supply voltage (less any internal voltage losses). If the output voltage is sufficient to regulate all LED currents, the device remains in 1x operating mode.

If the output voltage is insufficient or falls to a level where the regulated current cannot be maintained, the device automatically switches into 1.33x mode (after a fixed delay time of about 120 μs). In 1.33x mode, the output voltage is approximately equal to 1.33 times the input supply voltage (less any internal voltage losses).

If the output voltage is still insufficient or falls to a level where the regulated currents cannot be maintained, the

device will automatically switch to the 1.5x mode (after a fixed delay time of about 400 μs). In 1.5x mode, the output is approximately equal to 1.5 times the input supply voltage (less any internal voltage losses).

If the output voltage is still insufficient to drive the LEDs, it will automatically switch into 2x mode where the output is approximately equal to 2 times the input supply voltage (less any internal voltage losses).

If the device detects a sufficient output voltage to drive all LED currents in 1x mode, it will revert back to 1x mode. This only applies for changing back to the 1x mode.

LED Current Setting

The current in each of the six LED channels is programmed through the 1-wire EN/SET digital control input. At the initial power-up and once the EN/SET is set high, the LED current remains at zero in all channels. On the first EN/SET pulse (positive edge), the current is set to 2 mA in all channels. On each consecutive pulse, the current is incremented by 2 mA. On the 15th pulse, the current is equal to the full scale of 30 mA. On the following pulse (16th pulse), the current goes back to zero and the previous

sequence can be repeated. The EN/SET pin can be pulsed at high frequency 15 times to decrement the current by 2 mA or to program the current from 0 mA to 30 mA. The maximum EN/SET signal frequency for programming the LED current is 2.5 MHz.

To power-down the device and turn-off all current sources, the EN/SET input should be kept low for a duration T_{OFF} of 1.5 ms or more. The driver typically powers-down with a delay of about 1 ms.

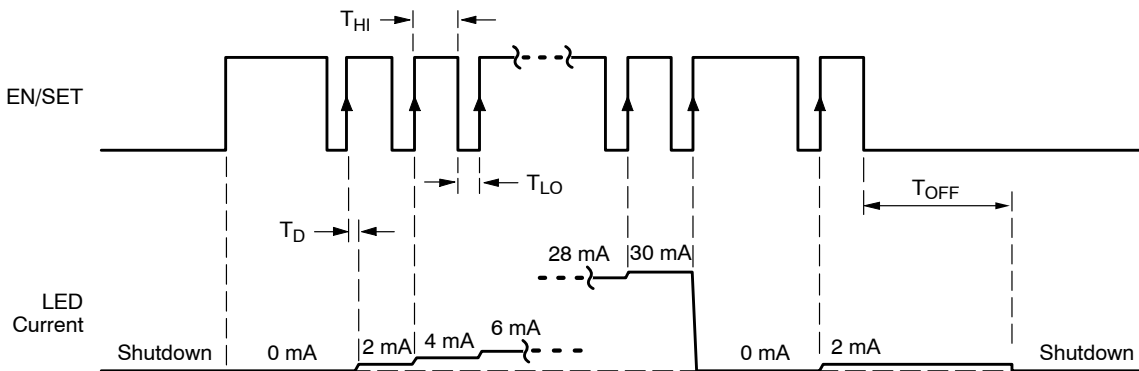

Figure 24. EN/SET One Wire Addressable Timing Diagram

For current increment: $\# \text{ pulses} = \frac{\Delta I}{2}$ For current decrement: $\# \text{ pulses} = 16 - \frac{\Delta I}{2}$

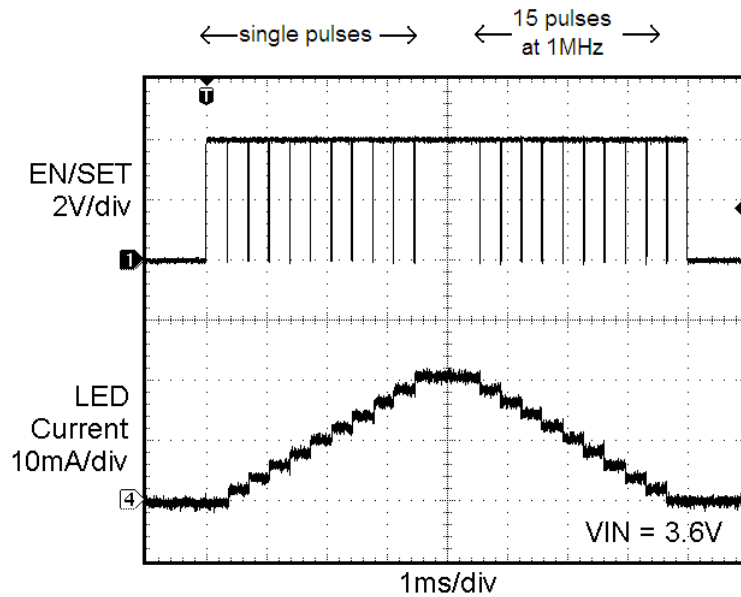

Figure 25. EN/SET Program Increasing / Decreasing LED Current by 2 mA

CAT3637

Unused LED Channels

For applications with 5 LEDs or less, unused LEDs can be disabled by connecting the LED pin directly to VOUT, as shown on Figure 26. If LED pin voltage is within 1 V of

VOUT, then the channel is switched off and a 200 μA test current is placed in the channel to sense when the channel moves below $V_{\text{OUT}} - 1 \text{ V}$.

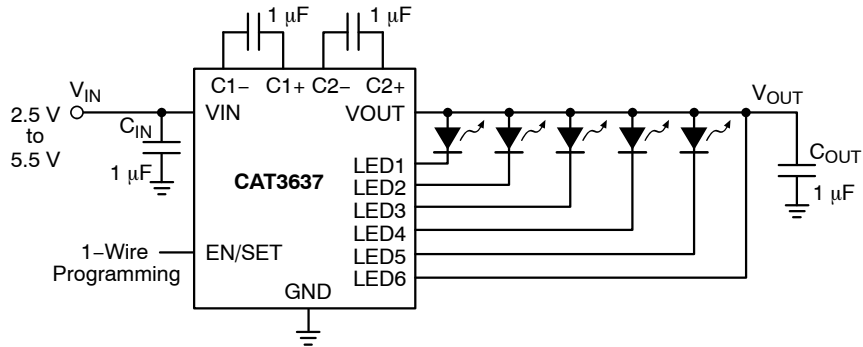

Figure 26. Five LED Application

Protection Mode

If an LED is disconnected, the output voltage VOUT automatically limits at about 5.5 V. This is to prevent the output pin from exceeding its absolute maximum rating.

If the die temperature exceeds +150°C the driver will enter a thermal protection shutdown mode. When the device temperature drops by about 20°C the device will resume normal operation.

LED Selection

LEDs with forward voltages (V_F) ranging from 1.3 V to 5.0 V may be used with the CAT3637. Selecting LEDs with lower V_F is recommended in order to improve the efficiency by keeping the driver in 1x mode longer as the battery voltage decreases.

For example, if a white LED with a V_F of 3.3 V is selected over one with V_F of 3.5 V, the CAT3637 will stay in 1x mode for lower supply voltage of 0.2 V. This helps improve the efficiency and extends battery life.

External Components

The driver requires two external 1 μF ceramic capacitors for decoupling input, output, and for the charge pump. Both capacitors type X5R and X7R are recommended for the LED driver application. In all charge pump modes, the input current ripple is kept very low by design and an input bypass capacitor of 1 μF is sufficient.

In 1x mode, the device operates in linear mode and does not introduce switching noise back onto the supply.

Recommended Layout

In charge pump mode, the driver switches internally at a high frequency. It is recommended to minimize trace length to all four capacitors. A ground plane should cover the area under the driver IC as well as the bypass capacitors. Short connection to ground on capacitors C_{IN} and C_{OUT} can be implemented with the use of multiple via. A copper area matching the TQFN exposed pad (TAB) must be connected to the ground plane underneath. The use of multiple via improves the package heat dissipation.

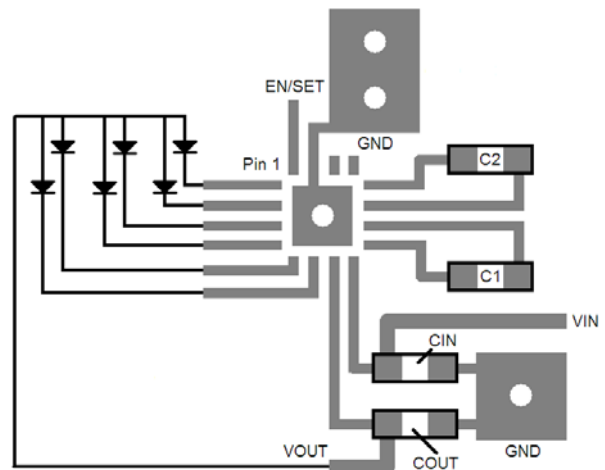
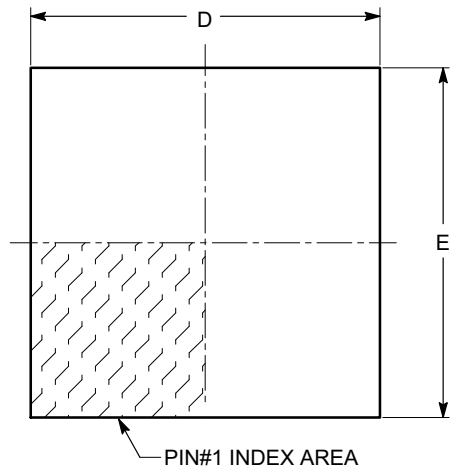

Figure 27. Recommended Layout

CAT3637

PACKAGE DIMENSIONS

TQFN16, 3x3
CASE 510AD
ISSUE A



TOP VIEW

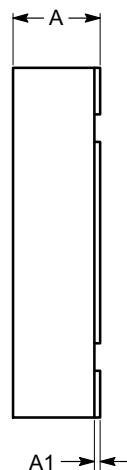

SIDE VIEW

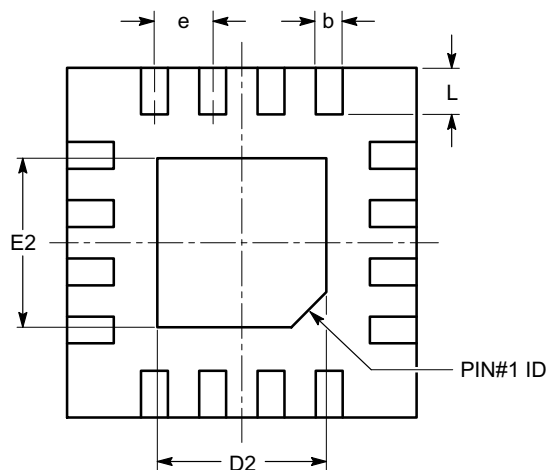

BOTTOM VIEW

| SYMBOL | MIN | NOM | MAX |
|--------|----------|------|------|
| A | 0.70 | 0.75 | 0.80 |
| A1 | 0.00 | 0.02 | 0.05 |
| A3 | 0.20 REF | | |
| b | 0.18 | 0.25 | 0.30 |
| D | 2.90 | 3.00 | 3.10 |
| D2 | 1.40 | --- | 1.80 |
| E | 2.90 | 3.00 | 3.10 |
| E2 | 1.40 | --- | 1.80 |
| e | 0.50 BSC | | |
| L | 0.30 | 0.40 | 0.50 |

Notes:

- (1) All dimensions are in millimeters.
- (2) Complies with JEDEC MO-220.
3. All packages are RoHS-compliant (Pb-Free, Halogen-Free).
4. The standard lead finish is NiPdAu.
5. For additional package and temperature options, please contact your nearest ON Semiconductor Sales office.

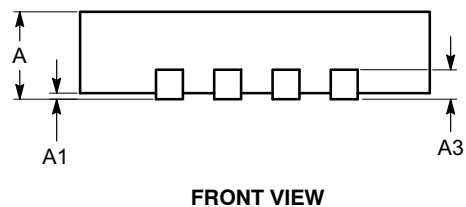

FRONT VIEW

ON Semiconductor and the are registered trademarks of Semiconductor Components Industries, LLC (SCILLC) or its subsidiaries in the United States and/or other countries. SCILLC owns the rights to a number of patents, trademarks, copyrights, trade secrets, and other intellectual property. A listing of SCILLC's product/patent coverage may be accessed at www.onsemi.com/site/pdf/Patent-Marking.pdf. SCILLC reserves the right to make changes without further notice to any products herein. SCILLC makes no warranty, representation or guarantee regarding the suitability of its products for any particular purpose, nor does SCILLC assume any liability arising out of the application or use of any product or circuit, and specifically disclaims any and all liability, including without limitation special, consequential or incidental damages. "Typical" parameters which may be provided in SCILLC data sheets and/or specifications can and do vary in different applications and actual performance may vary over time. All operating parameters, including "Typicals" must be validated for each customer application by customer's technical experts. SCILLC does not convey any license under its patent rights nor the rights of others. SCILLC products are not designed, intended, or authorized for use as components in systems intended for surgical implant into the body, or other applications intended to support or sustain life, or for any other application in which the failure of the SCILLC product could create a situation where personal injury or death may occur. Should Buyer purchase or use SCILLC products for any such unintended or unauthorized application, Buyer shall indemnify and hold SCILLC and its officers, employees, subsidiaries, affiliates, and distributors harmless against all claims, costs, damages, and expenses, and reasonable attorney fees arising out of, directly or indirectly, any claim of personal injury or death associated with such unintended or unauthorized use, even if such claim alleges that SCILLC was negligent regarding the design or manufacture of the part. SCILLC is an Equal Opportunity/Affirmative Action Employer. This literature is subject to all applicable copyright laws and is not for resale in any manner.

PUBLICATION ORDERING INFORMATION

LITERATURE FULFILLMENT:
Literature Distribution Center for ON Semiconductor
P.O. Box 5163, Denver, Colorado 80217 USA
Phone: 303-675-2175 or 800-344-3860 Toll Free USA/Canada
Fax: 303-675-2176 or 800-344-3867 Toll Free USA/Canada
Email: orderlit@onsemi.com

N. American Technical Support: 800-282-9855 Toll Free
USA/Canada
Europe, Middle East and Africa Technical Support:
Phone: 421 33 790 2910
Japan Customer Focus Center
Phone: 81-3-5817-1050

ON Semiconductor Website: www.onsemi.com
Order Literature: <http://www.onsemi.com/orderlit>
For additional information, please contact your local Sales Representative

Looking for pricing, stock, or lifecycle information?

Click below to explore more details on WIN SOURCE:

 [View CAT3637HV3-GT2 on WIN SOURCE](#)

 [ON Semiconductor](#) Information

Optimize Your Supply Chain with WIN SOURCE Solutions

-  Global Sourcing Solution
-  Obsolete Management
-  Cost Control Management
-  Shortage Management
-  Alternative Solution
-  Excess Inventory Management