



**THE DATASHEET OF  
CAT1023WI-42**



# CAT1021, CAT1022, CAT1023



ON Semiconductor®

[www.onsemi.com](http://www.onsemi.com)

## Supervisory Circuits with EEPROM Serial 2k-bit I<sup>2</sup>C Manual Reset and Watchdog Timer

### Description

The CAT1021, CAT1022 and CAT1023 are complete memory and supervisory solutions for microcontroller-based systems. A EEPROM Serial 2k-bit I<sup>2</sup>C memory and a system power supervisor with brown-out protection are integrated together in low power CMOS technology. Memory interface is via a 400 kHz I<sup>2</sup>C bus.

The CAT1021 and CAT1023 provide a precision V<sub>cc</sub> sense circuit and two open drain outputs: one (RESET) drives high and the other ( $\overline{\text{RESET}}$ ) drives low whenever V<sub>cc</sub> falls below the reset threshold voltage. The CAT1022 has only a  $\overline{\text{RESET}}$  output and does not have a Write Protect input. The CAT1021 also has a Write Protect input (WP). Write operations are disabled if WP is connected to a logic high.

All supervisors have a 1.6 second watchdog timer circuit that resets a system to a known state if software or a hardware glitch halts or “hangs” the system. For the CAT1021 and CAT1022, the watchdog timer monitors the SDA signal. The CAT1023 has a separate watchdog timer interrupt input pin, WDI.

The power supply monitor and reset circuit protect memory and system controllers during power up/down and against brownout conditions. Five reset threshold voltages support 5 V, 3.3 V and 3 V systems. If power supply voltages are out of tolerance reset signals become active, preventing the system microcontroller, ASIC or peripherals from operating. Reset signals become inactive typically 200 ms after the supply voltage exceeds the reset threshold level. With both active high and low reset signals, interface to microcontrollers and other ICs is simple. In addition, the RESET pin or a separate input,  $\overline{\text{MR}}$ , can be used as an input for push-button manual reset capability.

The on-chip, 2k-bit EEPROM memory features a 16-byte page. In addition, hardware data protection is provided by a V<sub>cc</sub> sense circuit that prevents writes to memory whenever V<sub>cc</sub> falls below the reset threshold or until V<sub>cc</sub> reaches the reset threshold during power up.

Available packages include an surface mount 8-pin SOIC, 8-pin TSSOP, 8-pin TDFN and 8-pin MSOP packages. The TDFN package thickness is 0.8 mm maximum. TDFN footprint options are 3 x 3 mm.

### Features

- Precision Power Supply Voltage Monitor
  - ◆ 5 V, 3.3 V and 3 V Systems
  - ◆ Five Threshold Voltage Options
- Watchdog Timer
- Active High or Low Reset
  - ◆ Valid Reset Guaranteed at V<sub>cc</sub> = 1 V
- 400 kHz I<sup>2</sup>C Bus
- 2.7 V to 5.5 V Operation
- Low Power CMOS Technology
- 16-Byte Page Write Buffer
- Built-in Inadvertent Write Protection
  - ◆ WP Pin (CAT1021)
- 1,000,000 Program/Erase Cycles
- Manual Reset Input
- 100 Year Data Retention
- Industrial and Extended Temperature Ranges
- 8-pin SOIC, TSSOP, MSOP or TDFN (3 x 3 mm Foot-print) Packages
  - ◆ TDFN Max Height is 0.8 mm
- These Devices are Pb-Free, Halogen Free/BFR Free and are RoHS Compliant

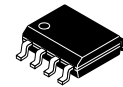

SOIC-8  
CASE 751BD

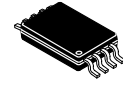

TSSOP-8  
CASE 948S

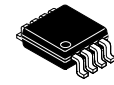

MSOP-8  
CASE 846AD

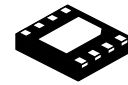

TDFN-8  
CASE 511AL

### ORDERING INFORMATION

For Ordering Information details, see page 13.

# CAT1021, CAT1022, CAT1023

**Table 1. THRESHOLD VOLTAGE OPTION**

Part Dash Number	Minimum Threshold	Maximum Threshold
-45	4.50	4.75
-42	4.25	4.50
-30	3.00	3.15
-28	2.85	3.00
-25	2.55	2.70

## BLOCK DIAGRAM

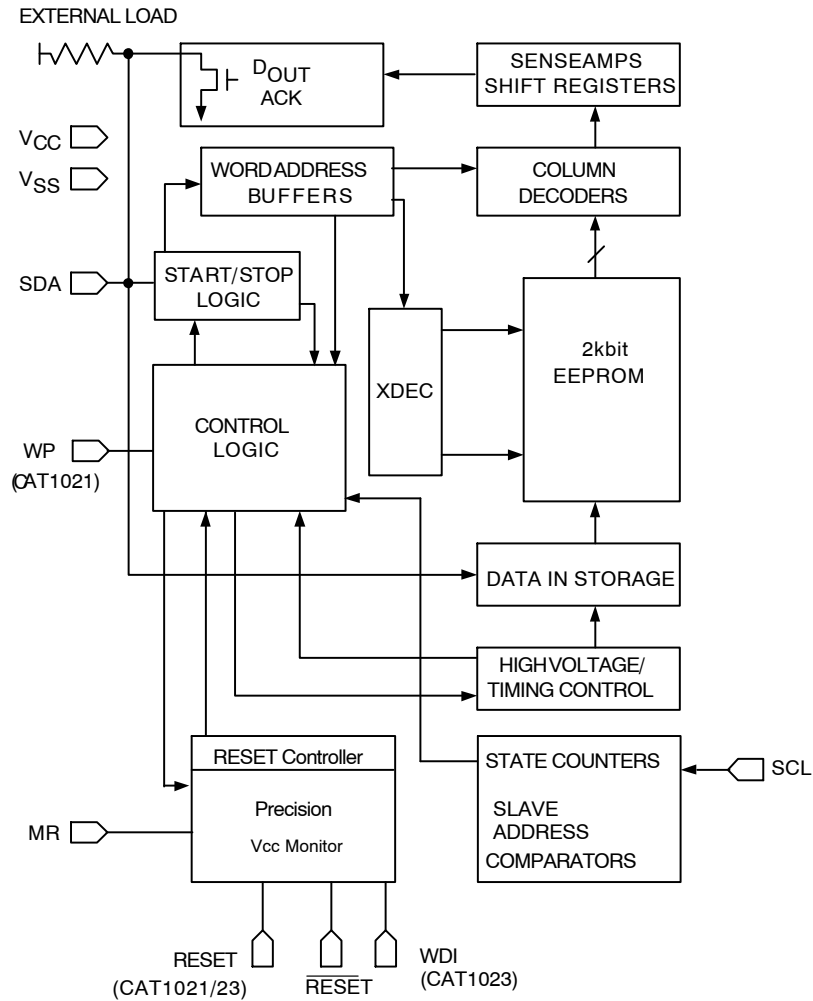

# CAT1021, CAT1022, CAT1023

## PIN CONFIGURATION

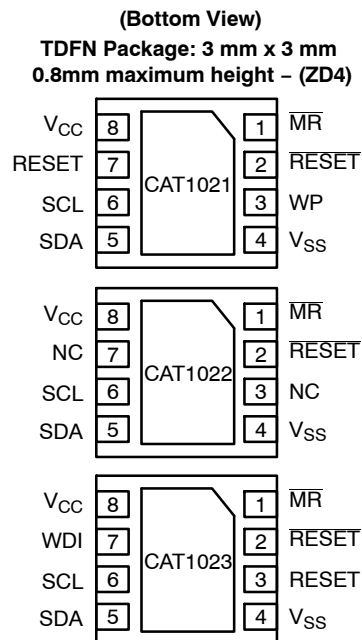
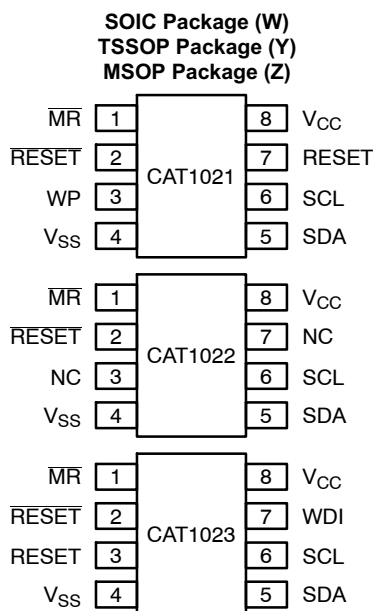

### PIN DESCRIPTION

**RESET/RESET:** RESET OUTPUT  
(RESET CAT1021/23 Only)

These are open drain pins and  $\overline{\text{RESET}}$  can be used as a manual reset trigger input. By forcing a reset condition on the pin the device will initiate and maintain a reset condition. The RESET pin must be connected through a pull-down resistor, and the  $\overline{\text{RESET}}$  pin must be connected through a pull-up resistor.

**SDA:** SERIAL DATA ADDRESS

The bidirectional serial data/address pin is used to transfer all data into and out of the device. The SDA pin is an open drain output and can be wire-ORed with other open drain or open collector outputs.

**SCL:** SERIAL CLOCK

Serial clock input.

**MR:** MANUAL RESET INPUT

Manual Reset input is a debounced input that can be connected to an external source for Manual Reset. Pulling the MR input low will generate a Reset condition. Reset outputs are active while MR input is low and for the reset timeout period after MR returns to high. The input has an internal pull up resistor.

**WP (CAT1021 Only):** WRITE PROTECT INPUT

When WP input is tied to Vss or left unconnected write operations to the entire array are allowed. When tied to Vcc, the entire array is protected. This input has an internal pull down resistor.

**WDI (CAT1023 Only):** WATCHDOG TIMER INTERRUPT

Watchdog Timer Interrupt Input is used to reset the watchdog timer. If a transition from high to low or low to high does not occur every 1.6 seconds, the RESET outputs will be driven active.

**Table 2. PIN FUNCTION**

Pin Name	Function
NC	No Connect
$\overline{\text{RESET}}$	Active Low Reset Input/Output
Vss	Ground
SDA	Serial Data/Address
SCL	Clock Input
RESET	Active High Reset Output (CAT1021/23)
Vcc	Power Supply
WP	Write Protect (CAT1021 Only)
MR	Manual Reset Input
WDI	Watchdog Timer Interrupt (CAT1023)

**Table 3. OPERATING TEMPERATURE RANGE**

Industrial	-40°C to 85°C
Extended	-40°C to 125°C

# CAT1021, CAT1022, CAT1023

**Table 4. CAT102X FAMILY OVERVIEW**

Device	Manual Reset Input Pin	Watchdog	Watchdog Monitor Pin	Write Protection Pin	Independent Auxiliary Voltage Sense	RESET: Active High and LOW	EEPROM
CAT1021	✓	✓	SDA	✓		✓	2k
CAT1022	✓	✓	SDA				2k
CAT1023	✓	✓	WDI			✓	2k
CAT1024	✓						2k
CAT1025	✓			✓		✓	2k
CAT1026					✓	✓	2k
CAT1027		✓	WDI		✓		2k

NOTE: Device will meet the specifications after thermal equilibrium has been established when mounted in a test socket or printed circuit board with maintained transverse airflow greater than 500 lpm.

## SPECIFICATIONS

**Table 5. ABSOLUTE MAXIMUM RATINGS**

Parameters	Ratings	Units
Temperature Under Bias	-55 to +125	°C
Storage Temperature	-65 to +150	°C
Voltage on any Pin with Respect to Ground (Note 1)	-2.0 to $V_{CC} + 2.0$	V
$V_{CC}$ with Respect to Ground	-2.0 to 7.0	V
Package Power Dissipation Capability ( $T_A = 25^\circ\text{C}$ )	1.0	W
Lead Soldering Temperature (10 s)	300	°C
Output Short Circuit Current (Note 2)	100	mA

Stresses exceeding those listed in the Maximum Ratings table may damage the device. If any of these limits are exceeded, device functionality should not be assumed, damage may occur and reliability may be affected.

- The minimum DC input voltage is -0.5 V. During transitions, inputs may undershoot to -2.0 V for periods of less than 20 ns. Maximum DC voltage on output pins is  $V_{CC} + 0.5$  V, which may overshoot to  $V_{CC} + 2.0$  V for periods of less than 20 ns.
- Output shorted for no more than one second. No more than one output shorted at a time.

**Table 6. D.C. OPERATING CHARACTERISTICS**

$V_{CC} = 2.7$  V to 5.5 V and over the recommended temperature conditions unless otherwise specified.

Symbol	Parameter	Test Conditions	Min	Typ	Max	Units
$I_{LI}$	Input Leakage Current	$V_{IN} = \text{GND to } V_{CC}$	-2		10	$\mu\text{A}$
$I_{LO}$	Output Leakage Current	$V_{IN} = \text{GND to } V_{CC}$	-10		10	$\mu\text{A}$
$I_{CC1}$	Power Supply Current (Write)	$f_{SCL} = 400$ kHz $V_{CC} = 5.5$ V			3	mA
$I_{CC2}$	Power Supply Current (Read)	$f_{SCL} = 400$ kHz $V_{CC} = 5.5$ V			1	mA
$I_{SB}$	Standby Current	$V_{CC} = 5.5$ V $V_{IN} = \text{GND to } V_{CC}$			60	$\mu\text{A}$
$V_{IL}$ (Note 3)	Input Low Voltage		-0.5		$0.3 \times V_{CC}$	V
$V_{IH}$ (Note 3)	Input High Voltage		$0.7 \times V_{CC}$		$V_{CC} + 0.5$	V
$V_{OL}$	Output Low Voltage (SDA, RESET)	$I_{OL} = 3$ mA $V_{CC} = 2.7$ V			0.4	V
$V_{OH}$	Output High Voltage (RESET)	$I_{OH} = -0.4$ mA $V_{CC} = 2.7$ V	$V_{CC} - 0.75$			V

# CAT1021, CAT1022, CAT1023

**Table 6. D.C. OPERATING CHARACTERISTICS**

$V_{CC} = 2.7\text{ V to }5.5\text{ V}$  and over the recommended temperature conditions unless otherwise specified.

Symbol	Parameter	Test Conditions	Min	Typ	Max	Units
$V_{TH}$	Reset Threshold	CAT102x-45 ( $V_{CC} = 5.0\text{ V}$ )	4.50		4.75	V
		CAT102x-42 ( $V_{CC} = 5.0\text{ V}$ )	4.25		4.50	
		CAT102x-30 ( $V_{CC} = 3.3\text{ V}$ )	3.00		3.15	
		CAT102x-28 ( $V_{CC} = 3.3\text{ V}$ )	2.85		3.00	
		CAT102x-25 ( $V_{CC} = 3.0\text{ V}$ )	2.55		2.70	
$V_{RVALID}$	Reset Output Valid $V_{CC}$ Voltage		1.00			V
$V_{RT}$ (Note 4)	Reset Threshold Hysteresis		15			mV

- $V_{IL}$  min and  $V_{IH}$  max are reference values only and are not tested.
- This parameter is tested initially and after a design or process change that affects the parameter. Not 100% tested.

**Table 7. CAPACITANCE**

$T_A = 25^\circ\text{C}$ ,  $f = 1.0\text{ MHz}$ ,  $V_{CC} = 5\text{ V}$

Symbol	Test	Test Conditions	Max	Units
$C_{OUT}$ (Note 5)	Output Capacitance	$V_{OUT} = 0\text{ V}$	8	pF
$C_{IN}$ (Note 5)	Input Capacitance	$V_{IN} = 0\text{ V}$	6	pF

**Table 8. AC CHARACTERISTICS**

$V_{CC} = 2.7\text{ V to }5.5\text{ V}$  and over the recommended temperature conditions, unless otherwise specified.

**Memory Read & Write Cycle** (Note 6)

Symbol	Parameter	Min	Max	Units
$f_{SCL}$	Clock Frequency		400	kHz
$t_{SP}$	Input Filter Spike Suppression (SDA, SCL)		100	ns
$t_{LOW}$	Clock Low Period	1.3		$\mu\text{s}$
$t_{HIGH}$	Clock High Period	0.6		$\mu\text{s}$
$t_R$ (Note 5)	SDA and SCL Rise Time		300	ns
$t_F$ (Note 5)	SDA and SCL Fall Time		300	ns
$t_{HD; STA}$	Start Condition Hold Time	0.6		$\mu\text{s}$
$t_{SU; STA}$	Start Condition Setup Time (for a Repeated Start)	0.6		$\mu\text{s}$
$t_{HD; DAT}$	Data Input Hold Time	0		ns
$t_{SU; DAT}$	Data Input Setup Time	100		ns
$t_{SU; STO}$	Stop Condition Setup Time	0.6		$\mu\text{s}$
$t_{AA}$	SCL Low to Data Out Valid		900	ns
$t_{DH}$	Data Out Hold Time	50		ns
$t_{BUF}$ (Note 5)	Time the Bus must be Free Before a New Transmission Can Start	1.3		$\mu\text{s}$
$t_{WC}$ (Note 7)	Write Cycle Time (Byte or Page)		5	ms

- This parameter is characterized initially and after a design or process change that affects the parameter. Not 100% tested.
- Test Conditions according to "AC Test Conditions" table.
- The write cycle time is the time from a valid stop condition of a write sequence to the end of the internal program/erase cycle. During the write cycle, the bus interface circuits are disabled, SDA is allowed to remain high and the device does not respond to its slave address.

# CAT1021, CAT1022, CAT1023

**Table 9. RESET CIRCUIT AC CHARACTERISTICS**

Symbol	Parameter	Test Conditions	Min	Typ	Max	Units
$t_{PURST}$	Power-Up Reset Timeout	Note 2	130	200	270	ms
$t_{RDP}$	$V_{TH}$ to RESET output Delay	Note 3			5	$\mu$ s
$t_{GLITCH}$	$V_{CC}$ Glitch Reject Pulse Width	Notes 4 and 5			30	ns
MR Glitch	Manual Reset Glitch Immunity	Note 1			100	ns
$t_{MRW}$	MR Pulse Width	Note 1	5			$\mu$ s
$t_{MRD}$	MR Input to RESET Output Delay	Note 1			1	$\mu$ s
$t_{WD}$	Watchdog Timeout	Note 1	1.0	1.6	2.1	sec

**Table 10. POWER-UP TIMING** (Notes 5 and 6)

Symbol	Parameter	Test Conditions	Min	Typ	Max	Units
$t_{PUR}$	Power-Up to Read Operation				270	ms
$t_{PUW}$	Power-Up to Write Operation				270	ms

**Table 11. AC TEST CONDITIONS**

Parameter	Test Conditions
Input Pulse Voltages	$0.2 \times V_{CC}$ to $0.8 \times V_{CC}$
Input Rise and Fall Times	10 ns
Input Reference Voltages	$0.3 \times V_{CC}$ , $0.7 \times V_{CC}$
Output Reference Voltages	$0.5 \times V_{CC}$
Output Load	Current Source: $I_{OL} = 3$ mA; $C_L = 100$ pF

**Table 12. RELIABILITY CHARACTERISTICS**

Symbol	Parameter	Reference Test Method	Min	Max	Units
$N_{END}$ (Note 5)	Endurance	MIL-STD-883, Test Method 1033	1,000,000		Cycles/Byte
$T_{DR}$ (Note 5)	Data Retention	MIL-STD-883, Test Method 1008	100		Years
$V_{ZAP}$ (Note 5)	ESD Susceptibility	MIL-STD-883, Test Method 3015	2000		Volts
$I_{LTH}$ (Notes 5 & 7)	Latch-Up	JEDEC Standard 17	100		mA

1. Test Conditions according to "AC Test Conditions" table.
2. Power-up, Input Reference Voltage  $V_{CC} = V_{TH}$ , Reset Output Reference Voltage and Load according to "AC Test Conditions" Table
3. Power-Down, Input Reference Voltage  $V_{CC} = V_{TH}$ , Reset Output Reference Voltage and Load according to "AC Test Conditions" Table
4.  $V_{CC}$  Glitch Reference Voltage =  $V_{THmin}$ ; Based on characterization data
5. This parameter is characterized initially and after a design or process change that affects the parameter. Not 100% tested.
6.  $t_{PUR}$  and  $t_{PUW}$  are the delays required from the time  $V_{CC}$  is stable until the specified memory operation can be initiated.
7. Latch-up protection is provided for stresses up to 100 mA on input and output pins from  $-1$  V to  $V_{CC} + 1$  V.

## DEVICE OPERATON

### Reset Controller Description

The CAT1021/22/23 precision RESET controllers ensure correct system operation during brownout and power up/down conditions. They are configured with open drain RESET outputs.

During power-up, the RESET outputs remain active until  $V_{CC}$  reaches the  $V_{TH}$  threshold and will continue driving the outputs for approximately 200 ms ( $t_{PURST}$ ) after reaching  $V_{TH}$ . After the  $t_{PURST}$  timeout interval, the device will cease to drive the reset outputs. At this point the reset outputs will be pulled up or down by their respective pull up/down resistors.

During power-down, the RESET outputs will be active when  $V_{CC}$  falls below  $V_{TH}$ . The  $\overline{RESET}$  output will be valid so long as  $V_{CC}$  is  $>1.0$  V ( $V_{RVALID}$ ). The device is designed to ignore the fast negative going  $V_{CC}$  transient pulses (glitches).

Reset output timing is shown in Figure 1.

### Manual Reset Operation

The  $\overline{RESET}$  pin can operate as reset output and manual reset input. The input is edge triggered; that is, the  $\overline{RESET}$  input will initiate a reset timeout after detecting a high to low transition.

When  $\overline{RESET}$  I/O is driven to the active state, the 200 ms timer will begin to time the reset interval. If external reset is shorter than 200 ms, Reset outputs will remain active at least 200 ms.

The CAT1021/22/23 also have a separate manual reset input. Driving the  $\overline{MR}$  input low by connecting a pushbutton (normally open) from  $\overline{MR}$  pin to GND will generate a reset condition. The input has an internal pull up resistor.

Reset remains asserted while  $\overline{MR}$  is low and for the Reset Timeout period after  $\overline{MR}$  input has gone high.

Glitches shorter than 100 ns on  $\overline{MR}$  input will not generate a reset pulse. No external debouncing circuits are required. Manual reset operation using  $\overline{MR}$  input is shown in Figure 2.

### Hardware Data Protection

The CAT1021/22/23 supervisors have been designed to solve many of the data corruption issues that have long been associated with serial EEPROMs. Data corruption occurs when incorrect data is stored in a memory location which is assumed to hold correct data.

Whenever the device is in a Reset condition, the embedded EEPROM is disabled for all operations, including write operations. If the Reset output(s) are active, in progress communications to the EEPROM are aborted and no new communications are allowed. In this condition an internal write cycle to the memory can not be started, but an in progress internal nonvolatile memory write cycle can not be aborted. An internal write cycle initiated before the Reset condition can be successfully finished if there is enough time (5ms) before  $V_{CC}$  reaches the minimum value of 2V.

In addition, the CAT1021 includes a Write Protection Input which when tied to  $V_{CC}$  will disable any write operations to the device.

### Watchdog Timer

The Watchdog Timer provides an independent protection for microcontrollers. During a system failure, CAT1021/22/23 devices will provide a reset signal after a time-out interval of 1.6 seconds for a lack of activity. The CAT1023 is designed with the Watchdog timer feature on the WDI pin. The CAT1021 and CAT1022 monitor the SDA line. If WDI or SDA does not toggle within a 1.6 second interval, the reset condition will be generated on the reset outputs. The watchdog timer is cleared by any transition on a monitored line.

As long as reset signal is asserted, the watchdog timer will not count and will stay cleared.

# CAT1021, CAT1022, CAT1023

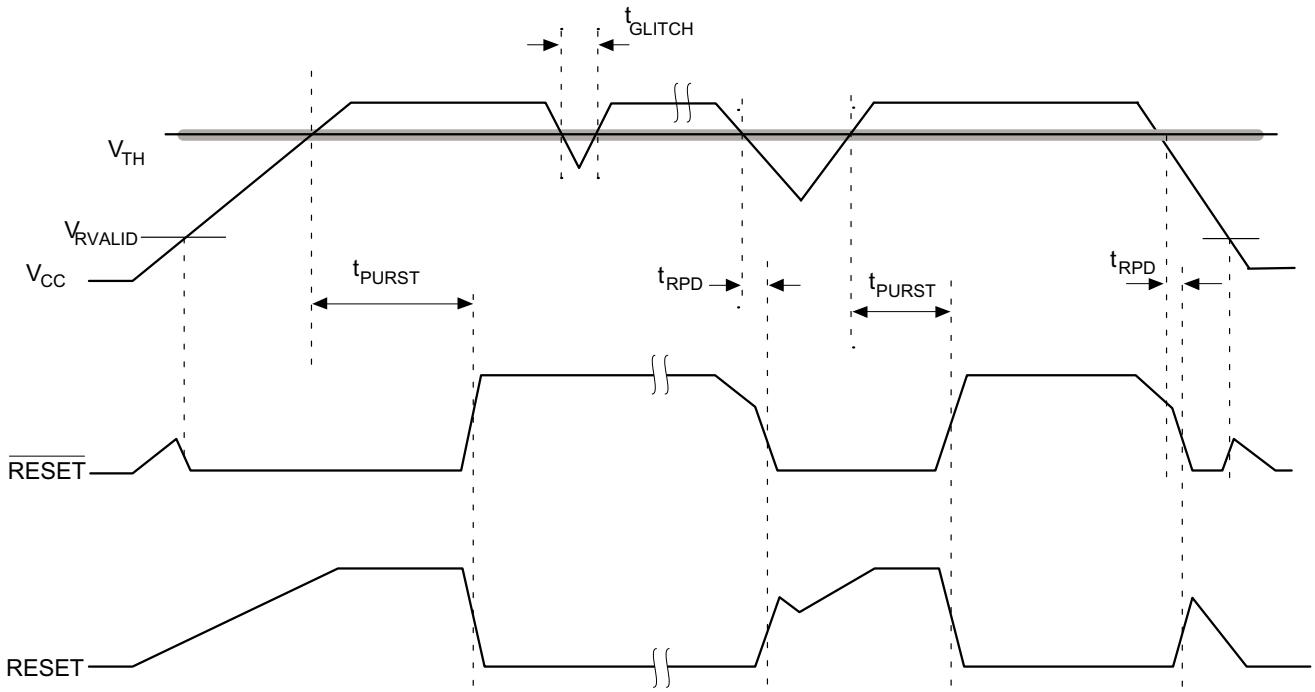

**Figure 1. RESET Output Timing**

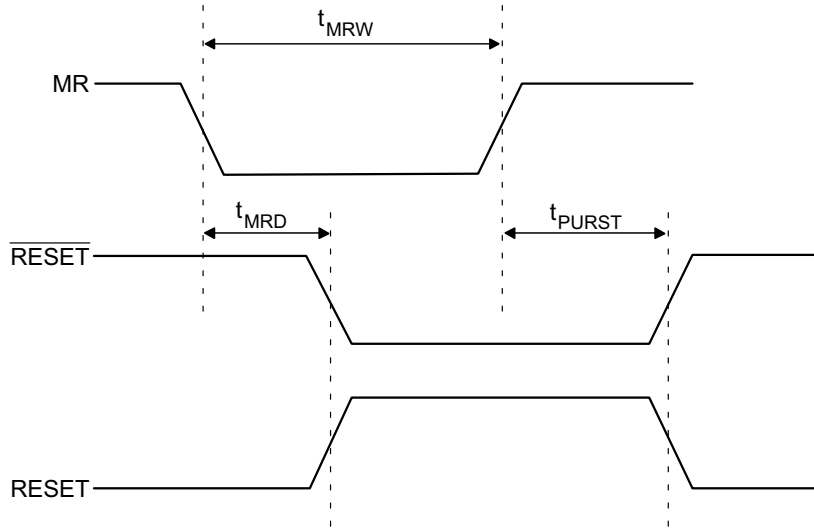

**Figure 2.  $\overline{MR}$  Operation and Timing**

# CAT1021, CAT1022, CAT1023

## EMBEDDED EEPROM OPERATON

The CAT1021/22/23 feature a 2-kbit embedded serial EEPROM that supports the I<sup>2</sup>C Bus data transmission protocol. This Inter-Integrated Circuit Bus protocol defines any device that sends data to the bus to be a transmitter and any device receiving data to be a receiver. The transfer is controlled by the Master device which generates the serial clock and all START and STOP conditions for bus access. Both the Master device and Slave device can operate as either transmitter or receiver, but the Master device controls which mode is activated.

### I<sup>2</sup>C Bus Protocol

The features of the I<sup>2</sup>C bus protocol are defined as follows:

1. Data transfer may be initiated only when the bus is not busy.

2. During a data transfer, the data line must remain stable whenever the clock line is high. Any changes in the data line while the clock line is high will be interpreted as a START or STOP condition.

### Start Condition

The START Condition precedes all commands to the device, and is defined as a HIGH to LOW transition of SDA when SCL is HIGH. The CAT1021/22/23 monitor the SDA and SCL lines and will not respond until this condition is met.

### Stop Condition

A LOW to HIGH transition of SDA when SCL is HIGH determines the STOP condition. All operations must end with a STOP condition.

## DEVICE ADDRESSING

The Master begins a transmission by sending a START condition. The Master sends the address of the particular slave device it is requesting. The four most significant bits of the 8-bit slave address are programmable in metal and the default is 1010.

The last bit of the slave address specifies whether a Read or Write operation is to be performed. When this bit is set to 1, a Read operation is selected, and when set to 0, a Write operation is selected.

After the Master sends a START condition and the slave address byte, the CAT1021/22/23 monitors the bus and responds with an acknowledge (on the SDA line) when its address matches the transmitted slave address. The CAT1021/22/23 then perform a Read or Write operation depending on the R/W bit.

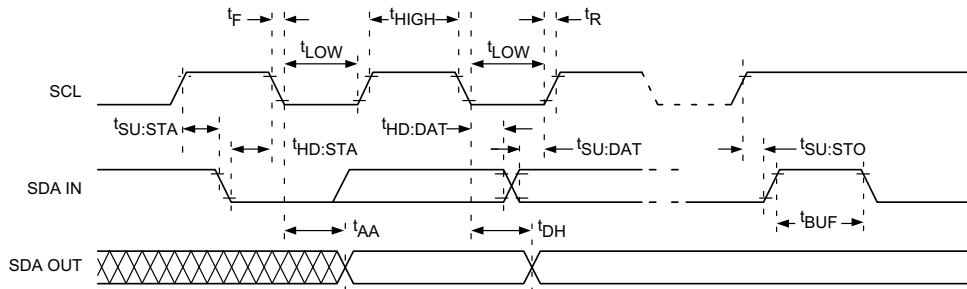

Figure 3. Bus Timing

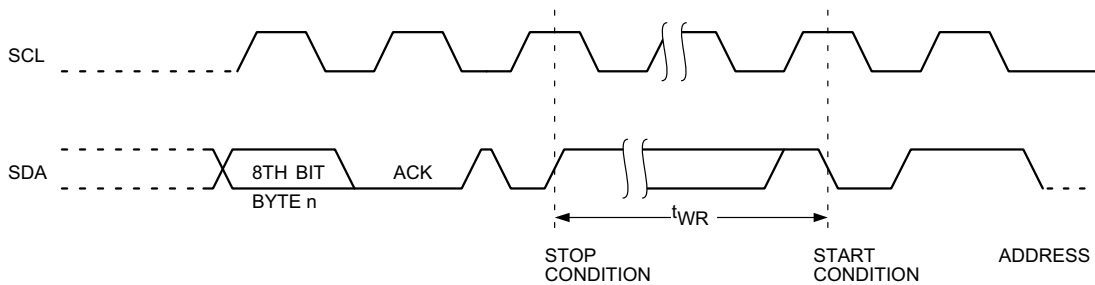

Figure 4. Write Cycle Timing

## ACKNOWLEDGE

After a successful data transfer, each receiving device is required to generate an acknowledge. The acknowledging device pulls down the SDA line during the ninth clock cycle, signaling that it received the 8 bits of data.

All devices respond with an acknowledge after receiving a START condition and its slave address. If the device has been selected along with a write operation, it responds with an acknowledge after receiving each 8-bit byte.

When a device begins a READ mode it transmits 8 bits of data, releases the SDA line and monitors the line for an acknowledge. Once it receives this acknowledge, the device will continue to transmit data. If no acknowledge is sent by the Master, the device terminates data transmission and waits for a STOP condition.

## WRITE OPERATIONS

### Byte Write

In the Byte Write mode, the Master device sends the START condition and the slave address information (with the  $\overline{R/W}$  bit set to zero) to the Slave device. After the Slave generates an acknowledge, the Master sends a 8-bit address that is to be written into the address pointers of the device. After receiving another acknowledge from the Slave, the

Master device transmits the data to be written into the addressed memory location. The device acknowledges once more and the Master generates the STOP condition. At this time, the device begins an internal programming cycle to non-volatile memory. While the cycle is in progress, the device will not respond to any request from the Master device.

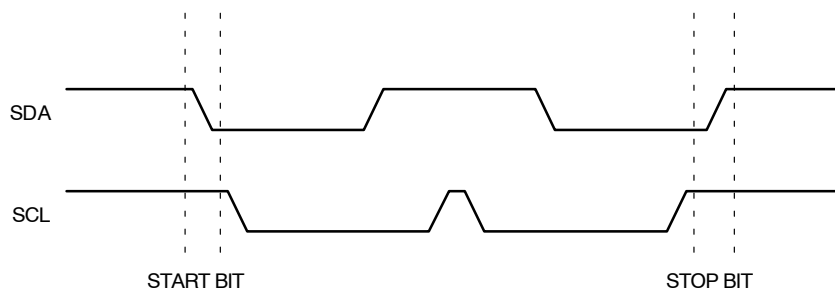

Figure 5. Start/Stop Timing

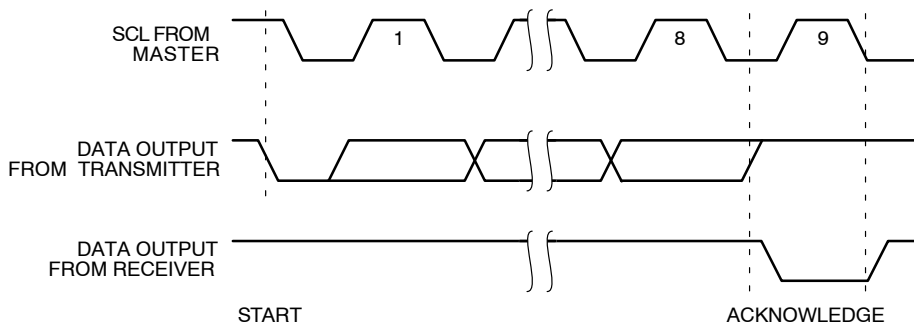

Figure 6. Acknowledge Timing

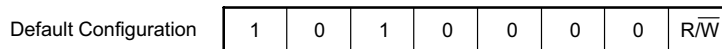

Figure 7. Slave Address Bits

# CAT1021, CAT1022, CAT1023

## Page Write

The CAT1021/22/23 writes up to 16 bytes of data in a single write cycle, using the Page Write operation. The page write operation is initiated in the same manner as the byte write operation, however instead of terminating after the initial byte is transmitted, the Master is allowed to send up to 15 additional bytes. After each byte has been transmitted, the CAT1021/22/23 will respond with an acknowledge and internally increment the lower order address bits by one. The high order bits remain unchanged.

If the Master transmits more than 16 bytes before sending the STOP condition, the address counter ‘wraps around,’ and previously transmitted data will be overwritten.

When all 16 bytes are received, and the STOP condition has been sent by the Master, the internal programming cycle begins. At this point, all received data is written to the CAT1021/22/23 in a single write cycle.

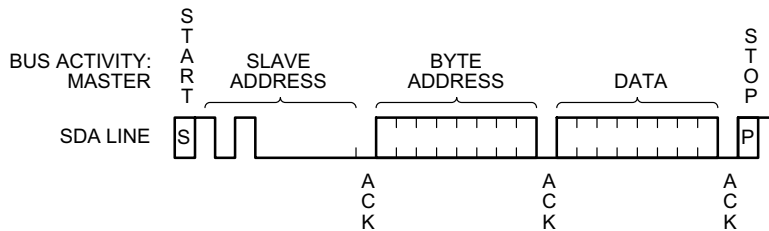

Figure 8. Byte Write Timing

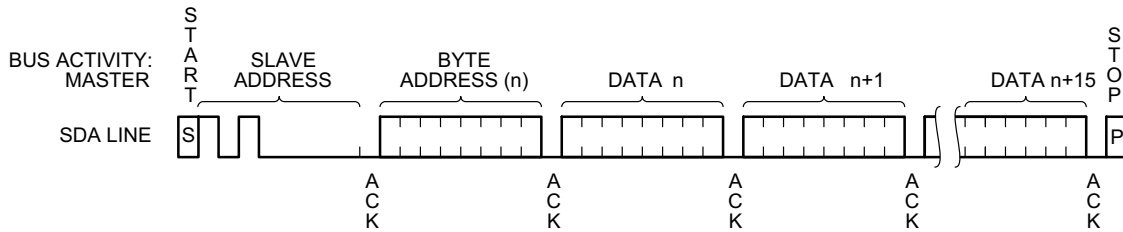

Figure 9. Page Write Timing

## Acknowledge Polling

Disabling of the inputs can be used to take advantage of the typical write cycle time. Once the stop condition is issued to indicate the end of the host’s write operation, the CAT1021/22/23 initiates the internal write cycle. ACK polling can be initiated immediately. This involves issuing

the start condition followed by the slave address for a write operation. If the device is still busy with the write operation, no ACK will be returned. If a write operation has completed, an ACK will be returned and the host can then proceed with the next read or write operation.

## WRITE PROTECTION PIN (WP)

The Write Protection feature (CAT1021 only) allows the user to protect against inadvertent memory array programming. If the WP pin is tied to V<sub>CC</sub>, the entire memory array is protected and becomes read only. The

CAT1021 will accept both slave and byte addresses, but the memory location accessed is protected from programming by the device’s failure to send an acknowledge after the first byte of data is received.

## READ OPERATIONS

The READ operation for the CAT1021/22/23 is initiated in the same manner as the write operation with one exception, the R/W bit is set to one. Three different READ

operations are possible: Immediate/Current Address READ, Selective/Random READ and Sequential READ.

## CAT1021, CAT1022, CAT1023

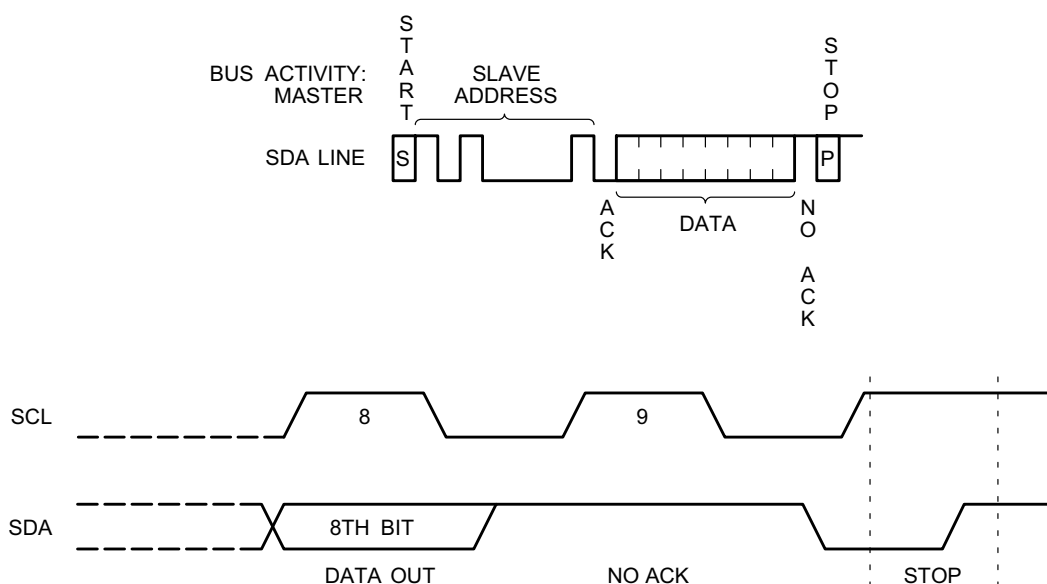

Figure 10. Immediate Address Read Timing

### Immediate/Current Address Read

The CAT1021/22/23 address counter contains the address of the last byte accessed, incremented by one. In other words, if the last READ or WRITE access was to address N, the READ immediately following would access data from address N + 1. For N = E = 255, the counter will wrap around to zero and continue to clock out valid data. After the CAT1021/22/23 receives its slave address information (with the  $R/\overline{W}$  bit set to one), it issues an acknowledge, then transmits the 8-bit byte requested. The master device does not send an acknowledge, but will generate a STOP condition.

### Selective/Random Read

Selective/Random READ operations allow the Master device to select at random any memory location for a READ operation. The Master device first performs a 'dummy' write operation by sending the START condition, slave address and byte addresses of the location it wishes to read. After the CAT1021/22/23 acknowledges, the Master device

sends the START condition and the slave address again, this time with the  $R/\overline{W}$  bit set to one. The CAT1021/22/23 then responds with its acknowledge and sends the 8-bit byte requested. The master device does not send an acknowledge but will generate a STOP condition.

### Sequential Read

The Sequential READ operation can be initiated by either the Immediate Address READ or Selective READ operations. After the CAT1021/22/23 sends the initial 8-bit byte requested, the Master will respond with an acknowledge which tells the device it requires more data. The CAT1021/22/23 will continue to output an 8-bit byte for each acknowledge, thus sending the STOP condition.

The data being transmitted from the CAT1021/22/23 is sent sequentially with the data from address N followed by data from address N + 1. The READ operation address counter increments all of the CAT1021/22/23 address bits so that the entire memory array can be read during one operation.

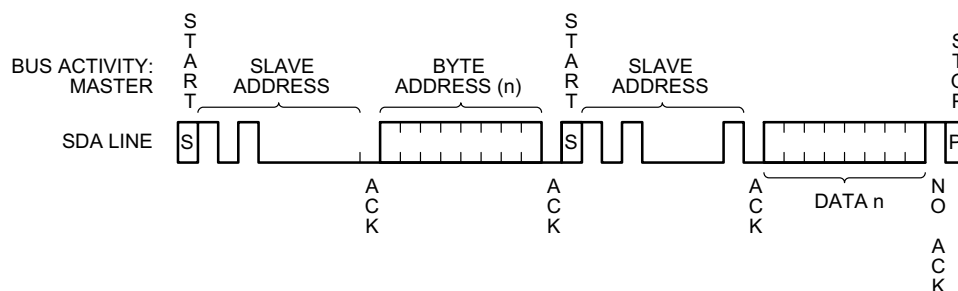
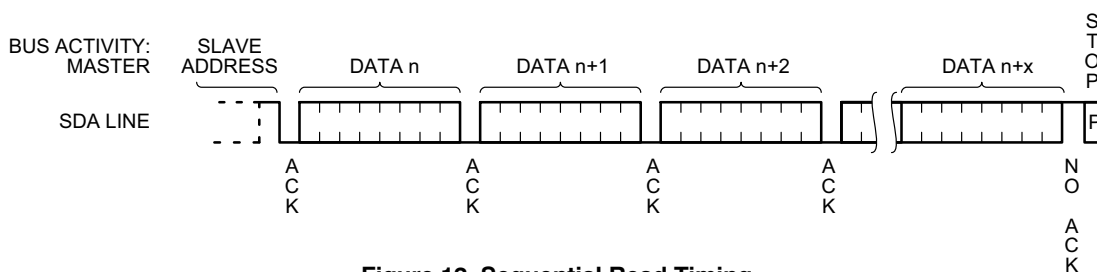

Figure 11. Selective Read Timing

## CAT1021, CAT1022, CAT1023



**Figure 12. Sequential Read Timing**

### ORDERING INFORMATION

Orderable Part Numbers – CAT1021 Series (See Notes 1 – 5)			
Device	Reset Threshold	Package	Shipping†
CAT1021WI-45-GT3	4.50 V – 4.75 V	SOIC	3000 Tape & Reel
CAT1021WI-42-GT3	4.25 V – 4.50 V		
CAT1021WI-30-GT3	3.00 V – 3.15 V		
CAT1021WI-28-GT3	2.85 V – 3.00 V		
CAT1021WI-25-GT3	2.55 V – 2.70 V		
CAT1021YI-45-GT3	4.50 V – 4.75 V	TSSOP	
CAT1021YI-42-GT3	4.25 V – 4.50 V		
CAT1021YI-30-GT3	3.00 V – 3.15 V		
CAT1021YI-28-GT3	2.85 V – 3.00 V		
CAT1021YI-25-GT3	2.55 V – 2.70 V		
CAT1021ZI-45-GT3	4.50 V – 4.75 V	MSOP	
CAT1021ZI-42-GT3	4.25 V – 4.50 V		
CAT1021ZI-30-GT3	3.00 V – 3.15 V		
CAT1021ZI-28-GT3	2.85 V – 3.00 V		
CAT1021ZI-25-GT3	2.55 V – 2.70 V		
CAT1021ZD4I-45T3*	4.50 V – 4.75 V	TDFN	
CAT1021ZD4I-42T3*	4.25 V – 4.50 V		
CAT1021ZD4I-30T3*	3.00 V – 3.15 V		
CAT1021ZD4I-28T3*	2.85 V – 3.00 V		
CAT1021ZD4I-25T3*	2.55 V – 2.70 V		

†For information on tape and reel specifications, including part orientation and tape sizes, please refer to our Tape and Reel Packaging Specifications Brochure, BRD8011/D.

1. All packages are RoHS-compliant (Lead-free, Halogen-free).
2. The standard lead finish is NiPdAu.
3. For additional package and temperature options, please contact your nearest ON Semiconductor Sales office.
4. TDFN not available in NiPdAu (-G) version.
5. For detailed information and a breakdown of device nomenclature and numbering systems, please see the ON Semiconductor Device Nomenclature document, TND310/D, available at [www.onsemi.com](http://www.onsemi.com)

## CAT1021, CAT1022, CAT1023

<b>Orderable Part Numbers – CAT1022 Series</b> (See Notes 1 – 5)			
Device	Reset Threshold	Package	Shipping†
CAT1022WI-45-GT3	4.50 V – 4.75 V	SOIC	3000 Tape & Reel
CAT1022WI-42-GT3	4.25 V – 4.50 V		
CAT1022WI-30-GT3	3.00 V – 3.15 V		
CAT1022WI-28-GT3	2.85 V – 3.00 V		
CAT1022WI-25-GT3	2.55 V – 2.70 V		
CAT1022YI-45-GT3	4.50 V – 4.75 V	TSSOP	
CAT1022YI-42-GT3	4.25 V – 4.50 V		
CAT1022YI-30-GT3	3.00 V – 3.15 V		
CAT1022YI-28-GT3	2.85 V – 3.00 V		
CAT1022YI-25-GT3	2.55 V – 2.70 V		
CAT1022ZI-45-GT3	4.50 V – 4.75 V	MSOP	
CAT1022ZI-30-GT3	3.00 V – 3.15 V		
CAT1022ZI-28-GT3	2.85 V – 3.00 V		
CAT1022ZI-25-GT3	2.55 V – 2.70 V		
CAT1022ZD4I-45T3*	4.50 V – 4.75 V		
CAT1022ZD4I-42T3*	4.25 V – 4.50 V		
CAT1022ZD4I-30T3*	3.00 V – 3.15 V		
CAT1022ZD4I-28T3*	2.85 V – 3.00 V		
CAT1022ZD4I-25T3*	2.55 V – 2.70 V		

†For information on tape and reel specifications, including part orientation and tape sizes, please refer to our Tape and Reel Packaging Specifications Brochure, BRD8011/D.

1. All packages are RoHS-compliant (Lead-free, Halogen-free).
2. The standard lead finish is NiPdAu.
3. For additional package and temperature options, please contact your nearest ON Semiconductor Sales office.
4. TDFN not available in NiPdAu (-G) version.
5. For detailed information and a breakdown of device nomenclature and numbering systems, please see the ON Semiconductor Device Nomenclature document, TND310/D, available at [www.onsemi.com](http://www.onsemi.com)

## CAT1021, CAT1022, CAT1023

<b>Orderable Part Numbers – CAT1023 Series</b> (See Notes 1 – 5)			
Device	Reset Threshold	Package	Shipping†
CAT1023WI-45-GT3	4.50 V – 4.75 V	SOIC	3000 Tape & Reel
CAT1023WI-42-GT3	4.25 V – 4.50 V		
CAT1023WI-30-GT3	3.00 V – 3.15 V		
CAT1023WI-28-GT3	2.85 V – 3.00 V		
CAT1023WI-25-GT3	2.55 V – 2.70 V		
CAT1023YI-45-GT3	4.50 V – 4.75 V	TSSOP	
CAT1023YI-42-GT3	4.25 V – 4.50 V		
CAT1023YI-30-GT3	3.00 V – 3.15 V		
CAT1023YI-28-GT3	2.85 V – 3.00 V		
CAT1023YI-25-GT3	2.55 V – 2.70 V		
CAT1023ZI-45-GT3	4.50 V – 4.75 V	MSOP	
CAT1023ZI-42-GT3	4.25 V – 4.50 V		
CAT1023ZI-30-GT3	3.00 V – 3.15 V		
CAT1023ZI-28-GT3	2.85 V – 3.00 V		
CAT1023ZI-25-GT3	2.55 V – 2.70 V		
CAT1023ZD4I-45T3*	4.50 V – 4.75 V	TDFN	
CAT1023ZD4I-42T3*	4.25 V – 4.50 V		
CAT1023ZD4I-30T3*	3.00 V – 3.15 V		
CAT1023ZD4I-28T3*	2.85 V – 3.00 V		
CAT1023ZD4I-25T3*	2.55 V – 2.70 V		

†For information on tape and reel specifications, including part orientation and tape sizes, please refer to our Tape and Reel Packaging Specifications Brochure, BRD8011/D.

1. All packages are RoHS-compliant (Lead-free, Halogen-free).
2. The standard lead finish is NiPdAu.
3. For additional package and temperature options, please contact your nearest ON Semiconductor Sales office.
4. TDFN not available in NiPdAu (-G) version.
5. For detailed information and a breakdown of device nomenclature and numbering systems, please see the ON Semiconductor Device Nomenclature document, TND310/D, available at [www.onsemi.com](http://www.onsemi.com)

**MECHANICAL CASE OUTLINE**  
**PACKAGE DIMENSIONS**

ON Semiconductor®



**SOIC 8, 150 mils**  
**CASE 751BD-01**  
**ISSUE O**

DATE 19 DEC 2008

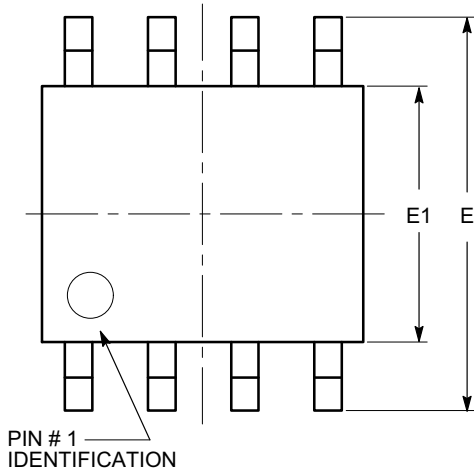

**TOP VIEW**

SYMBOL	MIN	NOM	MAX
A	1.35		1.75
A1	0.10		0.25
b	0.33		0.51
c	0.19		0.25
D	4.80		5.00
E	5.80		6.20
E1	3.80		4.00
e	1.27 BSC		
h	0.25		0.50
L	0.40		1.27
$\theta$	0°		8°

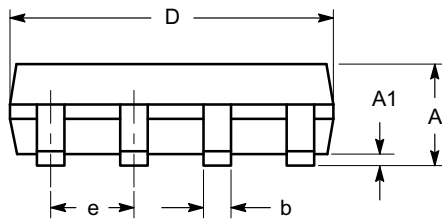

**SIDE VIEW**

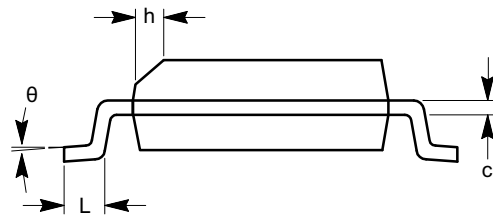

**END VIEW**

**Notes:**

- (1) All dimensions are in millimeters. Angles in degrees.
- (2) Complies with JEDEC MS-012.

<b>DOCUMENT NUMBER:</b>	<b>98AON34272E</b>	Electronic versions are uncontrolled except when accessed directly from the Document Repository. Printed versions are uncontrolled except when stamped "CONTROLLED COPY" in red.
<b>STATUS:</b>	<b>ON SEMICONDUCTOR STANDARD</b>	
<b>REFERENCE:</b>		
<b>DESCRIPTION:</b>	<b>SOIC 8, 150 MILS</b>	<b>PAGE 1 OF 2</b>



# MECHANICAL CASE OUTLINE

## PACKAGE DIMENSIONS

ON Semiconductor®



MSOP 8, 3x3  
CASE 846AD-01  
ISSUE O

DATE 19 DEC 2008

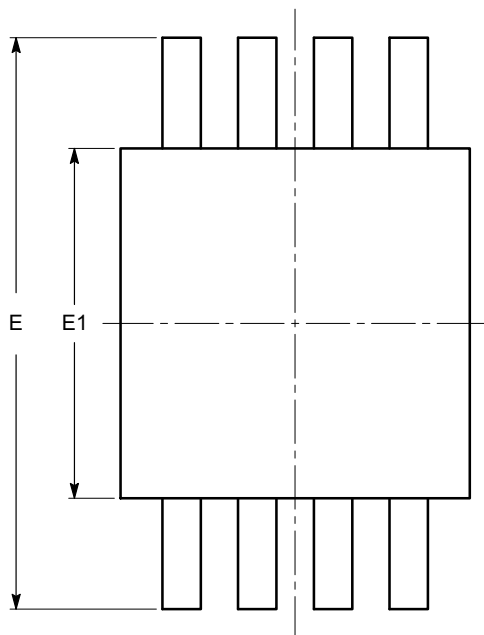

TOP VIEW

SYMBOL	MIN	NOM	MAX
A			1.10
A1	0.05	0.10	0.15
A2	0.75	0.85	0.95
b	0.22		0.38
c	0.13		0.23
D	2.90	3.00	3.10
E	4.80	4.90	5.00
E1	2.90	3.00	3.10
e	0.65 BSC		
L	0.40	0.60	0.80
L1	0.95 REF		
L2	0.25 BSC		
$\theta$	0°		6°

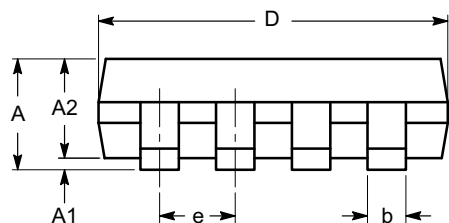

SIDE VIEW

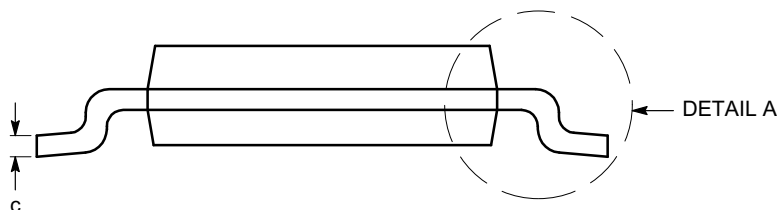

END VIEW

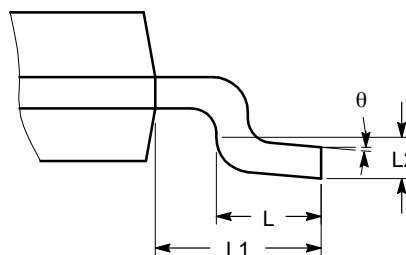

DETAIL A

**Notes:**

- (1) All dimensions are in millimeters. Angles in degrees.
- (2) Complies with JEDEC MO-187.

<b>DOCUMENT NUMBER:</b>	98AON34074E	Electronic versions are uncontrolled except when accessed directly from the Document Repository. Printed versions are uncontrolled except when stamped "CONTROLLED COPY" in red.
<b>STATUS:</b>	ON SEMICONDUCTOR STANDARD	
<b>REFERENCE:</b>		
<b>DESCRIPTION:</b>	MSOP 8, 3X3	<b>PAGE 1 OF 2</b>



**TDFN8, 3x3**  
CASE 511AL-01  
ISSUE A

DATE 24 MAR 2009

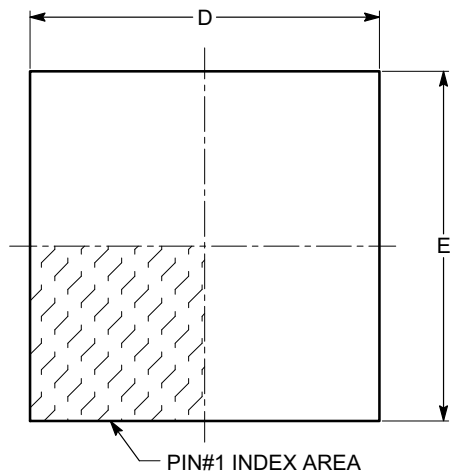

**TOP VIEW**

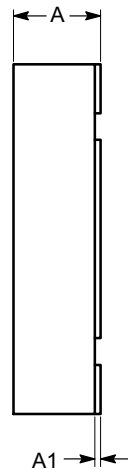

**SIDE VIEW**

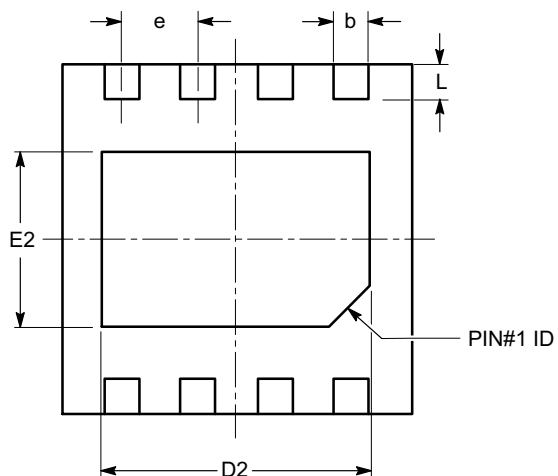

**BOTTOM VIEW**

SYMBOL	MIN	NOM	MAX
A	0.70	0.75	0.80
A1	0.00	0.02	0.05
A3	0.20 REF		
b	0.23	0.30	0.37
D	2.90	3.00	3.10
D2	2.20	---	2.50
E	2.90	3.00	3.10
E2	1.40	---	1.80
e	0.65 TYP		
L	0.20	0.30	0.40

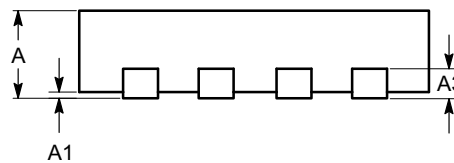

**FRONT VIEW**

**Notes:**

- (1) All dimensions are in millimeters.
- (2) Complies with JEDEC MO-229.

<b>DOCUMENT NUMBER:</b>	<b>98AON34340E</b>	Electronic versions are uncontrolled except when accessed directly from the Document Repository. Printed versions are uncontrolled except when stamped "CONTROLLED COPY" in red.
<b>STATUS:</b>	<b>ON SEMICONDUCTOR STANDARD</b>	
<b>REFERENCE:</b>		
<b>DESCRIPTION:</b>	<b>TDFN8, 3X3</b>	<b>PAGE 1 OF 2</b>



# MECHANICAL CASE OUTLINE PACKAGE DIMENSIONS

ON Semiconductor®

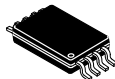

SCALE 2:1

## TSSOP-8 CASE 948S-01 ISSUE C

DATE 20 JUN 2008

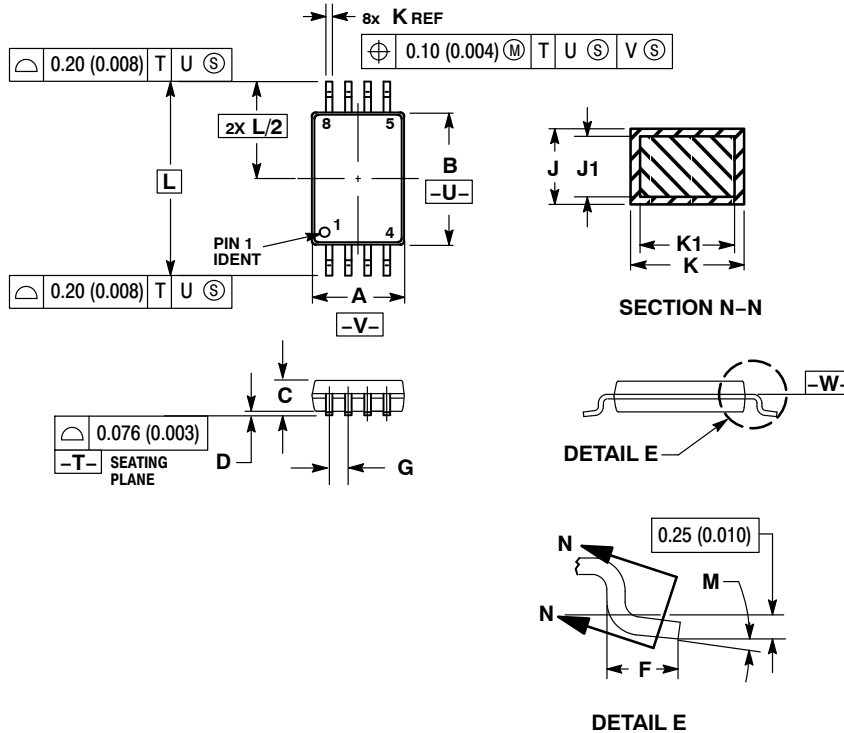

NOTES:

1. DIMENSIONING AND TOLERANCING PER ANSI Y14.5M, 1982.
2. CONTROLLING DIMENSION: MILLIMETER.
3. DIMENSION A DOES NOT INCLUDE MOLD FLASH, PROTRUSIONS OR GATE BURRS. MOLD FLASH OR GATE BURRS SHALL NOT EXCEED 0.15 (0.006) PER SIDE.
4. DIMENSION B DOES NOT INCLUDE INTERLEAD FLASH OR PROTRUSION. INTERLEAD FLASH OR PROTRUSION SHALL NOT EXCEED 0.25 (0.010) PER SIDE.
5. TERMINAL NUMBERS ARE SHOWN FOR REFERENCE ONLY.
6. DIMENSION A AND B ARE TO BE DETERMINED AT DATUM PLANE -W-.

DIM	MILLIMETERS		INCHES	
	MIN	MAX	MIN	MAX
A	2.90	3.10	0.114	0.122
B	4.30	4.50	0.169	0.177
C	---	1.10	---	0.043
D	0.05	0.15	0.002	0.006
F	0.50	0.70	0.020	0.028
G	0.65 BSC		0.026 BSC	
J	0.09	0.20	0.004	0.008
J1	0.09	0.16	0.004	0.006
K	0.19	0.30	0.007	0.012
K1	0.19	0.25	0.007	0.010
L	6.40 BSC		0.252 BSC	
M	0°	8°	0°	8°

### GENERIC MARKING DIAGRAM\*

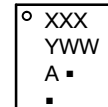

- XXX = Specific Device Code
- A = Assembly Location
- Y = Year
- WW = Work Week
- = Pb-Free Package

\*This information is generic. Please refer to device data sheet for actual part marking. Pb-Free indicator, "G" or microdot "■", may or may not be present.

DOCUMENT NUMBER:	98AON00697D	Electronic versions are uncontrolled except when accessed directly from the Document Repository. Printed versions are uncontrolled except when stamped "CONTROLLED COPY" in red.
STATUS:	ON SEMICONDUCTOR STANDARD	
NEW STANDARD:		
DESCRIPTION:	TSSOP-8	PAGE 1 OF 2



ON Semiconductor and  are trademarks of Semiconductor Components Industries, LLC dba ON Semiconductor or its subsidiaries in the United States and/or other countries. ON Semiconductor owns the rights to a number of patents, trademarks, copyrights, trade secrets, and other intellectual property. A listing of ON Semiconductor's product/patent coverage may be accessed at [www.onsemi.com/site/pdf/Patent-Marking.pdf](http://www.onsemi.com/site/pdf/Patent-Marking.pdf). ON Semiconductor reserves the right to make changes without further notice to any products herein. ON Semiconductor makes no warranty, representation or guarantee regarding the suitability of its products for any particular purpose, nor does ON Semiconductor assume any liability arising out of the application or use of any product or circuit, and specifically disclaims any and all liability, including without limitation special, consequential or incidental damages. Buyer is responsible for its products and applications using ON Semiconductor products, including compliance with all laws, regulations and safety requirements or standards, regardless of any support or applications information provided by ON Semiconductor. "Typical" parameters which may be provided in ON Semiconductor data sheets and/or specifications can and do vary in different applications and actual performance may vary over time. All operating parameters, including "Typicals" must be validated for each customer application by customer's technical experts. ON Semiconductor does not convey any license under its patent rights nor the rights of others. ON Semiconductor products are not designed, intended, or authorized for use as a critical component in life support systems or any FDA Class 3 medical devices or medical devices with a same or similar classification in a foreign jurisdiction or any devices intended for implantation in the human body. Should Buyer purchase or use ON Semiconductor products for any such unintended or unauthorized application, Buyer shall indemnify and hold ON Semiconductor and its officers, employees, subsidiaries, affiliates, and distributors harmless against all claims, costs, damages, and expenses, and reasonable attorney fees arising out of, directly or indirectly, any claim of personal injury or death associated with such unintended or unauthorized use, even if such claim alleges that ON Semiconductor was negligent regarding the design or manufacture of the part. ON Semiconductor is an Equal Opportunity/Affirmative Action Employer. This literature is subject to all applicable copyright laws and is not for resale in any manner.

## PUBLICATION ORDERING INFORMATION

### LITERATURE FULFILLMENT:

Literature Distribution Center for ON Semiconductor  
19521 E. 32nd Pkwy, Aurora, Colorado 80011 USA  
**Phone:** 303-675-2175 or 800-344-3860 Toll Free USA/Canada  
**Fax:** 303-675-2176 or 800-344-3867 Toll Free USA/Canada  
**Email:** [orderlit@onsemi.com](mailto:orderlit@onsemi.com)

**N. American Technical Support:** 800-282-9855 Toll Free  
USA/Canada  
**Europe, Middle East and Africa Technical Support:**  
Phone: 421 33 790 2910

**ON Semiconductor Website:** [www.onsemi.com](http://www.onsemi.com)

**Order Literature:** <http://www.onsemi.com/orderlit>

For additional information, please contact your local  
Sales Representative

## Looking for pricing, stock, or lifecycle information?

Click below to explore more details on WIN SOURCE:

 [View CAT1023WI-42](#) on WIN SOURCE

 [ON Semiconductor](#) Information

## Optimize Your Supply Chain with WIN SOURCE Solutions

-  Global Sourcing Solution
-  Obsolete Management
-  Cost Control Management
-  Shortage Management
-  Alternative Solution
-  Excess Inventory Management