



**THE DATASHEET OF  
S2SD-17-24-L-78.75-SR**



**DESIGNED & DIMENSIONED  
IN MILLIMETERS[INCHES]**

**S2SDX-XX-XXX-XX-XX.XX-XX-XXX**

DO NOT  
SCALE FROM  
THIS PRINT

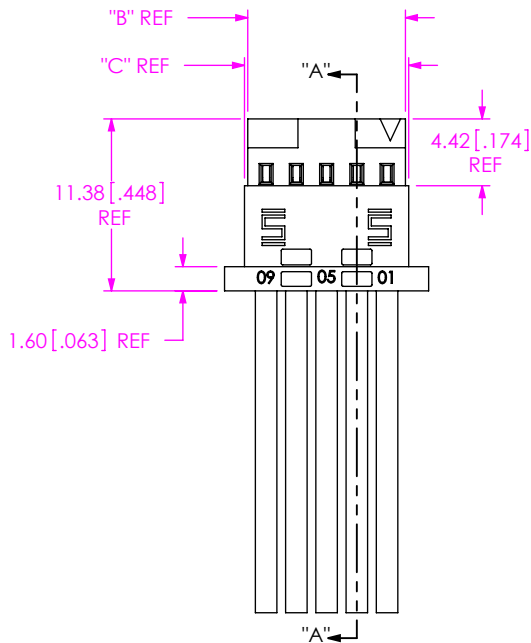
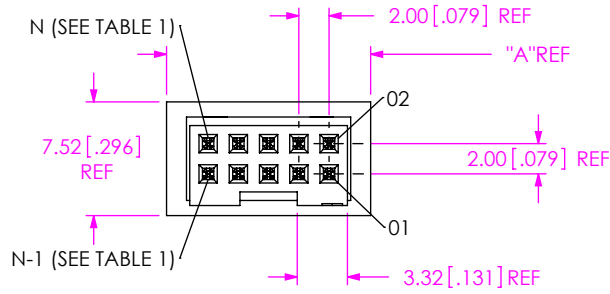

**TEFLON CABLE OPTION**  
-T: TEFLON (AVAILABLE WITH  
24, 28 & 30AWG ONLY)  
(LEAVE BLANK FOR STANDARD  
PVC INSULATION)

**No OF POSITIONS**  
-02, -04, -05, -07, -10, -15, -20,  
-25, & -30 (PER ROW)  
AVAILABLE AS STANDARD  
-05 THRU -50 AVAILABLE AS ASO

**WIRE GAUGE (AWG)**  
-24, -26, -28, & 30

**COLOR CODE**  
(LEAVE BLANK FOR ALL BLACK WIRE)  
-C: COLOR CODED WIRE, SEE TABLE 3,  
SHEET 3 FOR COLOR SEQUENCE  
(AVAILABLE WITH 24 AWG ONLY)  
(NOT AVAILABLE FOR TEFLON OPTION,  
TEFLON CABLE ONLY AVAILABLE IN BLUE)

**PLATING SPECIFICATION**  
-L: LIGHT SELECTIVE  
-S: SELECTIVE

**-NXX OPTION (END 2)**  
(ONLY AVAILABLE WITH -D, -DL, -DR, -DS)  
-NUS: NOTCH UP, STRAIGHT  
(PIN 1 TO N-1) (SEE FIG 2)  
-NDS: NOTCH DOWN, STRAIGHT  
(PIN 1 TO 2) (SEE FIG 4)  
-NUX: NOTCH UP, CROSSED  
(PIN 1 TO N) (SEE FIG 3)  
-NDX: NOTCH DOWN, CROSSED  
(PIN 1 TO 1) (SEE FIG 5)

**END OPTION**  
-S: SINGLE ENDED (SEE FIG 1)  
-D: DOUBLE ENDED (SEE FIG'S 2, 3, 4, 5, 6, & 7)  
-SR: SINGLE ENDED WITH RETENTION LATCH  
(SEE FIG 6)  
-DR: DOUBLE ENDED WITH RETENTION LATCH  
(SEE FIG 7)  
-SS: DUAL SCREW DOWN, SINGLE ENDED CABLE  
(SEE FIG 8, SHT 3) (ONLY AVAILABLE UP TO  
30 POSITIONS) (USES ISD2-XX-D-S,  
CPS-RR-M2-01-N, AND ACCRT-01)  
-DS: DUAL SCREW DOWN, DOUBLE ENDED CABLE  
(SEE FIG 9, SHT 3) (ONLY AVAILABLE UP TO  
30 POSITIONS) (USES ISD2-XX-D-S,  
CPS-RR-M2-01-N, AND ACCRT-01)

**ASSEMBLED LENGTH**  
SPECIFY IN INCHES  
SINGLE ENDED: 02.75 INCH MINIMUM  
DOUBLE ENDED: 02.75 INCH MINIMUM

\*\* = NOT RELEASED FOR PRODUCTION

No OF POSITIONS	N	N-1	"A"	"B"	"C"
-02	4	3	7.500	4.430	4.860
-04	8	7	11.500	8.430	8.860
-05	10	9	13.500	10.430	10.860
-07	14	13	17.500	14.430	14.860
-10	20	19	23.500	20.430	20.860
-15	30	29	33.500	30.430	30.860
-20	40	39	43.500	40.430	40.860
-25	50	49	53.500	50.430	50.860
-30	60	59	63.500	60.43	60.860

SERIES	AWG	CABLE	CONTACT
S2SD	24	DWC-24-XX-300	C-281-2426-X
S2SD	26	DWC-26-XX-300	C-281-2426-X
S2SD	28	DWC-28-XX-300	C-281-2830-X
S2SD	30	DWC-30-XX-300	C-281-2830-X
*S2SDT	24	DWCT-24-01-TC	C-281-2426-X
*S2SDT	28	DWCT-28-01-TC	C-281-2830-X
*S2SDT	30	DWCT-30-01-TC	C-281-2830-X

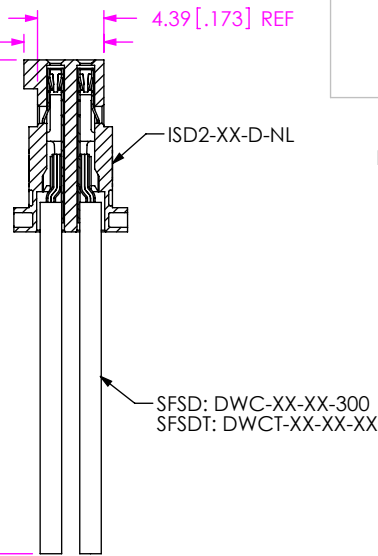

ASSEMBLED LENGTH  
(SEE NOTE 8)

**SECTION "A"- "A"**

**FIG 1**  
S2SDX-05-24-X-XX.XX-S SHOWN

**NOTES:**

1. REPRESENTS A CRITICAL DIMENSION.
2. MINIMUM PULLOUT FORCE: 11.1N [2.5LBS].
3. CONTACTS MUST BE INSERTED UNTIL RETENTION FEATURES LOCK INTO PLACE.
4. ALL FINISHED GOODS ARE TO BE ELECTRICALLY TESTED INCLUDING HI-POT TEST AT 1000 VOLTS DC. AFTER FINAL ELECTRICAL TEST, MARK EACH ASSEMBLY PER INSTRUCTIONS REFERENCED IN CO-{AD-ID}-WI-3092-M.
5. TINNED COPPER WIRE IS RoHS COMPLIANT.
6. PARTS TO BE LAYER PACKAGED.
7. END OF DISCRETE WIRE MUST FALL WITHIN THIS RANGE AFTER CRIMP.
8. FOR LENGTHS OF 12.00 INCHES AND LESS, TOLERANCE TO BE ± 3.18[.125], FOR LENGTHS GREATER THAN 12.00 INCHES, TOLERANCE TO BE ± 2%
9. REFER TO CRIMP SPECIFICATIONS PRINT FOR CRIMP AND STRIP DIMENSIONS, TOLERANCES, TOOLING AND ITS REQUIREMENTS.
10. NOTE DELETED
11. -TC TEFLON IS TO BE USED EXCLUSIVE WITH DOUBLE ENDED ASSEMBLIES, ALL SINGLE ENDED ASSEMBLIES USE SILVER PLATED DWCT-XX-01.
12. CUT LENGTH IS ASSEMBLY LENGTH MINUS OVERALL LENGTH SUBTRACTOR.
13. DUAL POLARIZATION FEATURE NOT AVAILABLE ON BODIES LESS THAN 5 POSITIONS.
14. THE PRODUCTS WITH OPTION -DS AND -SS SHOULD BE PACKAGED IN BUBBLE BAGS.

UNLESS OTHERWISE SPECIFIED,  
DIMENSIONS ARE IN MILLIMETERS.  
TOLERANCES ARE:  
DECIMALS ANGLES  
X.X: ±0.3 [.01] 2°  
X.XX: ±0.13 [.005]  
X.XXX: ±0.051 [.0020]

**PROPRIETARY NOTE**  
THIS DOCUMENT CONTAINS CONFIDENTIAL AND PROPRIETARY INFORMATION AND ALL DESIGN, MANUFACTURING, REPRODUCTION, USE, PATENT RIGHTS AND SALES RIGHTS ARE EXPRESSLY RESERVED BY SAMTEC, INC. THIS DOCUMENT SHALL NOT BE DISCLOSED, IN WHOLE OR PART, TO ANY UNAUTHORIZED PERSON OR ENTITY NOR REPRODUCED, TRANSFERRED OR INCORPORATED IN ANY OTHER PROJECT IN ANY MANNER WITHOUT THE EXPRESS WRITTEN CONSENT OF SAMTEC, INC.

**MATERIAL:** DO NOT SCALE DRAWING SHEET SCALE: 2:1  
INSULATOR: LCP, COLOR: BLACK  
CONTACT: B8CU  
CABLE INSULATION  
S2SD: PVC, COLOR: (SEE 'COLOR CODE')  
S2SDT: TEFLON, COLOR: BLUE  
CABLE WIRE  
S2SD: TINNED COPPER  
S2SDT: SILVERED COPPER or TINNED COPPER (SEE DWCT PRINT FOR OPTIONS)  
F:\DWG\MISC\MKTG\S2SDX-XX-XXX-XX-XX.XX-XXX-MKT.SLDRW

**samtec**  
520 PARK EAST BLVD, NEW ALBANY, IN 47150  
PHONE: 812-944-6733 FAX: 812-948-5047  
e-Mail: info@SAMTEC.com code 55322

DESCRIPTION:  
**2.00mm SOCKET DISCRETE CABLE ASSEMBLY**  
DWG. NO.  
**S2SDX-XX-XXX-XX-XX.XX-XX-XXX**  
BY: J. BORGELT 2/20/09 SHEET 1 OF 4

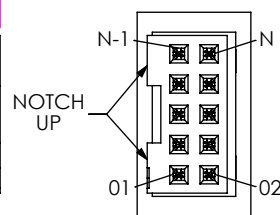
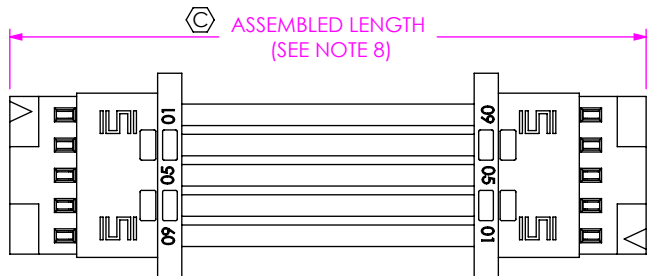
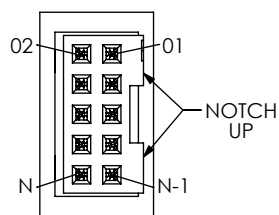

**FIG 2**  
(S2SDX-05-28-X-XX.XX-D-NUS SHOWN)  
(SAME AS FIG 1, EXCEPT AS SHOWN)  
(PIN 01 TO N-1)

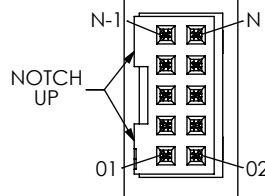
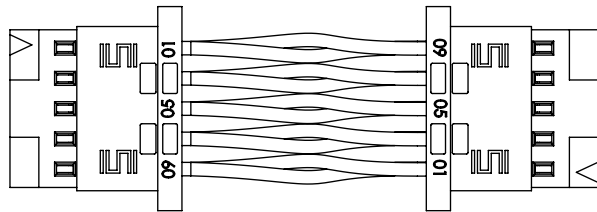
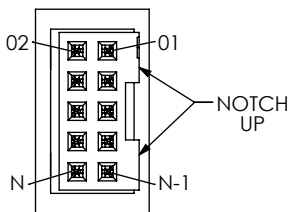

**FIG 3**  
(S2SDX-05-28-X-XX.XX-D-NUX SHOWN)  
(SAME AS FIG 1, EXCEPT AS SHOWN)  
(PIN 01 TO N)

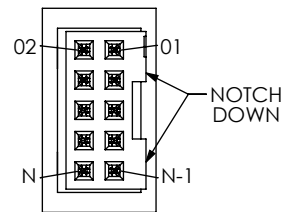
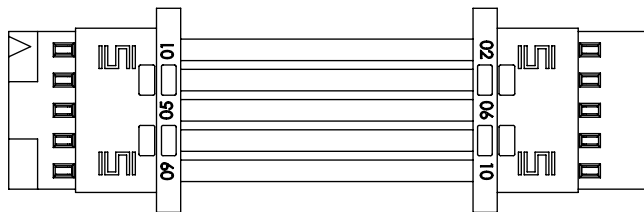
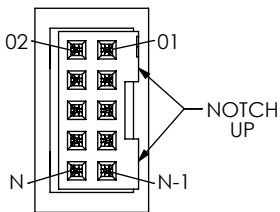

**FIG 4**  
(S2SDX-05-28-X-XX.XX-D-NDS SHOWN)  
(SAME AS FIG 1, EXCEPT AS SHOWN)  
(PIN 01 TO 02)

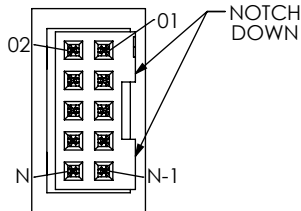
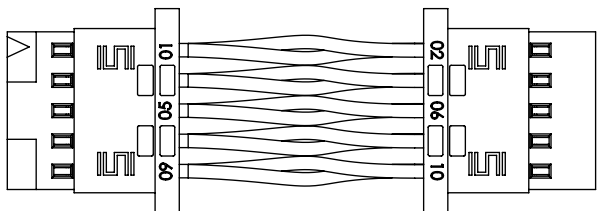
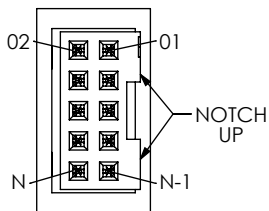

**FIG 5**  
(S2SDX-05-28-X-XX.XX-D-NDX SHOWN)  
(SAME AS FIG 1, EXCEPT AS SHOWN)  
(PIN 01 TO 01)

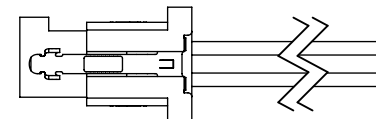
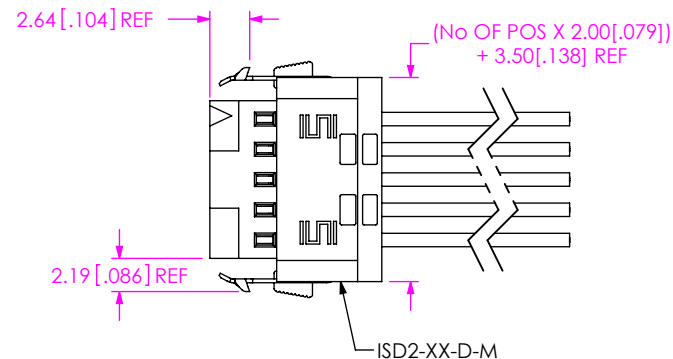

**FIG 6**  
(S2SDX-05-28-X-XX.XX-SR SHOWN)  
(SAME AS FIG 1, EXCEPT AS SHOWN)

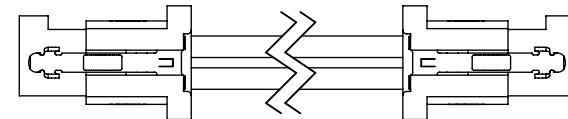
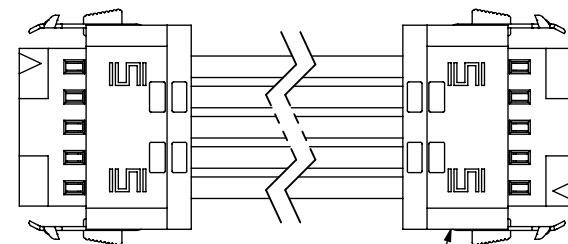

**FIG 7**  
(S2SDX-05-28-X-XX.XX-DR-NUS SHOWN)  
(SAME AS FIG 6, EXCEPT AS SHOWN)

F:\DWG\MISC\MKTG\S2SDX-XX-XXX-XX-XX-XX-XXX-MKT.SLDDRW

**PROPRIETARY NOTE**  
THIS DOCUMENT CONTAINS CONFIDENTIAL AND PROPRIETARY INFORMATION AND ALL DESIGN, MANUFACTURING, REPRODUCTION, USE, PATENT RIGHTS AND SALES RIGHTS ARE EXPRESSLY RESERVED BY SAMTEC, INC. THIS DOCUMENT SHALL NOT BE DISCLOSED, IN WHOLE OR PART, TO ANY UNAUTHORIZED PERSON OR ENTITY NOR REPRODUCED, TRANSFERRED OR INCORPORATED IN ANY OTHER PROJECT IN ANY MANNER WITHOUT THE EXPRESS WRITTEN CONSENT OF SAMTEC, INC.

DO NOT SCALE DRAWING

SHEET SCALE: 2:1



520 PARK EAST BLVD. NEW ALBANY, IN 47150  
PHONE: 812-944-6733 FAX: 812-948-5047  
e-Mail info@SAMTEC.com code 55322

DESCRIPTION:  
2.00mm SOCKET DISCRETE CABLE ASSEMBLY

DWG. NO.  
**S2SDX-XX-XXX-XX-XX-XX-XXX**

BY: J. BORGELT 2/20/09 SHEET 2 OF 4

ASSEMBLED LENGTH  
(SEE NOTE 8 & 12)

CUT LINE

(ASSEMBLED LENGTH X 2)  
+ 12.70[.500] ADDER  
(SEE NOTE 8 & 12)

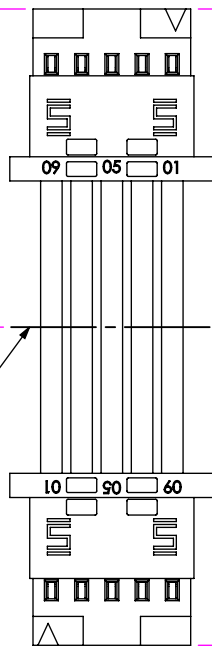

**IN-PROCESS 1**  
(APPLIES TO -S, & -SR END OPTIONS ONLY)  
(TO BE BUILT DOUBLE-ENDED INITIALLY  
FOR E-TEST AND THEN SEPERATED)

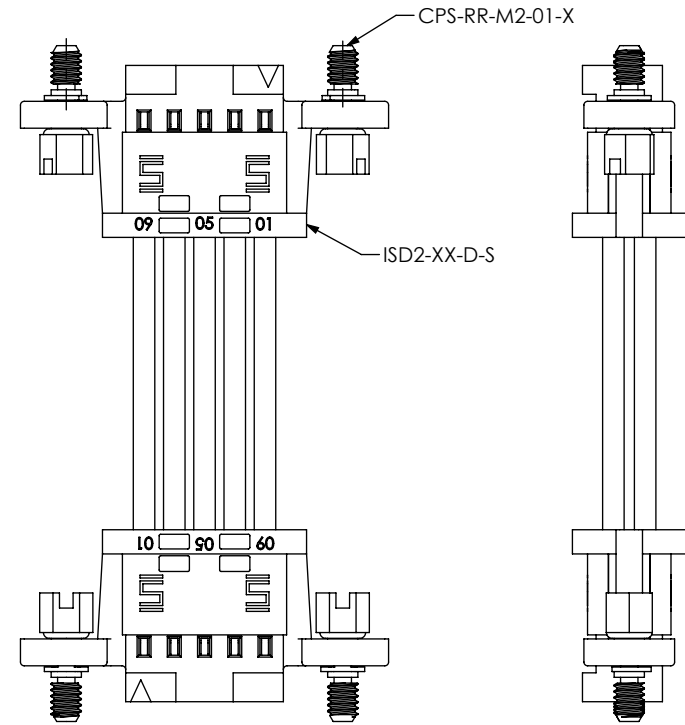

**FIG 9**  
-DS: DOUBLE ENDED WITH SCREW DOWN  
(S2SDX-05-28-X-XX.XX-DS-NUS SHOWN)  
(SAME AS FIG 8, EXCEPT AS SHOWN)

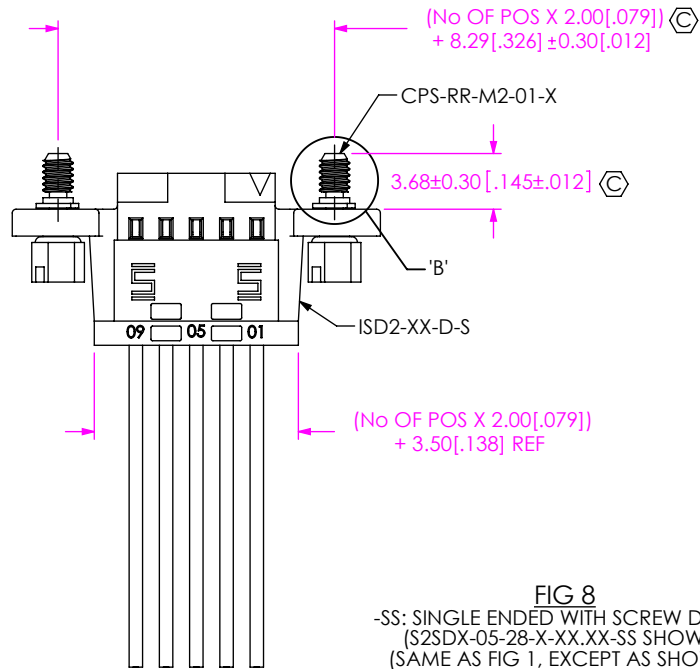

**FIG 8**  
-SS: SINGLE ENDED WITH SCREW DOWN  
(S2SDX-05-28-X-XX.XX-SS SHOWN)  
(SAME AS FIG 1, EXCEPT AS SHOWN)

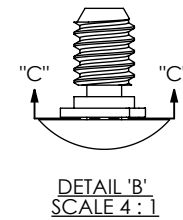
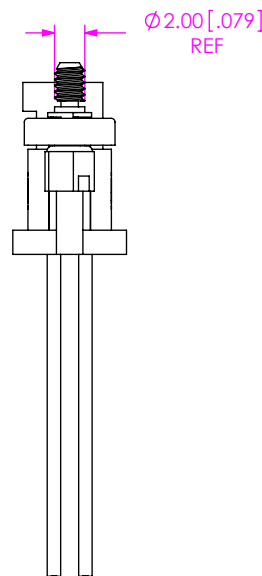

**DETAIL 'B'**  
SCALE 4 : 1

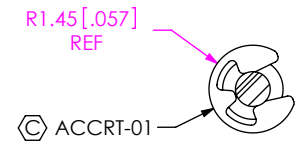

**SECTION "C"-"C"**  
SCALE 4 : 1

F:\DWG\MISC\MKTG\S2SDX-XX-XXX-XX-XX.XX-XXX-MKT.SLDRW

**PROPRIETARY NOTE**  
THIS DOCUMENT CONTAINS CONFIDENTIAL AND PROPRIETARY INFORMATION AND ALL DESIGN, MANUFACTURING, REPRODUCTION, USE, PATENT RIGHTS AND SALES RIGHTS ARE EXPRESSLY RESERVED BY SAMTEC, INC. THIS DOCUMENT SHALL NOT BE DISCLOSED, IN WHOLE OR PART, TO ANY UNAUTHORIZED PERSON OR ENTITY NOR REPRODUCED, TRANSFERRED OR INCORPORATED IN ANY OTHER PROJECT IN ANY MANNER WITHOUT THE EXPRESS WRITTEN CONSENT OF SAMTEC, INC.

DO NOT SCALE DRAWING  
SHEET SCALE: 2:1



520 PARK EAST BLVD, NEW ALBANY, IN 47150  
PHONE: 812-944-6733 FAX: 812-948-5047  
e-Mail info@SAMTEC.com code 55322

DESCRIPTION:  
2.00mm SOCKET DISCRETE CABLE ASSEMBLY

DWG. NO.  
**S2SDX-XX-XXX-XX-XX.XX-XX-XXX**

BY: J. BORGELT 2/20/09 SHEET 3 OF 4

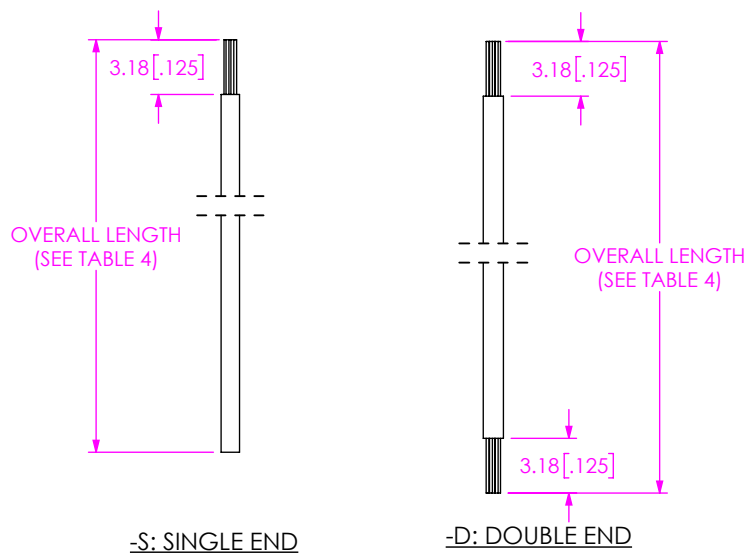

CABLE CUT IN-PROCESS

TABLE 4 ( OVERALL LENGTH SUBTRACTORS) (SEE NOTE 12)	
	LENGTH
-S: SINGLE END	.224 [5.69]
-D: DOUBLE END	.448 [11.38]

TABLE 3										
POS #	COLOR SEQUENCE									
	BROWN	RED	ORANGE	YELLOW	GREEN	VIOLET	GRAY	WHITE	BLACK	BLUE
	1	2	3	4	5	6	7	8	9	10
	11	12	13	14	15	16	17	18	19	20
	21	22	23	24	25	26	27	28	29	30
	31	32	33	34	35	36	37	38	39	40
	41	42	43	44	45	46	47	48	49	50
	51	52	53	54	55	56	57	58	59	60
	61	62	63	64	65	66	67	68	69	70
	71	72	73	74	75	76	77	78	79	80
	81	82	83	84	85	86	87	88	89	90
	91	92	93	94	95	96	97	98	99	100

F:\DWG\MISC\MKTG\S2SDX-XX-XXX-XX-XX-XX-XXX-MKT.SLDDRW

<p style="text-align: center;">* PROPRIETARY NOTE *</p> <p style="font-size: small;">THIS DOCUMENT CONTAINS CONFIDENTIAL AND PROPRIETARY INFORMATION AND ALL DESIGN, MANUFACTURING, REPRODUCTION, USE, PATENT RIGHTS AND SALES RIGHTS ARE EXPRESSLY RESERVED BY SAMTEC, INC. THIS DOCUMENT SHALL NOT BE DISCLOSED, IN WHOLE OR PART, TO ANY UNAUTHORIZED PERSON OR ENTITY NOR REPRODUCED, TRANSFERRED OR INCORPORATED IN ANY OTHER PROJECT IN ANY MANNER WITHOUT THE EXPRESS WRITTEN CONSENT OF SAMTEC, INC.</p> <p style="text-align: center;">DO NOT SCALE DRAWING</p> <p style="text-align: center;">SHEET SCALE: 2:1</p>	 <p style="font-size: x-small;">520 PARK EAST BLVD, NEW ALBANY, IN 47150 PHONE: 812-944-6733 FAX: 812-948-5047 e-Mail info@SAMTEC.com code 55322</p>
	<p>DESCRIPTION: <b>2.00mm SOCKET DISCRETE CABLE ASSEMBLY</b></p>
	<p>DWG. NO. <b>S2SDX-XX-XXX-XX-XX-XX-XXX</b></p>
	<p>BY: J. BORGELT 2/20/09      SHEET 4 OF 4</p>

## Looking for pricing, stock, or lifecycle information?

Click below to explore more details on WIN SOURCE:

 [View S2SD-17-24-L-78.75-SR on WIN SOURCE](#)

 [Samtec Inc. Information](#)

## Optimize Your Supply Chain with WIN SOURCE Solutions

-  Global Sourcing Solution
-  Obsolete Management
-  Cost Control Management
-  Shortage Management
-  Alternative Solution
-  Excess Inventory Management