



**THE DATASHEET OF
SZ1SMA85AT3G**



SZ1SMA Series



Description

The SZ1SMA series is designed to protect voltage sensitive components from high voltage, high energy transients. They have excellent clamping capability, high surge capability, low zener impedance and fast response time. The SZ1SMA series is supplied in the Littelfuse exclusive, cost-effective, highly reliable package and is ideally suited for use in communication systems, automotive, numerical controls, process controls, medical equipment, business machines, power supplies and many other industrial and consumer applications.

Agency Approvals

| Agency | Agency File Number |
|---|--------------------|
|  | E128662 |

Maximum Ratings and Thermal Characteristics

| Parameter | Symbol | Value | Unit |
|---|--------------------|-------------|----------------------------|
| Peak Power Dissipation (Note 1) @ $T_L = 25^\circ\text{C}$, Pulse Width = 1 ms | P_{PK} | 400 | W |
| DC Power Dissipation @ $T_L = 75^\circ\text{C}$ Measured Zero Lead Length (Note 2) Derate Above 75°C Thermal Resistance from Junction-to-Lead | P_D | 1.5 | W |
| | $R_{\theta JL}$ | 20 | $\text{mW}/^\circ\text{C}$ |
| DC Power Dissipation (Note 3) @ $T_A = 25^\circ\text{C}$ Derate Above 25°C Thermal Resistance from Junction-to-Ambient | P_D | 0.5 | W |
| | $R_{\theta JA}$ | 4.0 | $\text{mW}/^\circ\text{C}$ |
| Forward Surge Current (Note 4) @ $T_A = 25^\circ\text{C}$ (for uni-directional) | I_{FSM} | 40 | A |
| Operating and Storage Temperature Range | T_J T_{stg} | -65 to +150 | $^\circ\text{C}$ |

Stresses exceeding those listed in the Maximum Ratings table may damage the device. If any of these limits are exceeded, device functionality should not be assumed, damage may occur and reliability may be affected.

- 10 X 1000 μs , non-repetitive.
- 1" square copper pad, FR-4 board.
- FR-4 board, using Littelfuse minimum recommended footprint
- 1/2 sine wave (or equivalent square wave), PW = 8.3 ms, duty cycle = 4 pulses per minute maximum. (for uni-directional)

Features

- Zener Transient Overvoltage Suppressors
- Working Peak Reverse Voltage Range -5V to 170V for uni-directional and 10 V to 78 V for bi-directional
- Standard Zener Breakdown Voltage Range -11.1 V to 95.83 V for bi-directional, 6.4 V to 209 V for uni-directional
- Peak Power – 400 W @ 1 ms
- ESD Rating of Class 3 (> 16 kV) per Human Body Model
- Response Time is Typically < 1 ns
- Flat Handling Surface for Accurate Placement
- Package Design for Top Slide or Bottom Circuit Board Mounting
- Low Profile Package
- Pb-free means 2nd level interconnect is Pb-free and the terminal finish material is tin(Sn) (IPC/JEDEC J-STD-609A.01)
- SZ Prefix for Automotive and Other Applications Requiring Unique Site and Control Change Requirements; AEC-Q101 Qualified and PPAP Capable
- Recognized to UL 497B as an Isolated Loop Circuit Protector
- RoHS-compliant and halogen-free

Additional Information



[Datasheet](#)



[Resources](#)



[Samples](#)

Functional Diagram

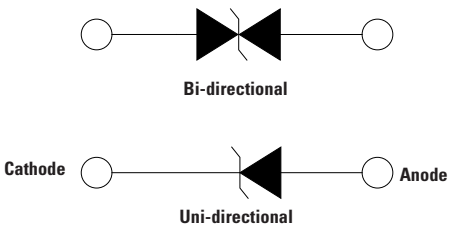

I-V Curve Characteristics ($T_A = 25^\circ\text{C}$ unless otherwise noted) – For Bi-directional



| Symbol | Parameter |
|-----------|---|
| I_{PP} | Maximum Reverse Peak Pulse Current |
| V_C | Clamping Voltage @ I_{PP} |
| V_{RWM} | Working Peak Reverse Voltage |
| I_R | Maximum Reverse Leakage Current @ V_{RWM} |
| V_{BR} | Breakdown Voltage @ I_T |
| I_T | Test Current |

I-V Curve Characteristics ($T_A = 25^\circ\text{C}$ unless otherwise noted, $V_F = 3.5\text{ V Max.}$ @ $I_F = 30\text{ A}$ for all types) (Note 5) – For Uni-directional



| Symbol | Parameter |
|-----------|---|
| I_{PP} | Maximum Reverse Peak Pulse Current |
| V_C | Clamping Voltage @ I_{PP} |
| V_{RWM} | Working Peak Reverse Voltage |
| I_R | Maximum Reverse Leakage Current @ V_{RWM} |
| V_{BR} | Breakdown Voltage @ I_T |
| I_T | Test Current |
| I_F | Forward Current |
| V_F | Forward Voltage @ I_F |

5. 1/2 sine wave or equivalent, PW = 8.3 ms, non-repetitive duty cycle.

Electrical Characteristics – For Uni-directional

| Device | Device Marking | V _{RWM} ^{Note 6} | I _R @ V _{RWM} | Breakdown Voltage | | | | V _C @ I _{PP} ^{Note 8} | | C Typ. ^{Note 9} | Agency Approval  |
|---------------|----------------|------------------------------------|-----------------------------------|--|-------|-------|------------------|--|-----------------|--------------------------|---|
| | | | | V _{BR} @ I _T (V) ^{Note 7} | | | @ I _T | V _C | I _{PP} | | |
| | | | | MIN | NOM | MAX | mA | Volts | Amps | | |
| SZ1SMA5.0AT3G | QE | 5.0 | 400 | 6.40 | 6.70 | 7.00 | 10 | 9.2 | 43.5 | 2035 | X |
| SZ1SMA6.0AT3G | QG | 6.0 | 400 | 6.67 | 7.02 | 7.37 | 10 | 10.3 | 38.8 | 1730 | X |
| SZ1SMA6.5AT3G | QK | 6.5 | 250 | 7.22 | 7.60 | 7.98 | 10 | 11.2 | 35.7 | 1605 | X |
| SZ1SMA8.0AT3G | QR | 8.0 | 25 | 8.89 | 9.36 | 9.83 | 1 | 13.6 | 29.4 | 1035 | X |
| SZ1SMA8.5AT3G | QT | 8.5 | 5.0 | 9.44 | 9.92 | 10.40 | 1 | 14.4 | 27.8 | 1265 | X |
| SZ1SMA9.0AT3G | QV | 9.0 | 2.5 | 10.00 | 10.55 | 11.10 | 1 | 15.4 | 26.0 | 1200 | X |
| SZ1SMA10AT3G | QX | 10 | 2.5 | 11.10 | 11.70 | 12.30 | 1 | 17.0 | 23.5 | 1090 | X |
| SZ1SMA11AT3G | QZ | 11 | 2.5 | 12.20 | 12.85 | 13.50 | 1 | 18.2 | 22.0 | 1000 | X |
| SZ1SMA12AT3G | RE | 12 | 2.5 | 13.30 | 14.00 | 14.70 | 1 | 19.9 | 20.1 | 925 | X |
| SZ1SMA13AT3G | RG | 13 | 2.5 | 14.40 | 15.15 | 15.90 | 1 | 21.5 | 18.6 | 860 | X |
| SZ1SMA14AT3G | RH | 14 | 2.5 | 15.60 | 16.40 | 17.20 | 1 | 23.2 | 17.2 | 800 | X |
| SZ1SMA15AT3G | RM | 15 | 2.5 | 16.70 | 17.60 | 18.50 | 1 | 24.4 | 16.4 | 758 | X |
| SZ1SMA16AT3G | RP | 16 | 2.5 | 17.80 | 18.75 | 19.70 | 1 | 26.0 | 15.4 | 715 | X |
| SZ1SMA17AT3G | RR | 17 | 2.5 | 18.90 | 19.90 | 20.90 | 1 | 27.6 | 14.5 | 680 | X |
| SZ1SMA18AT3G | RT | 18 | 2.5 | 20.00 | 21.05 | 22.10 | 1 | 29.2 | 13.7 | 645 | X |
| SZ1SMA20AT3G | RV | 20 | 2.5 | 22.20 | 23.35 | 24.50 | 1 | 32.4 | 12.3 | 585 | X |
| SZ1SMA22AT3G | RX | 22 | 2.5 | 24.40 | 25.65 | 26.90 | 1 | 35.5 | 11.3 | 540 | X |
| SZ1SMA24AT3G | RZ | 24 | 2.5 | 26.70 | 28.10 | 29.50 | 1 | 38.9 | 10.3 | 500 | X |
| SZ1SMA26AT3G | SE | 26 | 2.5 | 28.90 | 30.40 | 31.90 | 1 | 42.1 | 9.5 | 460 | X |
| SZ1SMA28AT3G | SG | 28 | 2.5 | 31.10 | 32.75 | 34.40 | 1 | 45.4 | 8.8 | 430 | X |
| SZ1SMA30AT3G | SK | 30 | 1.0 | 33.30 | 35.05 | 36.80 | 1 | 48.4 | 8.3 | 405 | X |
| SZ1SMA33AT3G | SM | 33 | 2.5 | 36.70 | 38.65 | 40.60 | 1 | 53.3 | 7.5 | 375 | X |
| SZ1SMA36AT3G | SP | 36 | 2.5 | 40.00 | 42.10 | 44.20 | 1 | 58.1 | 6.9 | 345 | X |
| SZ1SMA40AT3G | SR | 40 | 2.5 | 44.40 | 46.75 | 49.10 | 1 | 64.5 | 6.2 | 315 | X |
| SZ1SMA43AT3G | ST | 43 | 2.5 | 47.80 | 50.30 | 52.80 | 1 | 69.4 | 5.8 | 295 | X |
| SZ1SMA45AT3G | SV | 45 | 2.5 | 50.00 | 52.65 | 55.30 | 1 | 72.2 | 5.5 | 280 | X |
| SZ1SMA48AT3G | SX | 48 | 2.5 | 53.30 | 56.10 | 58.90 | 1 | 77.4 | 5.2 | 265 | X |
| SZ1SMA51AT3G | SZ | 51 | 2.5 | 56.70 | 59.70 | 62.70 | 1 | 82.4 | 4.9 | 252 | - |
| SZ1SMA54AT3G | TE | 54 | 2.5 | 60.00 | 63.15 | 66.30 | 1 | 87.1 | 4.6 | 240 | X |
| SZ1SMA58AT3G | TG | 58 | 2.5 | 64.40 | 67.80 | 71.50 | 1 | 93.6 | 4.3 | 225 | X |
| SZ1SMA60AT3G | TK | 60 | 2.5 | 66.70 | 70.20 | 73.72 | 1 | 96.8 | 4.1 | 219 | - |
| SZ1SMA70AT3G | TP | 70 | 2.5 | 77.80 | 81.90 | 86.00 | 1 | 113.0 | 3.5 | 190 | X |
| SZ1SMA75AT3G | TR | 75 | 2.5 | 83.3 | 87.7 | 92.1 | 1 | 121.0 | 3.3 | 180 | - |
| SZ1SMA78AT3G | TT | 78 | 2.5 | 86.7 | 91.25 | 95.8 | 1 | 126.0 | 3.2 | 178 | - |
| SZ1SMA85AT3G | TV | 85 | 2.5 | 94.4 | 99.2 | 104 | 1 | 137.0 | 2.9 | 173 | - |
| SZ1SMA90AT3G | TX | 90 | 2.5 | 100 | 105.5 | 111 | 1 | 146.0 | 2.8 | 169 | - |
| SZ1SMA100AT3G | TZ | 100 | 2.5 | 111 | 117 | 123 | 1 | 162.0 | 2.5 | 162 | - |
| SZ1SMA110AT3G | VE | 110 | 2.5 | 122 | 128.5 | 135 | 1 | 177.0 | 2.3 | 155 | - |
| SZ1SMA120AT3G | VG | 120 | 2.5 | 133 | 140 | 147 | 1 | 193.0 | 2.1 | 148 | - |
| SZ1SMA130AT3G | VK | 130 | 2.5 | 144 | 151.5 | 159 | 1 | 209.0 | 1.9 | 142 | - |
| SZ1SMA150AT3G | VM | 150 | 2.5 | 167 | 176 | 185 | 1 | 243.0 | 1.7 | 127 | - |
| SZ1SMA160AT3G | VP | 160 | 2.5 | 178 | 187.5 | 197 | 1 | 259.0 | 1.6 | 119 | - |
| SZ1SMA170AT3G | VR | 170 | 2.5 | 189 | 199 | 209 | 1 | 275.0 | 1.5 | 112 | - |

Electrical Characteristics - For Bi-directional

| Device | Device Marking | V _{RWM} ^{Note 6} | I _R @ V _{RWM} | Breakdown Voltage | | | | V _C @ I _{PP} ^{Note 8} | | Agency Approval  |
|---------------|----------------|------------------------------------|-----------------------------------|--|-------|-------|------------------|--|-----------------|--|
| | | | | V _{BR} @ I _T (V) ^{Note 7} | | | @ I _T | V _C | I _{PP} | |
| | | | | MIN | NOM | MAX | mA | Volts | Amps | |
| SZ1SMA10CAT3G | QXC | 10 | 2.5 | 11.10 | 11.69 | 12.27 | 1 | 170 | 23.5 | X |
| SZ1SMA12CAT3G | REC | 12 | 2.5 | 13.30 | 14.00 | 14.70 | 1 | 19.9 | 20.1 | X |
| SZ1SMA13CAT3G | RGC | 13 | 2.5 | 14.40 | 15.16 | 15.92 | 1 | 21.5 | 18.6 | X |
| SZ1SMA15CAT3G | RMC | 15 | 2.5 | 16.70 | 17.58 | 18.46 | 1 | 24.4 | 16.4 | X |
| SZ1SMA16CAT3G | RPC | 16 | 2.5 | 17.80 | 18.74 | 19.67 | 1 | 26.0 | 15.4 | X |
| SZ1SMA18CAT3G | RTC | 18 | 2.5 | 20.00 | 21.06 | 22.11 | 1 | 29.2 | 13.7 | X |
| SZ1SMA20CAT3G | RVC | 20 | 2.5 | 22.20 | 23.37 | 24.54 | 1 | 32.4 | 12.3 | X |
| SZ1SMA22CAT3G | RXC | 22 | 2.5 | 24.4 | 25.65 | 26.90 | 1 | 35.5 | 11.3 | - |
| SZ1SMA24CAT3G | RZC | 24 | 2.5 | 26.70 | 28.11 | 29.51 | 1 | 38.9 | 10.3 | X |
| SZ1SMA26CAT3G | SEC | 26 | 2.5 | 28.90 | 30.42 | 31.94 | 1 | 42.1 | 9.5 | X |
| SZ1SMA28CAT3G | SGC | 28 | 2.5 | 31.10 | 32.74 | 34.37 | 1 | 45.4 | 8.8 | X |
| SZ1SMA30CAT3G | SKC | 30 | 2.5 | 33.30 | 35.06 | 36.81 | 1 | 48.4 | 8.3 | X |
| SZ1SMA33CAT3G | SMC | 33 | 2.5 | 36.70 | 38.63 | 40.56 | 1 | 53.3 | 7.5 | X |
| SZ1SMA36CAT3G | SPC | 36 | 2.5 | 40.00 | 42.11 | 44.21 | 1 | 58.1 | 6.9 | X |
| SZ1SMA40CAT3G | SRC | 40 | 2.5 | 44.40 | 46.74 | 49.07 | 1 | 64.5 | 6.2 | X |
| SZ1SMA43CAT3G | STC | 43 | 2.5 | 47.80 | 50.30 | 52.80 | 1 | 69.4 | 5.8 | - |
| SZ1SMA45CAT3G | SVC | 45 | 2.5 | 50.00 | 52.65 | 55.30 | 1 | 72.2 | 5.5 | - |
| SZ1SMA48CAT3G | SXC | 48 | 2.5 | 53.30 | 56.11 | 58.91 | 1 | 77.4 | 5.2 | X |
| SZ1SMA58CAT3G | TGC | 58 | 2.5 | 64.40 | 67.79 | 71.18 | 1 | 93.6 | 4.3 | X |
| SZ1SMA60CAT3G | TKC | 60 | 2.5 | 66.70 | 70.21 | 73.72 | 1 | 96.8 | 4.1 | X |
| SZ1SMA70CAT3G | TPC | 70 | 2.5 | 77.80 | 81.90 | 85.99 | 1 | 113.0 | 3.5 | X |
| SZ1SMA78CAT3G | TTC | 78 | 2.5 | 86.70 | 91.27 | 95.83 | 1 | 126.0 | 3.2 | X |

6. A transient suppressor is normally selected according to the working peak reverse voltage (V_{RWM}), which should be equal to or greater than the DC or continuous peak operating voltage level

7. V_{BR} measured at pulse test current I_T at an ambient temperature of 25°C

8. Surge current waveform per Figure 2 and derate per Figure 3

9. Bias voltage = 0 V, F = 1.0 MHz, T_J = 25°C.

Ratings and Characteristic Curves

Figure 1. Pulse Rating Curve

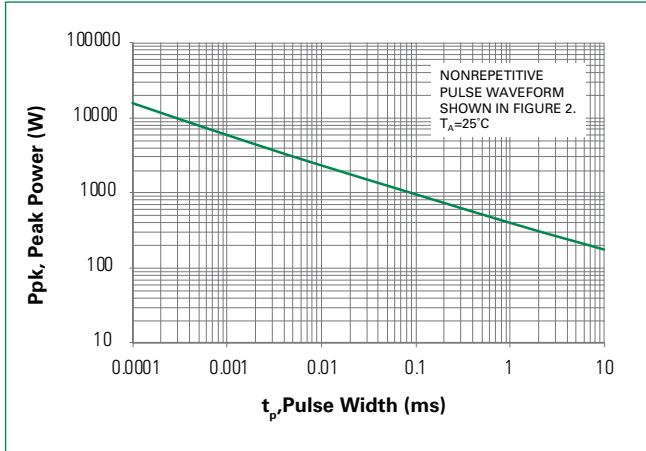

Figure 2. Pulse Waveform



Figure 3 - Surge Derating Curve

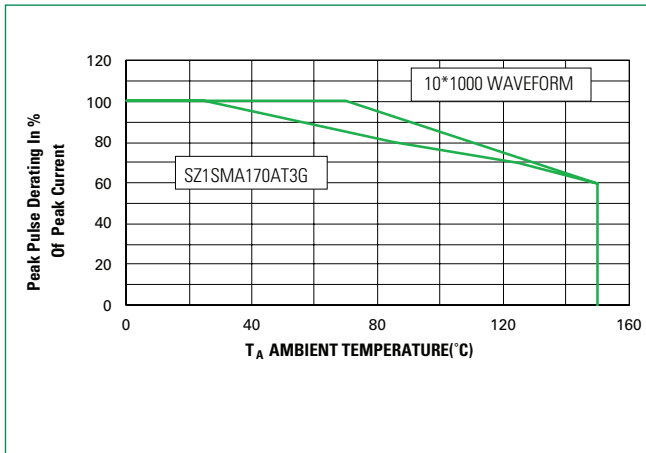

Figure 4. Typical Junction Capacitance vs. Bias Voltage



Figure 5. Typical Junction Capacitance vs. Bias Voltage

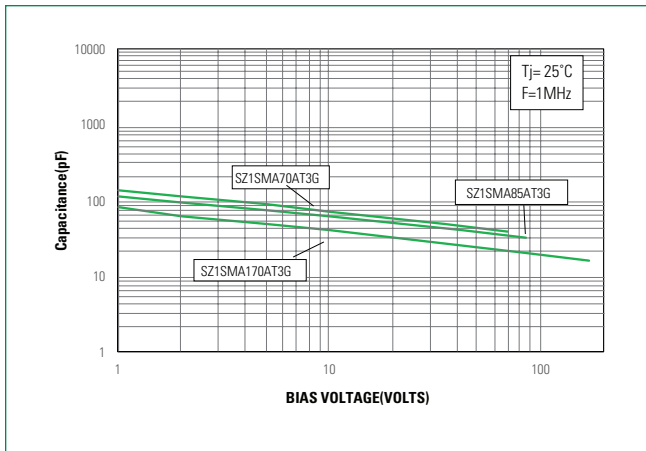

Figure 6. Steady State Power Derating



Soldering Parameters

| | | |
|--|------------------------------------|-------------------------|
| Reflow Condition | | Lead-free assembly |
| Pre Heat | - Temperature Min ($T_{s(min)}$) | 150°C |
| | - Temperature Max ($T_{s(max)}$) | 200°C |
| | - Time (min to max) (t_g) | 60 – 120 secs |
| Average ramp up rate (Liquidus Temp (T_L) to peak) | | 3°C/second max |
| $T_{s(max)}$ to T_L - Ramp-up Rate | | 3°C/second max |
| Reflow | - Temperature (T_L) (Liquidus) | 217°C |
| | - Time (min to max) (t_L) | 60 – 150 seconds |
| Peak Temperature (T_p) | | 260 ^{+0/-5} °C |
| Time within 5°C of actual peak Temperature (t_p) | | 30 seconds max |
| Ramp-down Rate | | 6°C/second max |
| Time 25°C to peak Temperature (T_p) | | 8 minutes max. |
| Do not exceed | | 260°C |



Physical Specifications

| | |
|-----------------|---|
| Weight | 0.00246 ounce, 0.0767 grams |
| Case | JEDEC DO214AC. Void-Free, Transfer-Molded, Thermosetting Plastic Epoxy Meets UL 94V-0 |
| Polarity | Color band denotes cathode for unidirectional components. |
| Terminal | Matte Tin-plated leads, Solderable per JESD22-B102 |

Environmental Specifications

| | |
|----------------------------|--------------------------|
| High Temp. Storage | JESD22-A103 |
| HTRB | JESD22-A108 |
| Temperature Cycling | JESD22-A104 |
| MSL | JEDEC-J-STD-020, Level 1 |
| H3TRB | JESD22-A101 |
| RSH | JESD22-A111 |

Soldering Footprint

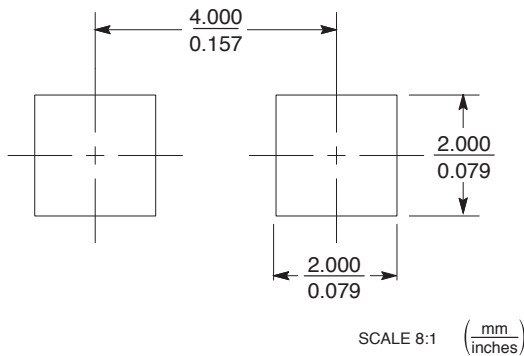

Dimensions

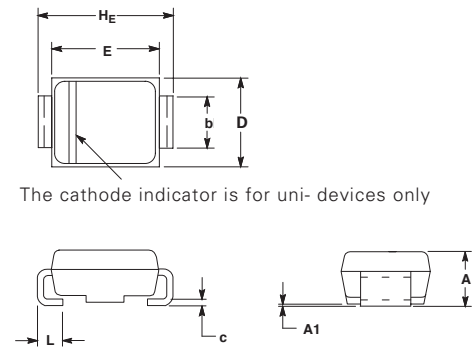

Ordering Information

| Device** | Package | Shipping |
|---------------|---------------|---------------------|
| SZ1SMAxxAT3G | SMA (Pb-Free) | 5,000 / Tape & Reel |
| SZ1SMAxxCAT3G | SMA (Pb-Free) | 5,000 / Tape & Reel |

**The "T3" suffix refers to a 13 inch reel

| Dim | Inches | | | Millimeters | | |
|----------------------|--------|-------|-------|-------------|------|------|
| | Min | Nom | Max | Min | Nom | Max |
| A | 0.078 | 0.083 | 0.087 | 1.97 | 2.10 | 2.20 |
| A1 | 0.002 | 0.004 | 0.008 | 0.05 | 0.10 | 0.20 |
| b | 0.050 | 0.057 | 0.064 | 1.27 | 1.45 | 1.63 |
| c | 0.006 | 0.011 | 0.016 | 0.15 | 0.28 | 0.41 |
| D | 0.090 | 0.103 | 0.115 | 2.29 | 2.60 | 2.92 |
| E | 0.160 | 0.170 | 0.180 | 4.06 | 4.32 | 4.57 |
| H_E | 0.190 | 0.205 | 0.220 | 4.83 | 5.21 | 5.59 |
| L | 0.030 | 0.045 | 0.060 | 0.76 | 1.14 | 1.52 |

Part Marking System



XXXX = Device Code (max four digits)
 Y = Year
 M = Month
 A = Assembly Location
 WW = Lot Code

Part Numbering System



Tape and Reel Specification



Looking for pricing, stock, or lifecycle information?

Click below to explore more details on WIN SOURCE:

 [View SZ1SMA85AT3G on WIN SOURCE](#)

 [Littelfuse Inc. Information](#)

Optimize Your Supply Chain with WIN SOURCE Solutions

-  Global Sourcing Solution
-  Obsolete Management
-  Cost Control Management
-  Shortage Management
-  Alternative Solution
-  Excess Inventory Management