



# THE DATASHEET OF HMC998APM5E



## GaAs pHEMT MMIC 2 WATT POWER AMPLIFIER, DC - 22 GHz

### Typical Applications

The HMC998APM5E is ideal for:

- Test Instrumentation
- Military & Space
- Fiber optics

### Features

- P1dB Output Power: +32 dBm
- Psat Output Power: +34 dBm
- High Gain: 15 dB
- Output IP3: 42 dBm
- Supply Voltage: Vdd = +15V @ 500 mA
- 50 Ohm Matched Input/Output
- 32 Lead 5x5 mm LFCSP Package: 25 mm<sup>2</sup>

### Functional Diagram

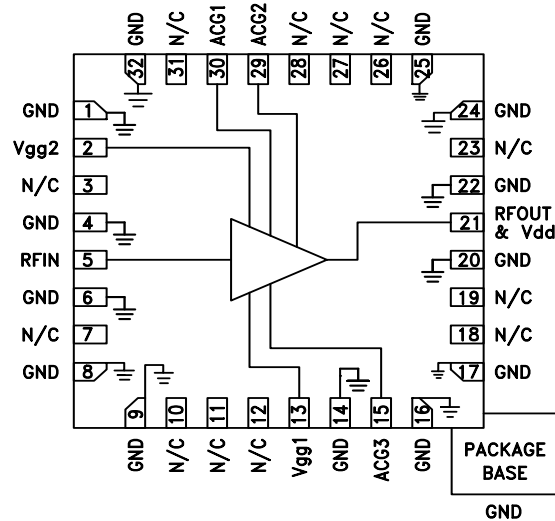

### General Description

The HMC998APM5E is a GaAs pHEMT MMIC Distributed Power Amplifier which operates from DC to 22 GHz. The amplifier provides +15 dB of gain, +42 dBm output IP3, and +32 dBm of output power at 1dB gain compression while requiring only 500mA from a +15V supply. The HMC998APM5E exhibits a slightly positive gain slope from 3 to 17 GHz making it ideal for military and space and test equipment applications. The HMC998APM5E amplifier I/Os are internally matched to 50 Ohms and is housed in a RoHS compliant, 5x5 mm leadless QFN surface mount package.

### Electrical Specifications, $T_A = +25^\circ C$ , $V_{dd} = +15V$ , $V_{gg2} = +9.5V$ [1], $I_{dq} = 500 mA$ [2]

| Parameter  | Min. | Typ.   | Max. | Min.   | Typ.  | Max. | Min.    | Typ.  | Max. | Units |
|--|------|--------|------|--------|-------|------|---------|-------|------|-------|
| Frequency Range  |      | DC - 2 |      | 2 - 18 |       |      | 18 - 22 |       |      | GHz   |
| Gain   | 13   | 15     |      | 13     | 15    |      | 13      | 15    |      | dB    |
| Gain Flatness  |      | ±0.50  |      |        | ±0.45 |      |         | ±0.30 |      | dB    |
| Gain Variation Over Temperature                          |      | 0.005  |      |        | 0.005 |      |         | 0.004 |      | dB/°C |
| Input Return Loss  |      | 15     |      |        | 22    |      |         | 22    |      | dB    |
| Output Return Loss                                       |      | 14     |      |        | 17    |      |         | 16    |      | dB    |
| Output Power for 1 dB Compression (P1dB)                 | 27   | 30     |      | 29     | 32    |      | 28      | 31    |      | dBm   |
| Saturated Output Power (Psat)                            |      | 34     |      |        | 34    |      |         | 32    |      | dBm   |
| Output Third Order Intercept (IP3)<br>Pout/tone = +18dBm |      | 42     |      |        | 42    |      |         | 40    |      | dBm   |
| Noise Figure   |      | 8      |      |        | 3     |      |         | 4     |      | dB    |
| Supply Current (Idd)                                     |      | 500    |      |        | 500   |      |         | 500   |      | mA    |
| Supply Voltage (Vdd)                                     | 11   | 15     | 15   | 11     | 15    | 15   | 11      | 15    | 15   | V     |

[1] Refer to application circuit section NOTE 5 for the Vgg2 bias for different Vdd levels.

[2] Adjust Vgg1 to achieve Idq = 500 mA typical; Vgg1 = -0.58V typical.

Product covered by one or more US and Foreign Patents: US Pat. Nos. 8,786,368; 9,425,752; Patents Pending.

**GaAs pHEMT MMIC  
2 WATT POWER AMPLIFIER, DC - 22 GHz**

**Low Frequency Gain & Return Loss**

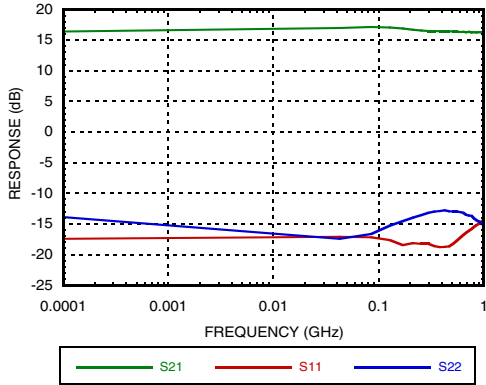

**Gain & Return Loss**

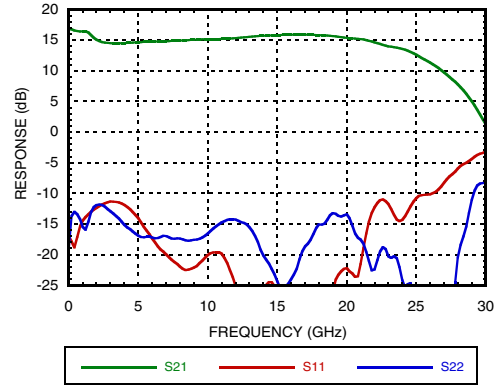

**Gain vs. Temperature**

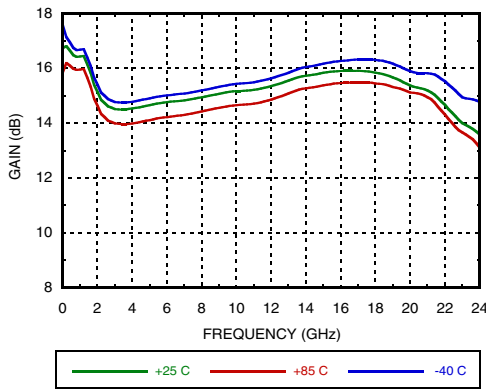

**Gain vs. Vdd**

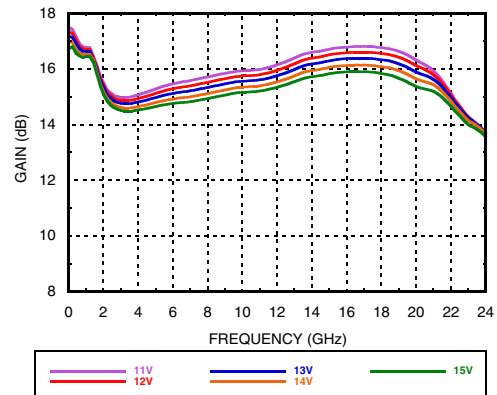

**Gain vs. Idq**

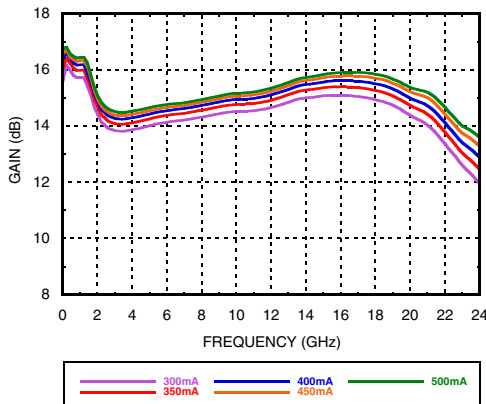

**Input Return Loss vs. Temperature**

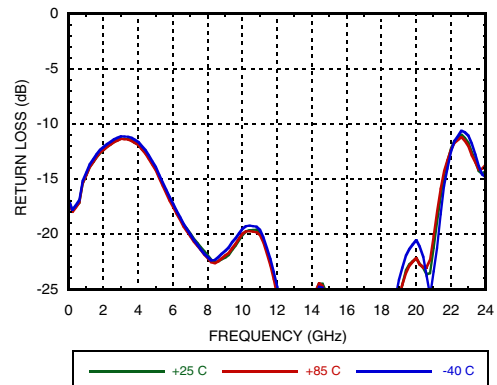

**GaAs pHEMT MMIC  
2 WATT POWER AMPLIFIER, DC - 22 GHz**

**Input Return Loss vs. Vdd**

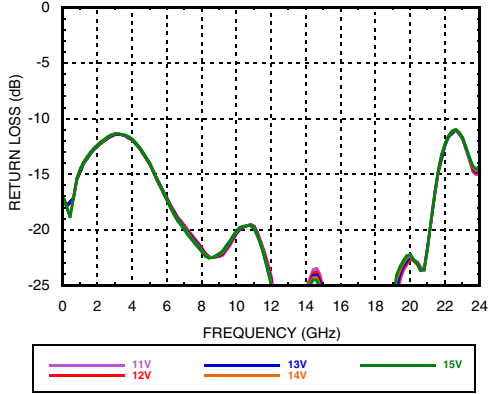

**Input Return Loss vs. Idq**

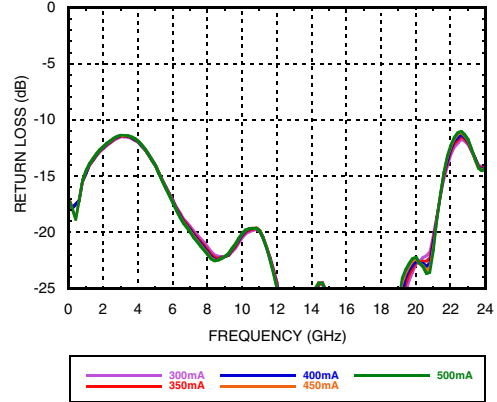

**Output Return Loss vs. Temperature**

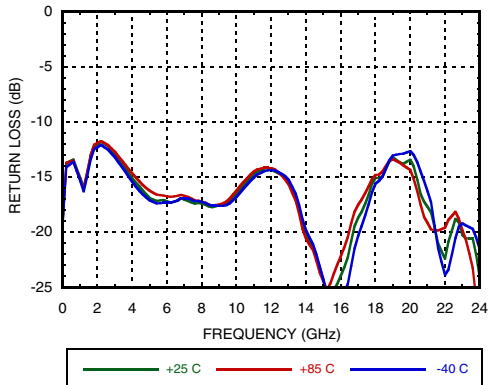

**Output Return Loss vs. Vdd**

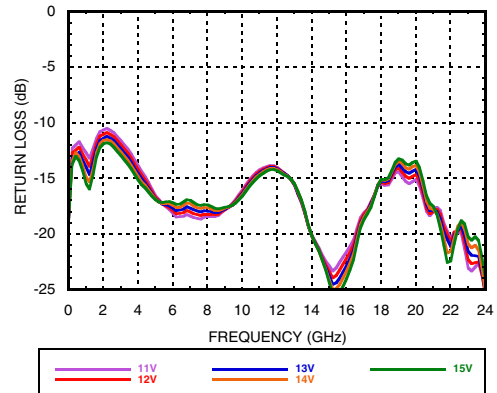

**Output Return Loss vs. Idq**

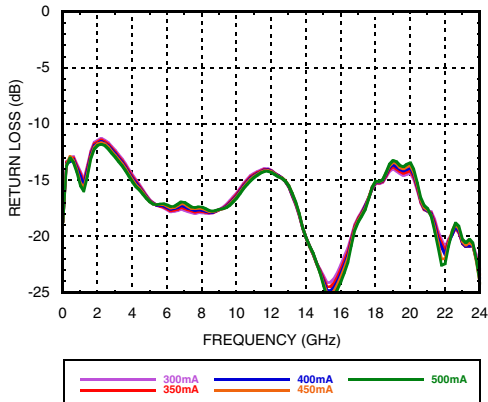

**Reverse Isolation vs. Temperature**

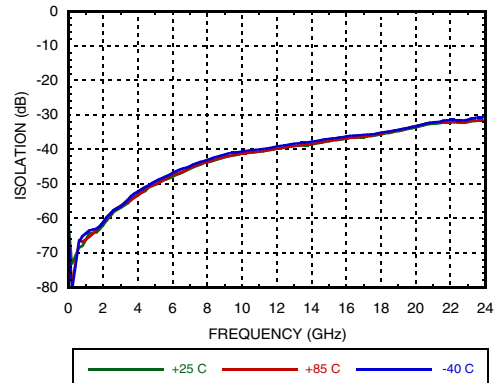

**GaAs pHEMT MMIC  
2 WATT POWER AMPLIFIER, DC - 22 GHz**

**Noise Figure vs. Temperature**

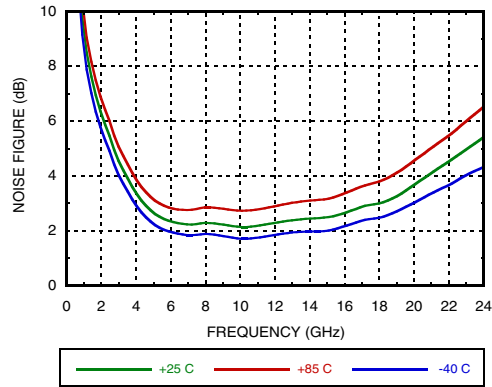

**Noise Figure vs. Vdd**

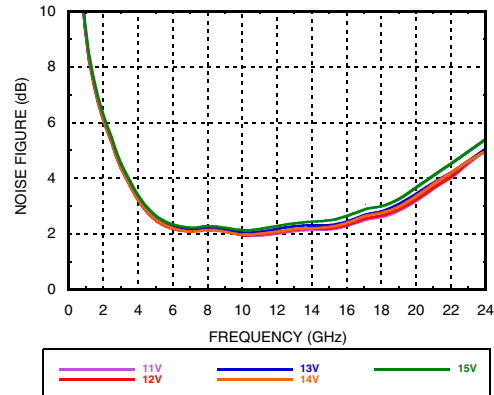

**Noise Figure vs. Idq**

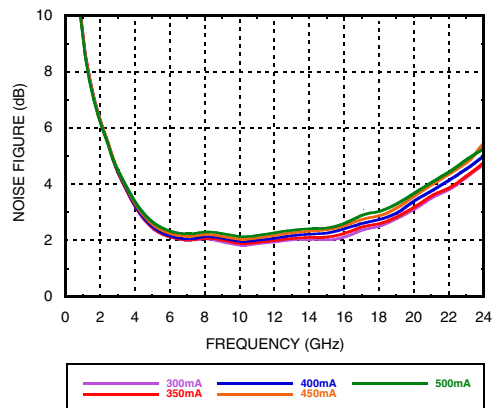

**Low Frequency P1dB vs. Temperature**

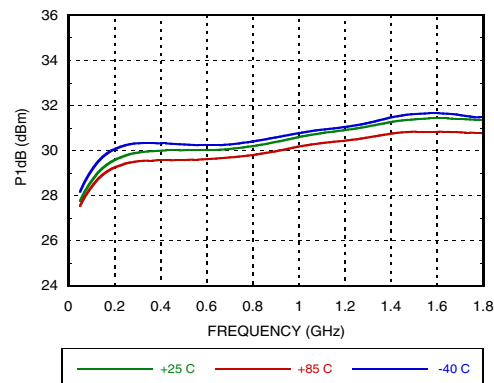

**P1dB vs. Temperature**

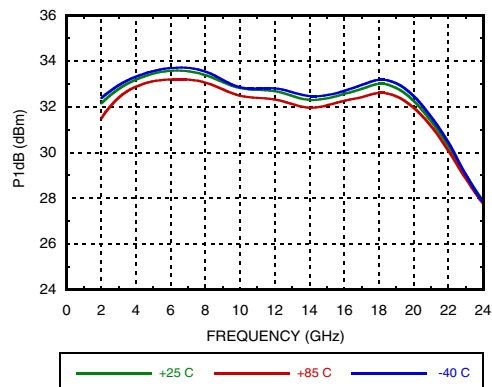

**P1dB vs. Vdd**

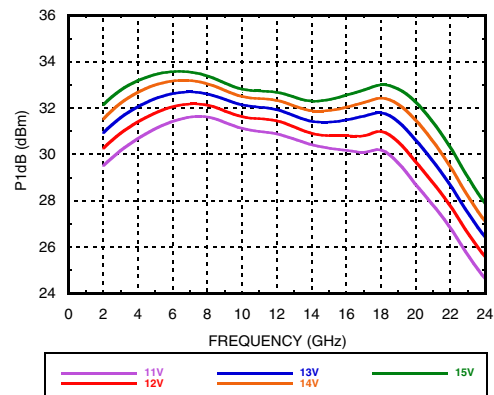

**GaAs pHEMT MMIC  
2 WATT POWER AMPLIFIER, DC - 22 GHz**

**P1dB vs. Idq**

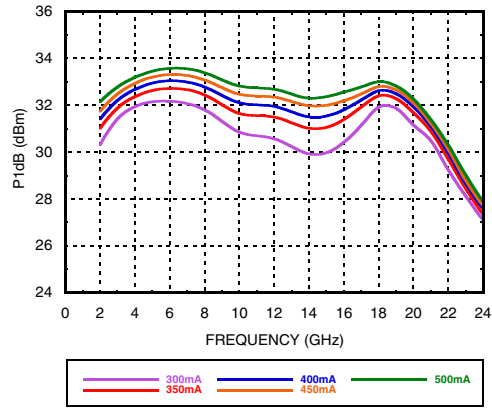

**Low Frequency Psat vs. Temperature**

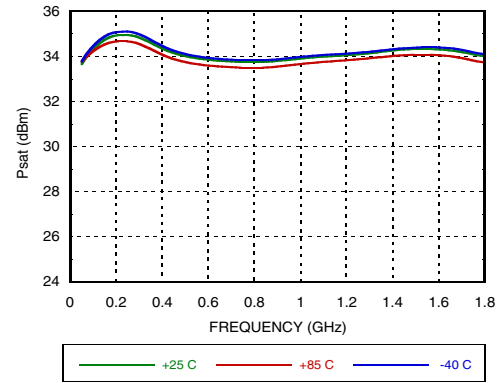

**Psat vs. Temperature**

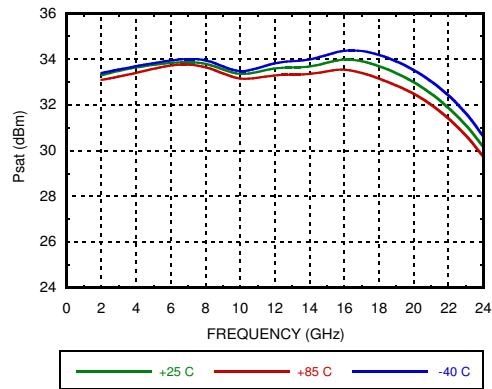

**Psat vs. Vdd**

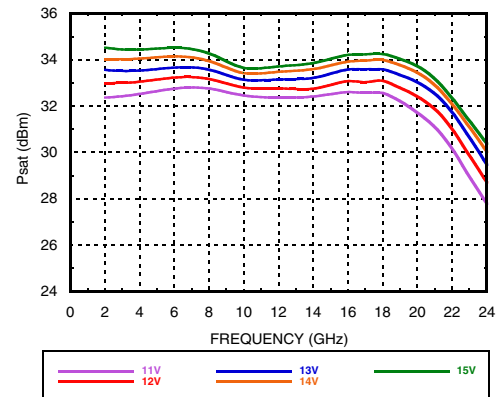

**Psat vs. Idq**

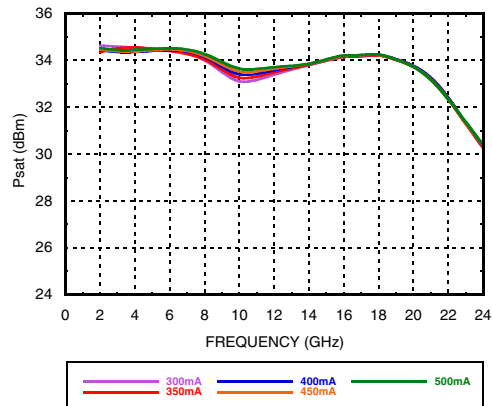

**PAE @ Psat vs. Temperature**

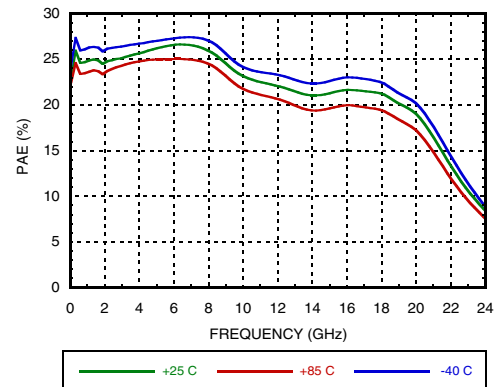

**GaAs pHEMT MMIC  
2 WATT POWER AMPLIFIER, DC - 22 GHz**

**PAE @ Psat vs. Vdd**

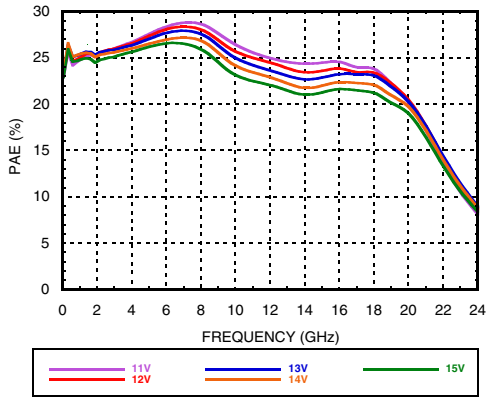

**PAE @ Psat vs. Idq**

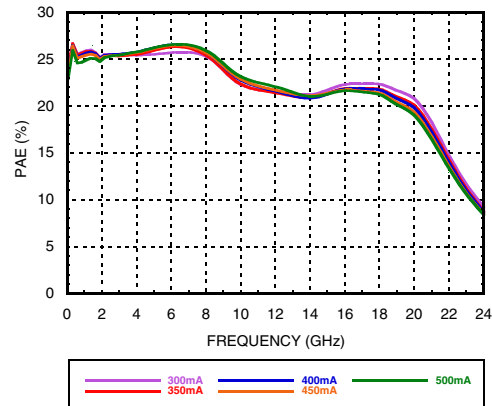

**Power Compression @ 2 GHz**

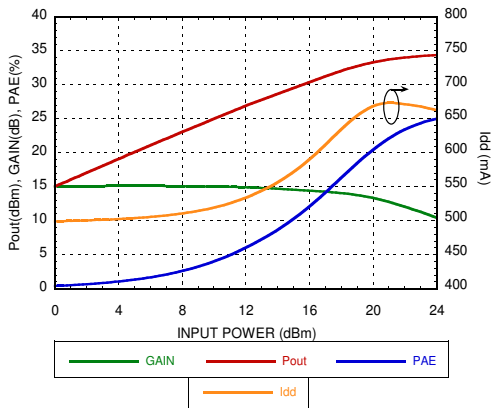

**Power Compression @ 10 GHz**

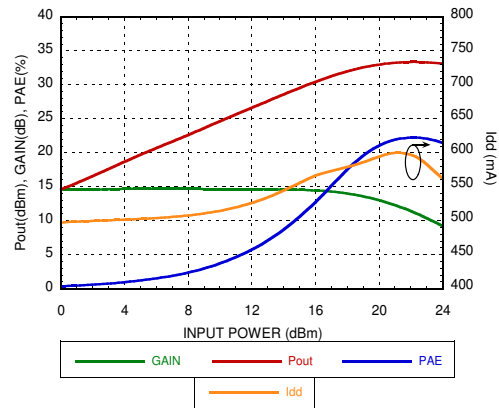

**Power Compression @ 22 GHz**

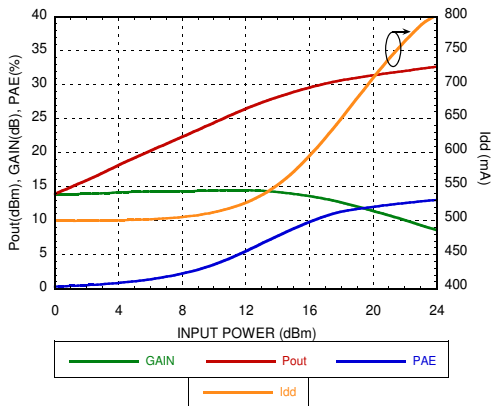

**Power Dissipation @ 85C**

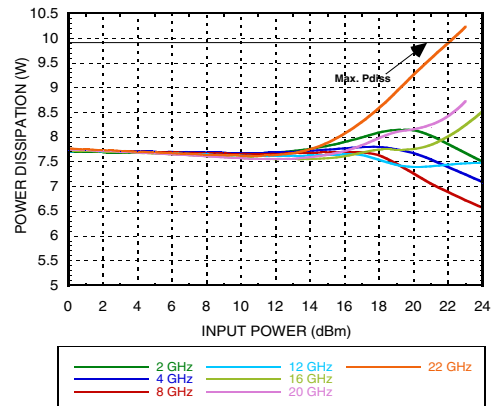

**GaAs pHEMT MMIC  
2 WATT POWER AMPLIFIER, DC - 22 GHz**

**Gain & Power vs. Vdd @ 2 GHz**

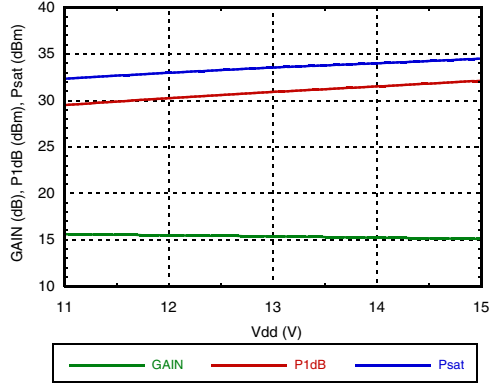

**Gain & Power vs. Vdd @ 10 GHz**

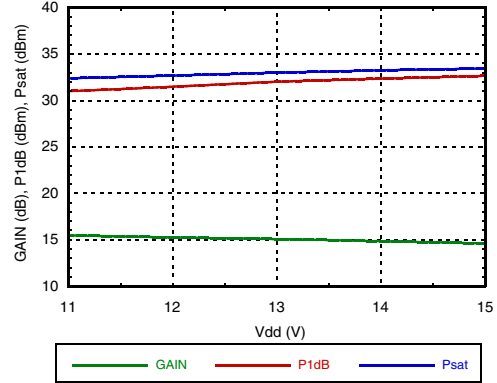

**Gain & Power vs. Vdd @ 22 GHz**

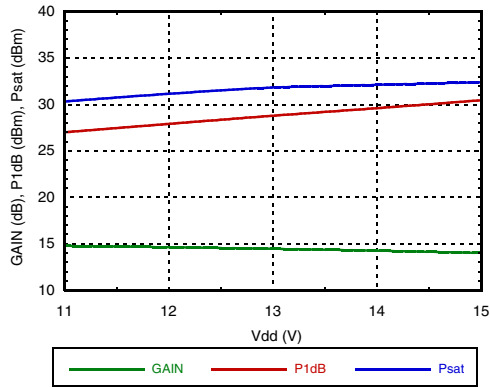

**Gain & Power vs. Idq @ 2 GHz**

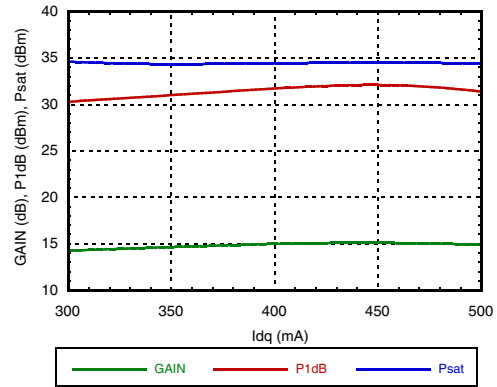

**Gain & Power vs. Idq @ 10 GHz**

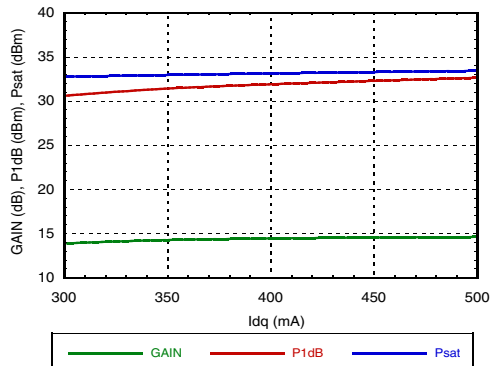

**Gain & Power vs. Idq @ 22 GHz**

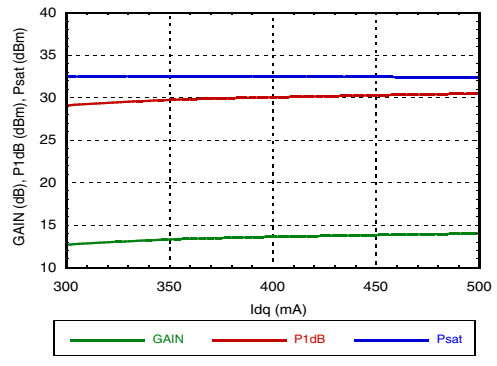

**GaAs pHEMT MMIC  
2 WATT POWER AMPLIFIER, DC - 22 GHz**

**Low Frequency OIP3 vs. Temperature  
@ Pout/Tone = +18dBm**

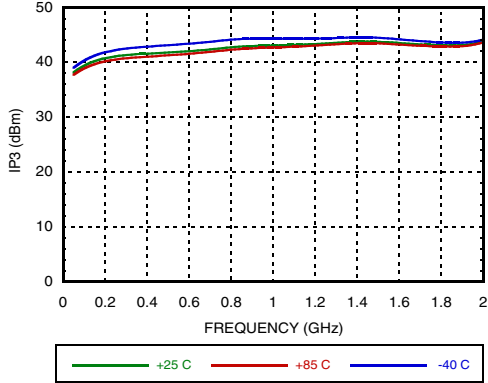

**OIP3 vs. Temperature  
@ Pout/Tone = +18dBm**

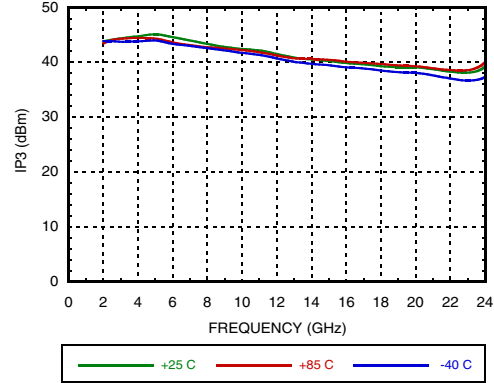

**OIP3 vs. Vdd @ Pout/Tone = +18dBm**

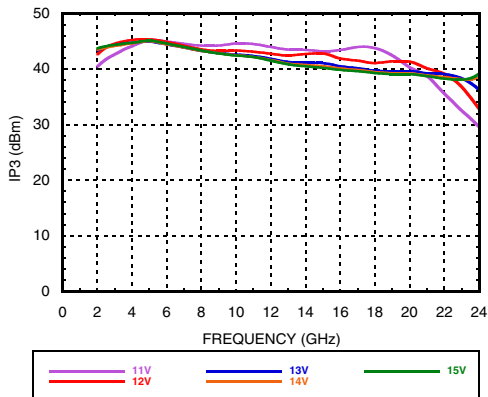

**OIP3 vs. Idq @ Pout/Tone = +18dBm**

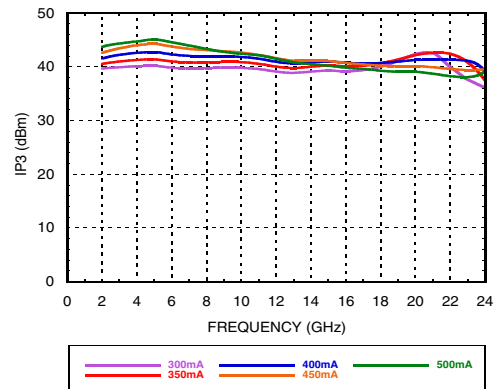

**Output IM3 @ Vdd = +11V**

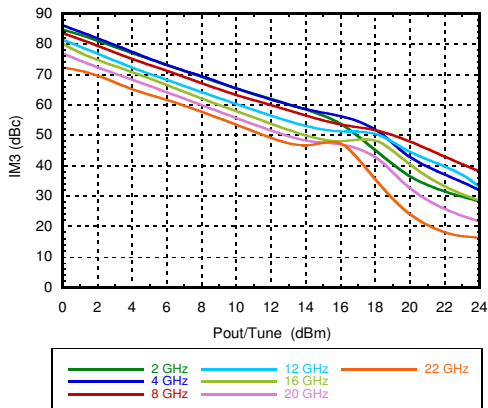

**Output IM3 @ Vdd = +12V**

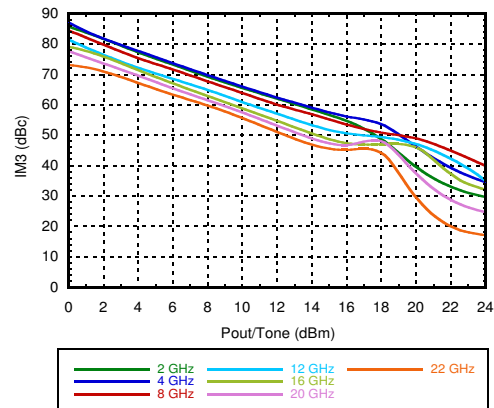

**GaAs pHEMT MMIC  
2 WATT POWER AMPLIFIER, DC - 22 GHz**

**Output IM3 @ Vdd = +13V**

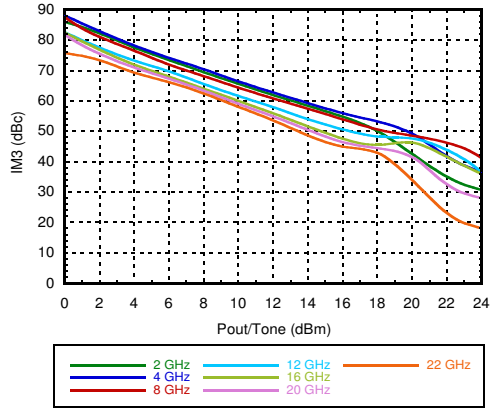

**Output IM3 @ Vdd = +14V**

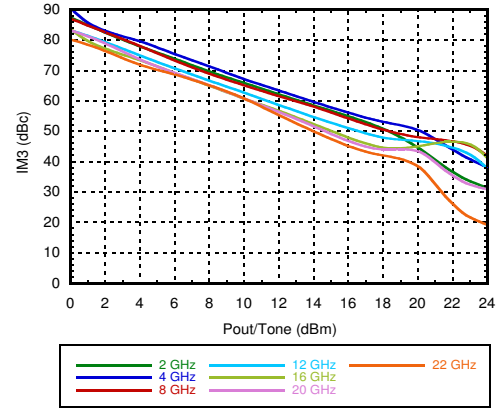

**Output IM3 @ Vdd = +15V**

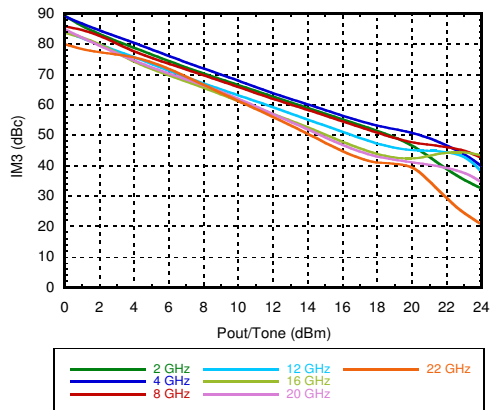

**Second Harmonics vs. Temperature  
@ Pout = +18dBm**

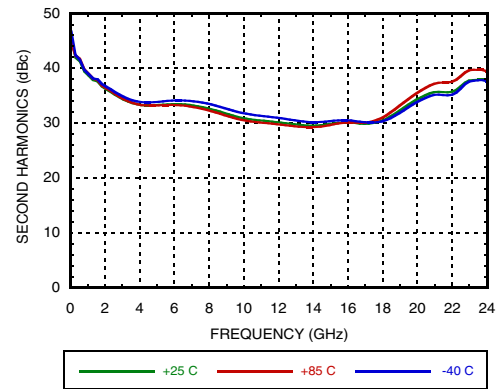

**Second Harmonics vs. Vdd  
@ Pout = +18dBm**

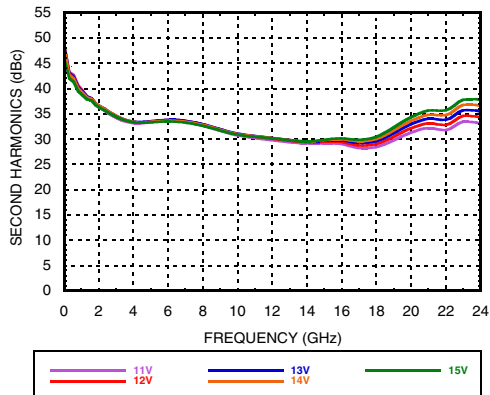

**Second Harmonics vs. Pout**

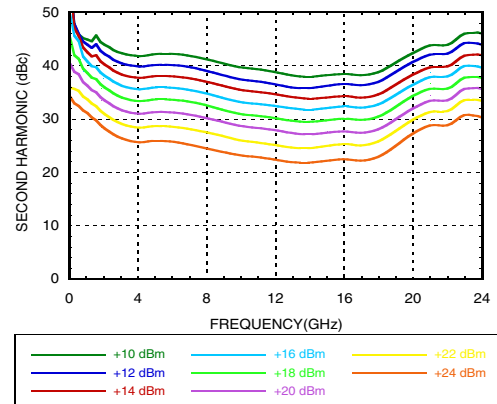

**GaAs pHEMT MMIC  
2 WATT POWER AMPLIFIER, DC - 22 GHz**

**OIP2 vs. Temperature  
@ Pout/Tone = +18dBm**

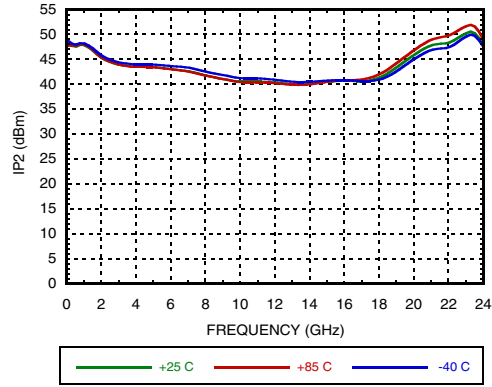

**OIP2 vs. Vdd @ Pout/Tone = +18dBm**

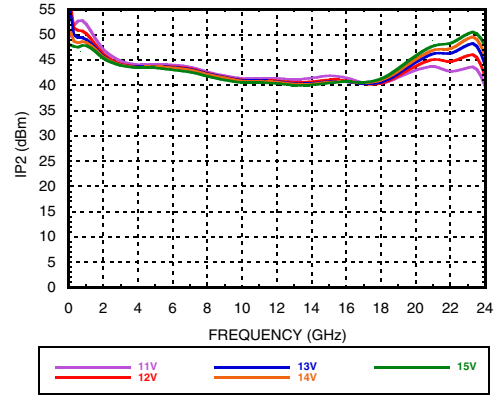

**OIP2 vs. Idq @ Pout/Tone = +18dBm**

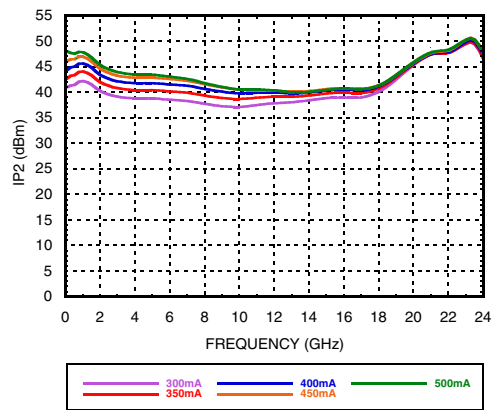

**Igg1 vs. Input Power**

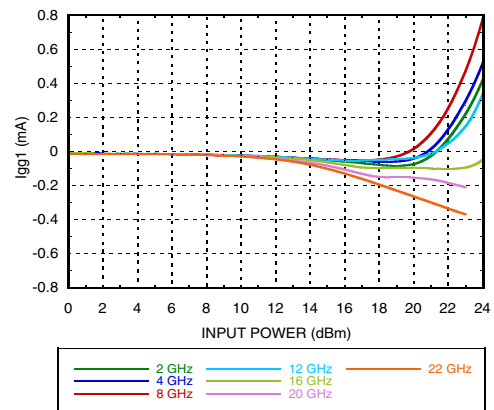

**Igg2 vs. Input Power**

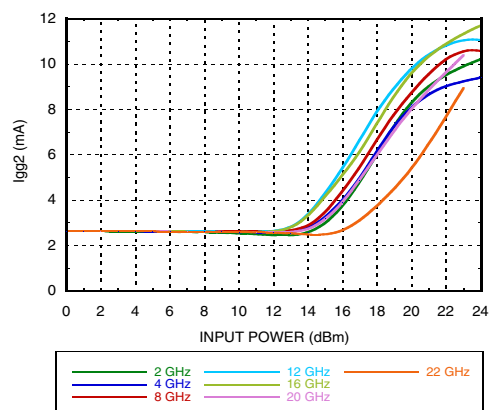

**Idq vs. Vgg1  
Representative of a Typical Device**

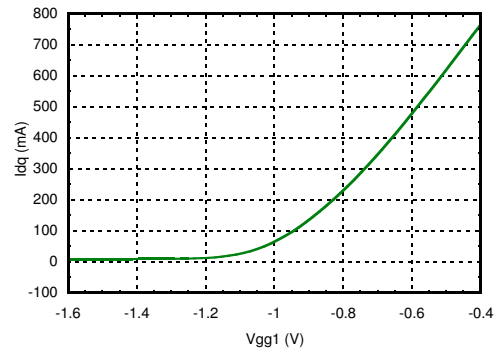

## GaAs pHEMT MMIC 2 WATT POWER AMPLIFIER, DC - 22 GHz

### Absolute Maximum Ratings

|  |                          |
|--|--------------------------|
| Drain Bias Voltage (Vdd)   | +16 Vdc                  |
| Gate Bias Voltage (Vgg1)   | -3 to 0 Vdc              |
| Gate Bias Voltage (Vgg2)   | (Vdd-6V) up to +11.5 Vdc |
| RF Input Power (RFIN)  | +27 dBm                  |
| Continuous Pdiss (T= 85 °C)<br>(derate 109.89 mW/°C above 85 °C) | 9.9 W                    |
| Output Load VSWR   | 7:1                      |
| Storage Temperature  | -65 to 150°C             |
| Operating Temperature  | -40 to 85 °C             |
| ESD Sensitivity (HBM)  | Class 1A                 |
| Max Peak Reflow Temperature                                      | 260 °C                   |

### Reliability Information

|   |          |
|---|----------|
| Channel Temperature to Maintain 1 Million Hour MTTF | 175 °C   |
| Nominal Channel Temperature (T=85 °C, Vdd = 15 V)   | 153.25°C |
| Thermal Resistance (channel to ground paddle)       | 9.1 °C/W |



**ELECTROSTATIC SENSITIVE DEVICE  
OBSERVE HANDLING PRECAUTIONS**

Stresses at or above those listed under Absolute Maximum Ratings may cause permanent damage to the product. This is a stress rating only, functional operation of the product at these or any other conditions above those indicated in the operational section of this specification is not implied. Operation beyond the maximum operating conditions for extended periods may affect product reliability.

### Outline Drawing

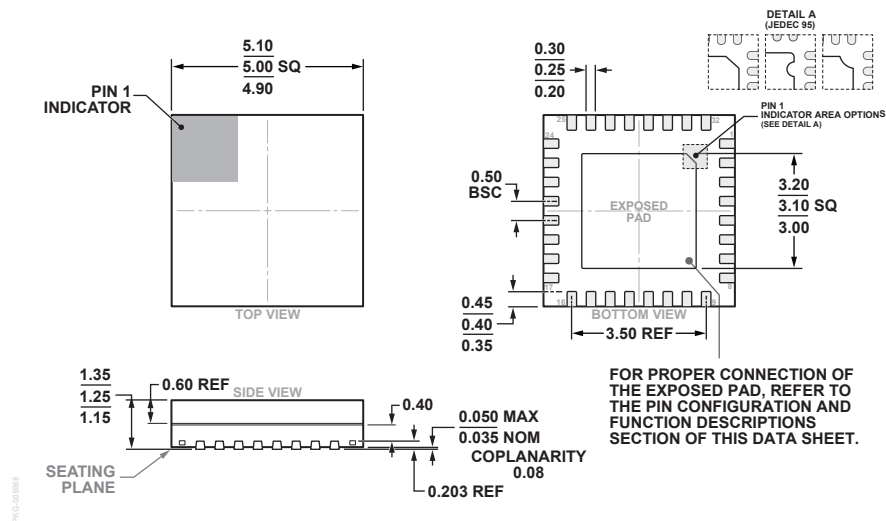

### Package Information

| Part Number | Package Body Material                        | Lead Finish | MSL Rating <sup>[1]</sup> | Package Marking |
|-------------|--|-------------|---------------------------|-----------------|
| HMC998APM5E | RoHS-compliant Low Stress Pre-Molded Plastic | NiPdAu      | MSL3                      | HMC998A         |

[1] Max peak reflow temperature of 260 °C

## GaAs pHEMT MMIC 2 WATT POWER AMPLIFIER, DC - 22 GHz

### Pin Descriptions

| Pin Number  | Function    | Description  | Interface Schematic |
|---|-------------|--|---------------------|
| 1, 4, 6, 8, 9, 14, 16, 17, 20, 22, 24, 25, 32<br>Package Bottom | GND         | These pins & exposed ground paddle must be connected to RF/DC ground.  |                     |
| 2   | VGG2        | Gate control 2 for amplifier. External bypass capacitor required per application circuit herein. For nominal bias of 15V, +9.5V should be applied to Vgg2. Refer to application circuit section NOTE 5 for the Vgg2 bias for different Vdd levels. |                     |
| 3, 7, 10, 11, 12, 18, 19, 23, 26, 27, 28, 31                    | N/C         | No connection required. These pins may be connected to RF/DC ground without affecting performance.   |                     |
| 5   | RFIN        | This pin is DC coupled and matched to 50 Ohms. Blocking capacitor is required.   |                     |
| 13  | VGG1        | Gate control 1 for amplifier. Attach bypass capacitor per application circuit herein. Please follow "MMIC Amplifier Biasing Procedure" application note.   |                     |
| 15  | ACG3        | Low Frequency termination. Attach bypass capacitor per application circuit herein.   |                     |
| 21  | RFOUT & Vdd | RF output for amplifier. Connect DC bias (Vdd) network to provide drain current (Idd). See application circuit herein.   |                     |
| 29  | ACG2        | Low frequency termination. Attach bypass capacitor per application circuit herein  |                     |
| 30  | ACG1        |  |                     |

## GaAs pHEMT MMIC 2 WATT POWER AMPLIFIER, DC - 22 GHz

### Evaluation PCB

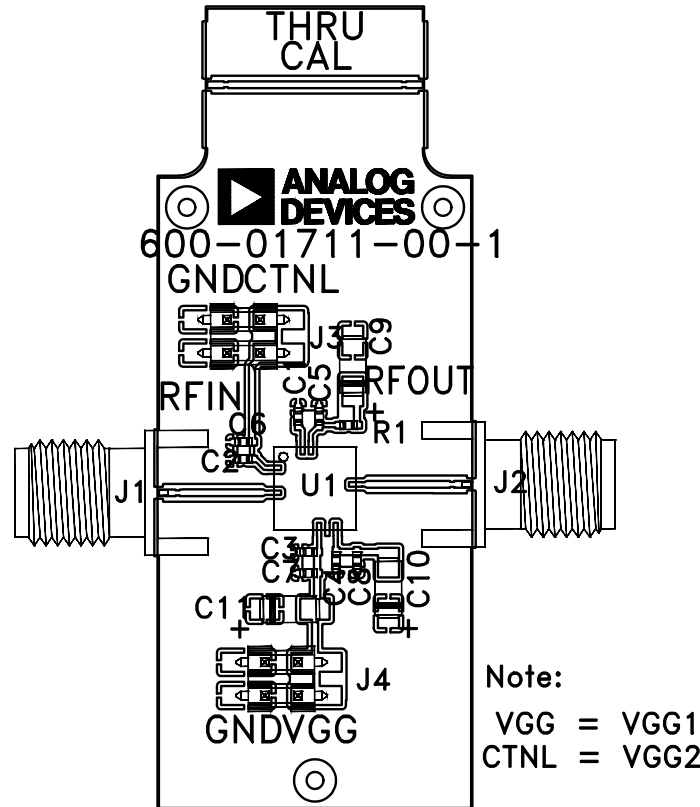

### Evaluation Order Information

| Item                | Contents                   | Part Number                  |
|---------------------|----------------------------|------------------------------|
| Evaluation PCB Only | HMC998APM5E Evaluation PCB | EV1HMC998APM5 <sup>[1]</sup> |

[1] Reference this number when ordering Evaluation PCB Only

### List of Materials for Evaluation Board EV1HMC998APM5

| Item               | Description                  |
|--------------------|------------------------------|
| J1, J2             | PCB Mount K Connector        |
| J3, J4             | DC Pins Connector            |
| C1, C2, C3, C4     | 100pF Capacitor, 0402 Pkg.   |
| C5 - C8            | 0.01uF Capacitor, 0402 Pkg.  |
| C9 - C11           | 4.7 uF Capacitor, Tantalum.  |
| R1                 | 0 Ohm Resistor, 0402 Pkg.    |
| U1                 | HMC998APM5E                  |
| PCB <sup>[1]</sup> | 600-01711-00 Evaluation PCB. |

[1] Circuit Board Material: Rogers 4350 or Arlon 25FR

The circuit board used in the application should use RF circuit design techniques. Signal lines should have 50 Ohm impedance while the package ground leads and exposed paddle should be connected directly to the ground plane similar to that shown. A sufficient number of vias should be used to connect the top and bottom ground planes, including the grounds directly beneath the ground paddle, to provide for adequate electrical and thermal conduction. Use of a heatsink on the bottom side of the PCB is recommended.

**GaAs pHEMT MMIC  
2 WATT POWER AMPLIFIER, DC - 22 GHz**

**Application Circuit**

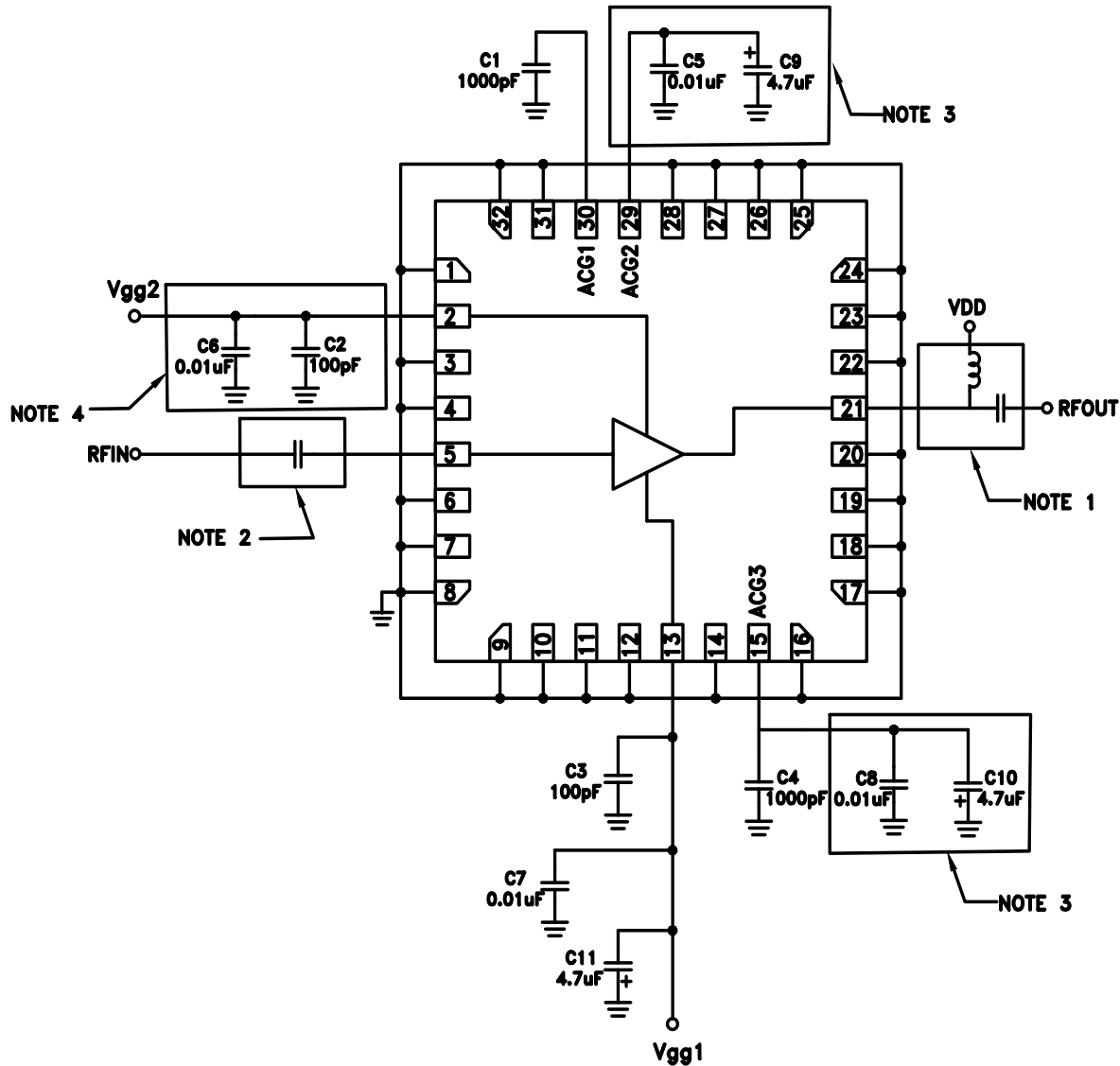

- NOTE 1: Drain Bias (Vdd) must be applied through a broadband bias tee or external bias network.
- NOTE 2: External DC block required at RF input.
- NOTE 3: Optional capacitors to be used if part is to be operated below 200MHz.
- NOTE 4: External capacitors required to maintain nominal gain at low frequency band.
- NOTE 5: Refer to table below for the recommended Vgg2 bias for different Vdd supply voltage.

| Vdd (V) | Vgg2 (V) |
|---------|----------|
| 11      | 7        |
| 12      | 7.6      |
| 13      | 8.2      |
| 14      | 8.9      |
| 15      | 9.5      |

## Looking for pricing, stock, or lifecycle information?

Click below to explore more details on WIN SOURCE:

 [View HMC998APM5E on WIN SOURCE](#)

 [Analog Devices Inc. Information](#)

## Optimize Your Supply Chain with WIN SOURCE Solutions

-  Global Sourcing Solution
-  Obsolete Management
-  Cost Control Management
-  Shortage Management
-  Alternative Solution
-  Excess Inventory Management