



**THE DATASHEET OF
E48SH3R330NRFA**



FEATURES



Photo is for reference only

E48SH3R330

1/8 Brick DC/DC Power Module

36~75Vin, 3.3Vout, 30A

E48SH3R330, Eighth Brick, 48V input, single output, isolated DC/DC converters, from a world leader in power systems technology and manufacturing — Delta Electronics, Inc., is available in either a through-hole or surface-mounted package and provides up to 120 watts of power or 50A of output current (1.2V and below) in an industry standard footprint and pinout. The E48SH converter operates from an input voltage of 36V to 75V and is available in output voltages from 1.0V to 15V. Efficiency is up to 92.0% for 3.3V output at 30A full load. With creative design technology and optimization of component placement, these converters possess outstanding electrical and thermal performance, as well as extremely high reliability under highly stressful operating conditions. All models are fully protected from abnormal input/output voltage, current, and temperature conditions. The E48SH Series converters meet all safety requirements with basic insulation.

Electrical

- High efficiency: 92.0% @3.3V/30A
- Fixed frequency operation
- Input UVLO, Output OTP, OCP, OVP
- Monotonic startup into normal and pre-biased loads
- Secondary control, very fast transient response
- 2250V Isolation and basic insulation
- No minimum load required
- No negative current during power or enable on/off

Mechanical

Size (W/O heat-spreader):

58.4mm x 22.8mm x9.5mm
(2.30"x0.90"x0.37")

Size (With heat-spreader)

58.4mm x 22.8mm x12.7mm
(2.30"x0.90"x0.50")

- Industry standard pin out
- SMD and through-hole versions

Safety & Reliability

- IEC/EN/UL/CSA 62368-1, 2nd edition
- IEC/EN/UL/CSA 60950-1, 2nd edition+A2
- ISO 9001, TL 9000, ISO 14001, QS 9000, OHSAS18001 certified manufacturing facility

OPTIONS

- Positive On/Off logic
- Open frame/Heat-spreader
- External Synchronization
- Output OVP latch mode
- Output OCP latch mode

SOLDERING METHOD

- Wave soldering
- Hand soldering
- Reflow soldering

(T_A=25°C, airflow rate=300 LFM unless otherwise noted.)

PARAMETER	NOTES and CONDITIONS	E48SH3R330 (Standard)			
		Min.	Typ.	Max.	Units
ABSOLUTE MAXIMUM RATINGS					
Input Voltage					
Continuous				75	Vdc
Transient (100ms)	100mS			100	Vdc
Operating Ambient Temperature		-40		85	°C
Storage Temperature		-55		125	°C
Input/Output Isolation Voltage				2250	Vdc
INPUT CHARACTERISTICS					
Operating Input Voltage		36	48	75	Vdc
Input Under-Voltage Lockout					
Turn-On Voltage Threshold		33	34	35	Vdc
Turn-Off Voltage Threshold		31	32	33	Vdc
Lockout Hysteresis Voltage		1	2	3	Vdc
Maximum Input Current	100% Load, 36Vin			3.6	A
No-Load Input Current			50	120	mA
Off Converter Input Current			3	10	mA
Inrush Current(I ² t)				1	A2s
Input Reflected-Ripple Current	P-P thru 12µH inductor, 5Hz to 20MHz		25		mA
Input Voltage Ripple Rejection	120 Hz		50		dB
OUTPUT CHARACTERISTICS					
Output Voltage Set Point	Vin=48V, Io=Io,max, Tc=25°C	3.267	3.300	3.333	Vdc
Output Voltage Regulation					
Over Load	Io=Io,min to Io,max		±3	±10	mV
Over Line	Vin=36V to 75V		±3	±10	mV
Over Temperature	Tc=-40°C to 115°C			±15	mV
Total Output Voltage Range	over sample load, line and temperature	3.23		3.37	V
Output Voltage Ripple and Noise	5Hz to 20MHz bandwidth				
Peak-to-Peak	Full Load, 1µF ceramic, 10µF tantalum		30	60	mV
RMS	Full Load, 1µF ceramic, 10µF tantalum		10	20	mV
Operating Output Current Range		0		30	A
Output DC Current-Limit Inception	Output Voltage 10% Low	110		140	%
DYNAMIC CHARACTERISTICS					
Output Voltage Current Transient	48V, 10µF Tan & 1µF Ceramic load cap, 0.1A/µs				
Positive Step Change in Output Current	50% Io,max to 75% Io,max		60		mV
Negative Step Change in Output Current	75% Io,max to 50% Io,max		60		mV
Settling Time (within 1% Vout nominal)			30		us
Turn-On Transient					
Start-Up Time, From On/Off Control			15		ms
Start-Up Time, From Input			15		ms
Maximum Output Capacitance	Full load; no overshoot of Vout at startup			10000	µF
EFFICIENCY					
100% Load			92		%
60% Load			92.5		%
ISOLATION CHARACTERISTICS					
Input to Output				2250	Vdc
Isolation Resistance				10	MΩ
FEATURE CHARACTERISTICS					
Switching Frequency			250		kHz
ON/OFF Control, Negative Remote On/Off logic					
Logic Low (Module On)	Von/off at Ion/off=1.0mA	0		1.2	V
Logic High (Module Off)	Von/off at Ion/off=0.0 µA	3		50	V
ON/OFF Control, Positive Remote On/Off logic					
Logic Low (Module Off)	Von/off at Ion/off=1.0mA	0		1.2	V
Logic High (Module On)	Von/off at Ion/off=0.0 µA	3		50	V
ON/OFF Current (for both remote on/off logic)	Ion/off at Von/off=0.0V			1	mA
Leakage Current (for both remote on/off logic)	Logic High, Von/off=15V			50	µA
Output Voltage Trim Range	Across Pins 9 & 5, Pout ≤ max rated power	-20		10	%
Output Voltage Remote Sense Range	Pout ≤ max rated power			10	%
Output Over-Voltage Protection	Over full temp range; % of nominal Vout	118		130	%
GENERAL SPECIFICATIONS					
CMTBF	Io=80% of Io, max; Ta=25°C, airflow rate=300FLM		4.1		M hours
Weight	Without heat spreader		25		grams
Weight	With heat spreader		36.5		grams
Over-Temperature Shutdown (Without heat spreader)	Refer to Figure 21 for Hot spot 1 location		135		°C
Over-Temperature Shutdown (With heat spreader)	Refer to Figure 23 for Hot spot 2 location		129		°C
Over-Temperature Shutdown (NTC resistor)			132		°C

Note: Please attach thermocouple on NTC resistor to test OTP function, the hot spots' temperature is just for reference.

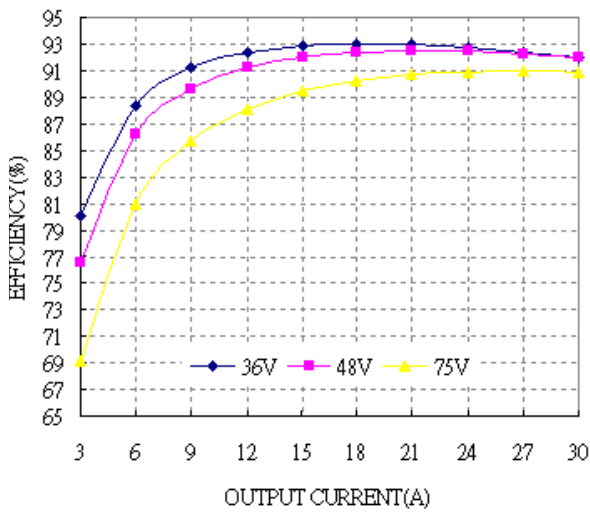

Figure 1: Efficiency vs. load current for minimum, nominal, and maximum input voltage at 25°C

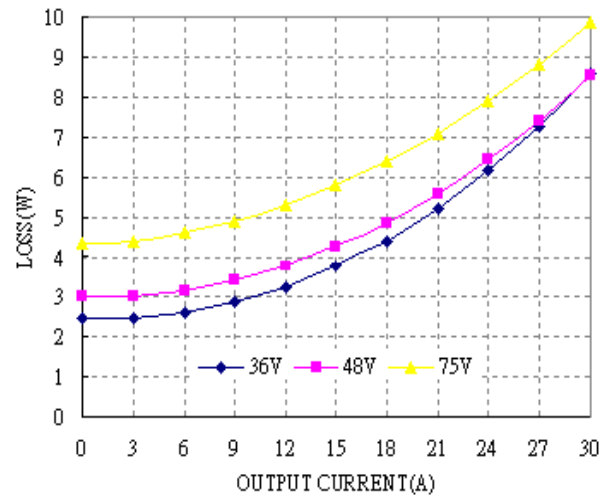

Figure 2: Power dissipation vs. load current for minimum, nominal, and maximum input voltage at 25°C

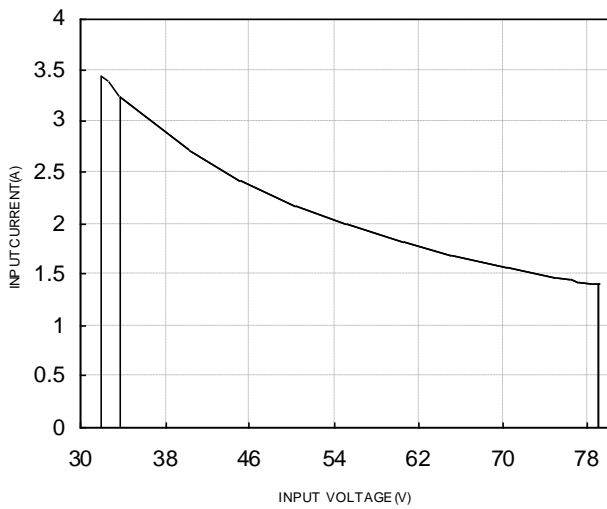

Figure 3: Typical full load input characteristics at room temperature

For Negative Remote On/Off Logic

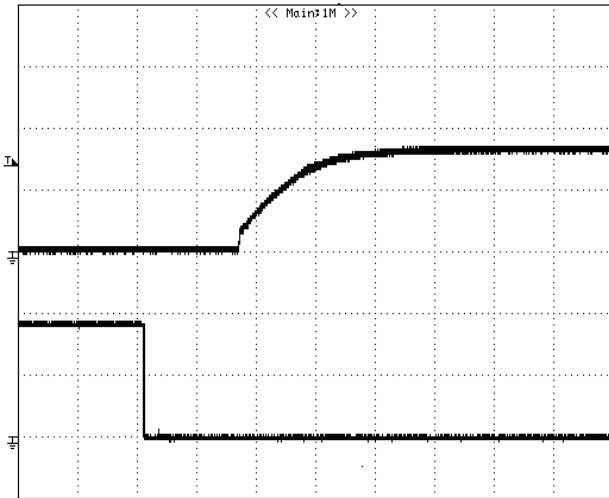

Figure 4: Turn-on transient at zero load current (5 ms/div). Vin=48V. Top Trace: Vout, 2V/div; Bottom Trace: ON/OFF input, 2V/div

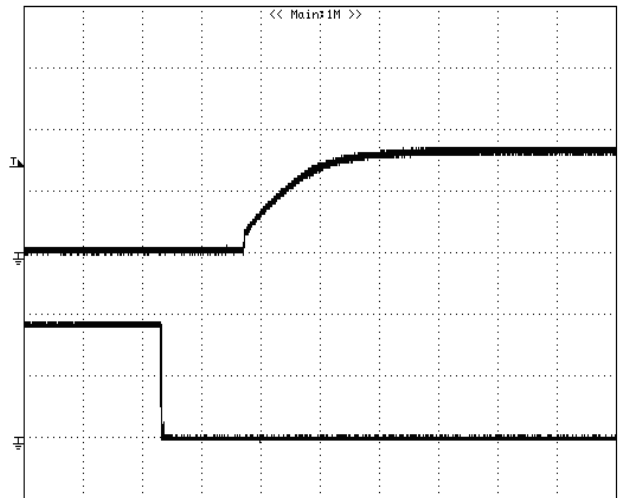

Figure 5: Turn-on transient at full rated load current (constant current load) (5 ms/div). Vin=48V. Top Trace: Vout, 2V/div; Bottom Trace: ON/OFF input, 2V/div

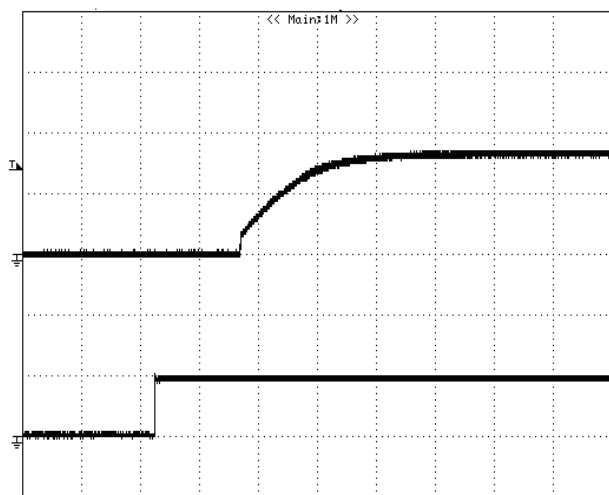

Figure 6: Turn-on transient at zero load current (5 ms/div). Vin=48V. Top Trace: Vout, 2V/div, Bottom Trace: input voltage, 50V/div

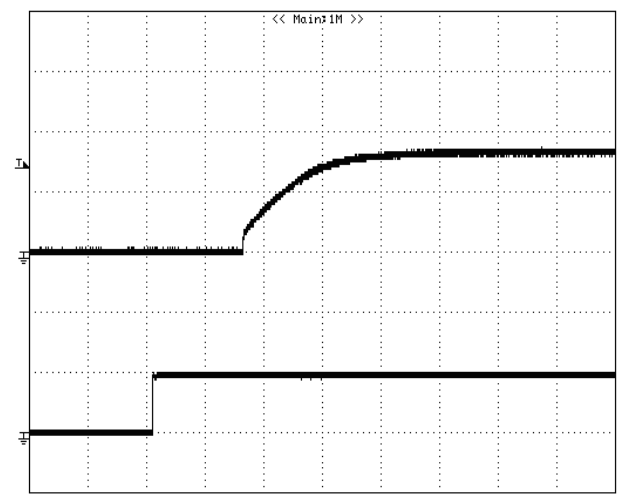

Figure 7: Turn-on transient at full rated load current (constant current load) (5 ms/div). Vin=48V. Top Trace: Vout, 2V/div; Bottom Trace: input voltage, 50V/div

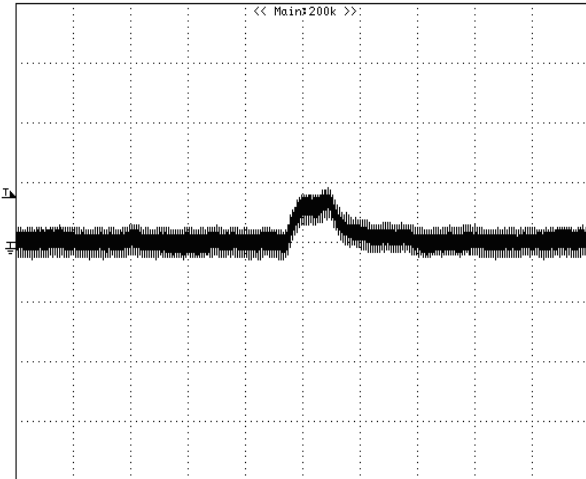

Figure 8: Output voltage response to step-change in load current (75%-50% of I_o , max; $di/dt = 0.1A/\mu s$). Load cap: $10\mu F$, tantalum capacitor and $1\mu F$ ceramic capacitor. Trace: V_{out} (50mV/div, 100us/div), Scope measurement should be made using a BNC cable (length shorter than 20 inches). Position the load between 51 mm to 76 mm (2 inches to 3 inches) from the module.

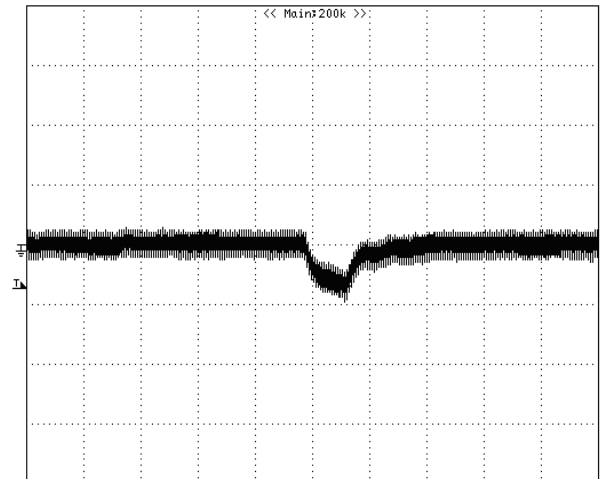

Figure 9: Output voltage response to step-change in load current (50%-75% of I_o , max; $di/dt = 0.1A/\mu s$). Load cap: $10\mu F$, tantalum capacitor and $1\mu F$ ceramic capacitor. Trace: V_{out} (50mV/div, 100us/div), Scope measurement should be made using a BNC cable (length shorter than 20 inches). Position the load between 51 mm to 76 mm (2 inches to 3 inches) from the module.

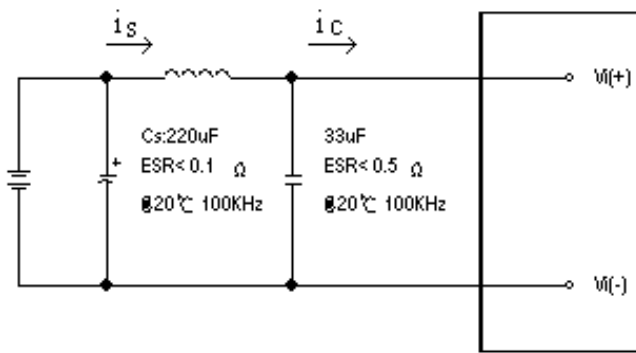

Figure 10: Test set-up diagram showing measurement points for Input Terminal Ripple Current and Input Reflected Ripple Current.

Note: Measured input reflected-ripple current with a simulated source Inductance (LTEST) of $12\mu H$. Capacitor C_s offset possible battery impedance. Measure current as shown above.

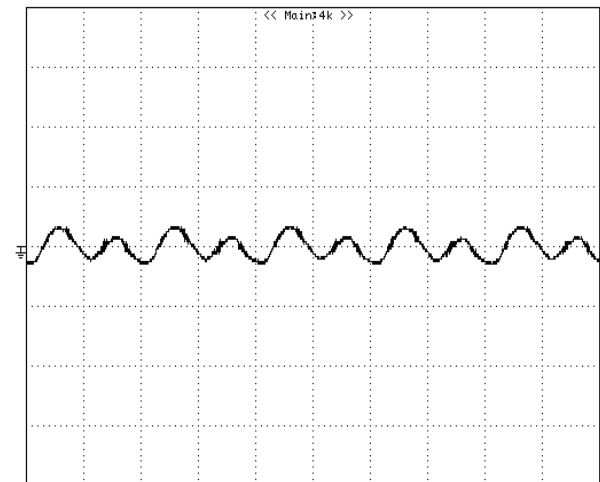

Figure 11: Input Terminal Ripple Current, i_c , at full rated output current and nominal input voltage with $12\mu H$ source impedance and $33\mu F$ electrolytic capacitor (200 mA/div, 2us/div).

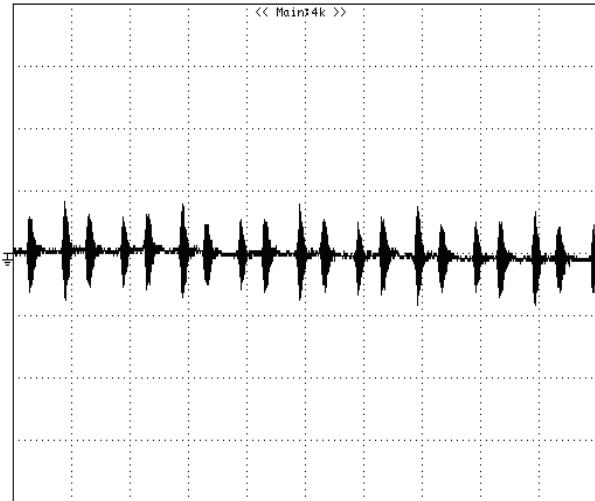

Figure 12: Input reflected ripple current, is, through a 12 μ H source inductor at nominal input voltage and rated load current (20 mA/div, 2 μ s/div).

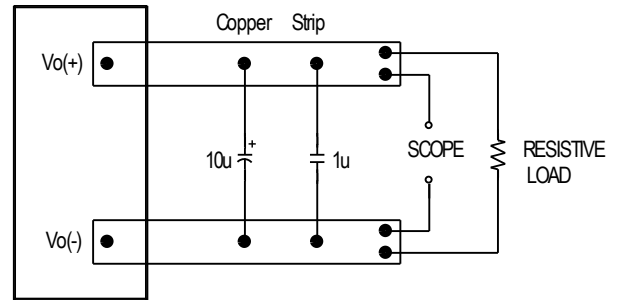

Figure 13: Output voltage noise and ripple measurement test setup

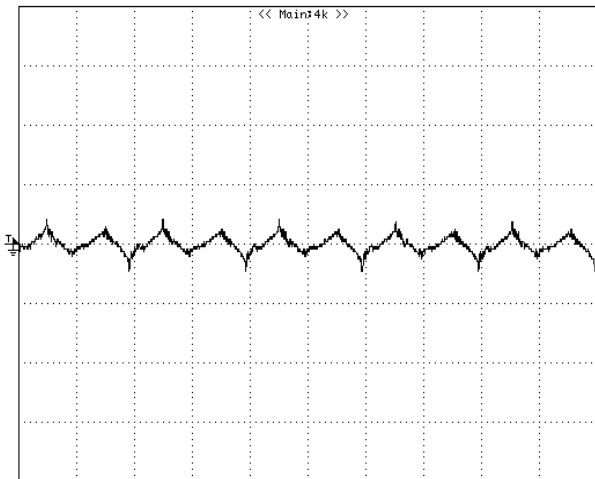

Figure 14: Output voltage ripple at nominal input voltage and rated load current ($I_o=30A$) (50 mV/div, 2 μ s/div)
Load capacitance: 1 μ F ceramic capacitor and 10 μ F tantalum capacitor. Bandwidth: 20 MHz. Scope measurements should be made using a BNC cable (length shorter than 20 inches). Position the load between 51 mm to 76 mm (2 inches to 3 inches) from the module.

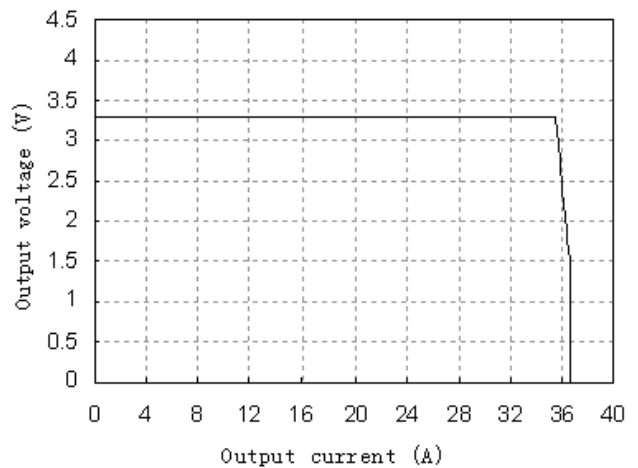

Figure 15: Output voltage vs. load current showing typical current limit curves and converter shutdown points.

Input Source Impedance

The impedance of the input source connecting to the DC/DC power modules will interact with the modules and affect the stability. A low ac-impedance input source is recommended. If the source inductance is more than a few μH , we advise adding a $10\mu\text{F}$ to $100\mu\text{F}$ electrolytic capacitor (ESR $< 0.7 \Omega$ at 100 kHz) mounted close to the input of the module to improve the stability.

Layout and EMC Considerations

Delta's DC/DC power modules are designed to operate in a wide variety of systems and applications. An external input filter module is available for easier EMC compliance design.

$C1=2.2\mu\text{F} \times 2\text{pcs} + 4.7\mu\text{F} \times 1\text{pcs}$, MLCC

$C2=C3=4.7\text{nF}$

$C4=100\mu\text{F} \times 2\text{pcs}$

$C5=3.9\text{nF} \times 2\text{pcs}$

$L1=0.08\text{mH}$, $L2=0.85\text{mH}$

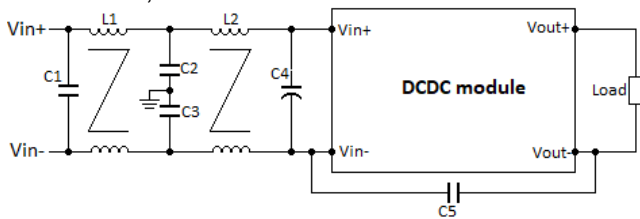

Test result:

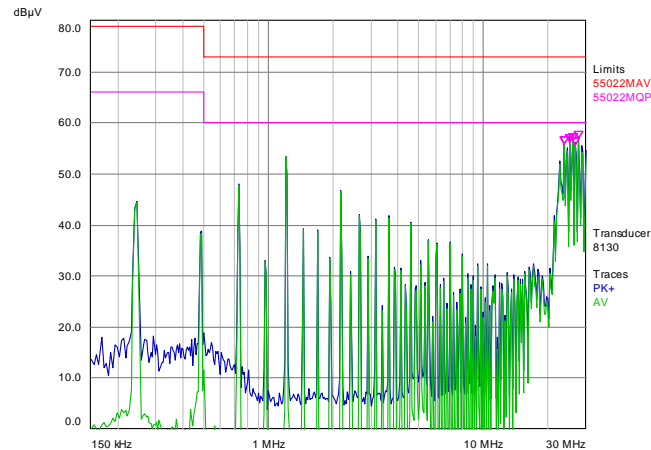

Safety Considerations

The power module must be installed in compliance with the spacing and separation requirements of the end-user's safety agency standard, i.e. IEC 62368-1: 2014 (2nd edition), EN 62368-1: 2014 (2nd edition), UL 62368-1, 2nd Edition, 2014-12-01 and CSA C22.2 No. 62368-1-14, 2nd Edition, 2014-12. IEC 60950-1: 2005, 2nd Edition + A1: 2009 + A2: 2013, EN 60950-1: 2006 + A11: 2009 + A1: 2010 + A12: 2011 + A2: 2013, UL 60950-1, 2nd Edition, 2011-10-14 and CSA C22.2 No. 60950-1-07, 2nd Edition, 2010-14, if the system in which the power module is to be used must meet safety agency requirements.

Basic insulation based on 75 Vdc input is provided between the input and output of the module for the purpose of applying insulation requirements when the input to this DC-to-DC converter is identified as TNV-2 or SELV. An additional evaluation is needed if the source is other than TNV-2 or SELV.

When the input source is SELV circuit, the power module meets SELV (safety extra-low voltage) requirements. If the input source is a hazardous voltage which is greater than 60 Vdc and less than or equal to 75 Vdc, for the module's output to meet SELV requirements, all of the following must be met:

- The input source must be insulated from the ac mains by reinforced or double insulation.
- The input terminals of the module are not operator accessible.
- A SELV reliability test is conducted on the system where the module is used, in combination with the module, to ensure that under a single fault, hazardous voltage does not appear at the module's output.

When installed into a Class II equipment (without grounding), spacing consideration should be given to the end-use installation, as the spacing between the module and mounting surface have not been evaluated.

The power module has extra-low voltage (ELV) outputs when all inputs are ELV.

This power module is not internally fused. To achieve optimum safety and system protection, an input line fuse is highly recommended. The safety agencies require a fast-blow fuse with 10A maximum rating to be installed in the ungrounded lead. A lower rated fuse can be used based on the maximum inrush transient energy and maximum input current.

Soldering and Cleaning Considerations

Post solder cleaning is usually the final board assembly process before the board or system undergoes electrical testing. Inadequate cleaning and/or drying may lower the reliability of a power module and severely affect the finished circuit board assembly test. Adequate cleaning and/or drying is especially important for un-encapsulated and/or open frame type power modules. For assistance on appropriate soldering and cleaning procedures, please contact Delta's technical support team.

Over-Current Protection

The E48SH modules include an internal output over-current protection circuit, which will endure current limiting for an unlimited duration during output overload. When the output current exceeds the OCP set point, the current limit function will work by initially reduce duty cycle of the module, the unit will go out of regulation but remains in safe operating area before the output drops below 50%. When output drops below 50%, the modules will automatically shut down and enter hiccup mode.

During hiccup, the modules will try to restart after shutdown. If the overload condition still exists, the module will shut down again. This restart trial will continue until the overload condition is corrected.

Over-Voltage Protection

The modules include an internal output over-voltage protection circuit, which monitors the voltage on the output terminals. If this voltage exceeds the over-voltage set point, the module will shut down and restart after 200mS. latch off mode is optional. Under latch off mode the over-voltage latch is reset by either cycling the input power or by toggling the on/off signal for one second.

Over-Temperature Protection

The over-temperature protection consists of circuitry that provides protection from thermal damage. If the temperature exceeds the over-temperature threshold the module will shut down.

The module will try to restart after shutdown. If the over-temperature condition still exists during restart, the module will shut down again. This restart trial will continue until the temperature is within specification.

Remote On/Off

The remote on/off feature on the module can be either negative or positive logic. Negative logic turns the module on during a logic low and off during a logic high. Positive logic turns the modules on during a logic high and off during a logic low.

Remote on/off can be controlled by an external switch between the on/off terminal and the Vi(-) terminal. The switch can be an open collector or open drain.

For negative logic if the remote on/off feature is not used, please short the on/off pin to Vi(-). For positive logic if the remote on/off feature is not used, please leave the on/off pin to floating.

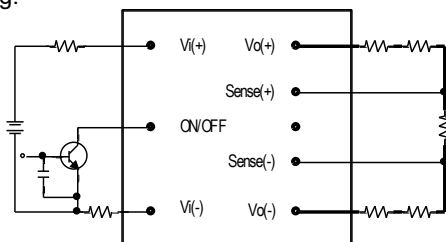

Figure 16: Remote on/off implementation

Remote Sense

Remote sense compensates for voltage drops on the output by sensing the actual output voltage at the point of load. The voltage between the remote sense pins and the output terminals must not exceed the output voltage sense range given here:

$$[Vo(+) - Vo(-)] - [SENSE(+) - SENSE(-)] \leq 10\% \times V_{out}$$

This limit includes any increase in voltage due to remote sense compensation and output voltage set point adjustment (trim).

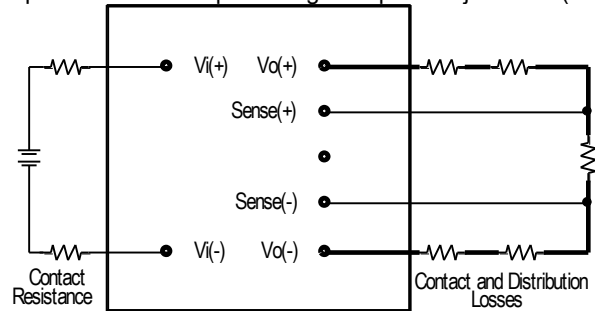

Figure 17: Effective circuit configuration for remote sense operation

If the remote sense feature is not used to regulate the output at the point of load, please connect SENSE(+) to Vo(+) and SENSE(-) to Vo(-) at the module.

The output voltage can be increased by both the remote sense and the trim; however, the maximum increase is the larger of either the remote sense or the trim, not the sum of both.

When using remote sense and trim, the output voltage of the module is usually increased, which increases the power output of the module with the same output current.

Care should be taken to ensure that the maximum output power does not exceed the maximum rated power.

Output Voltage Adjustment (TRIM)

To increase or decrease the output voltage set point, the modules may be connected with an external resistor between the TRIM pin and either the SENSE(+) or SENSE(-). The TRIM pin should be left open if this feature is not used.

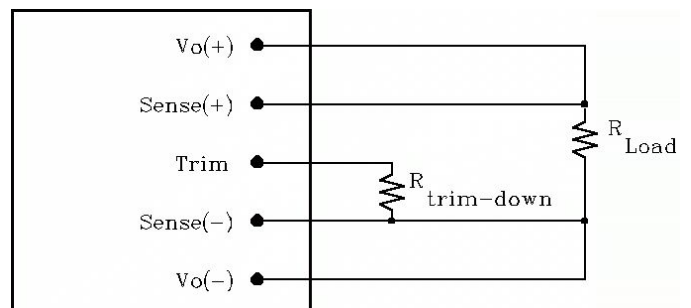

Figure 18: Circuit configuration for trim-down (decrease output voltage)

If the external resistor is connected between the TRIM and SENSE (-) pins, the output voltage set point decreases (Fig. 18). The external resistor value required to obtain a percentage of output voltage change $\Delta\%$ is defined as:

$$R_{trim-down} = \frac{511}{\Delta} - 10.2(K\Omega)$$

Ex. When Trim-down -10%(3.3V×0.9=2.97V)

$$R_{trim-down} = \frac{511}{10} - 10.2 = 40.9(K\Omega)$$

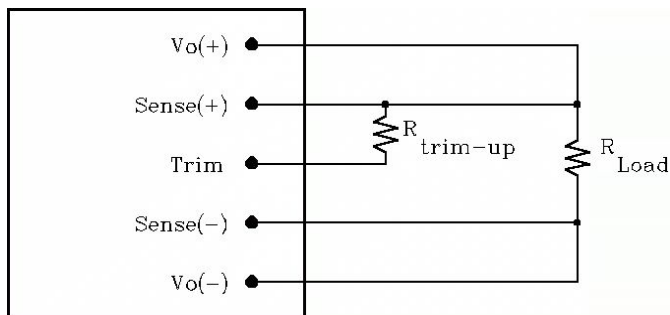

Figure 19: Circuit configuration for trim-up (increase output voltage)

If the external resistor is connected between the TRIM and SENSE (+) the output voltage set point increases (Fig. 19). The external resistor value required to obtain a percentage output voltage change $\Delta\%$ is defined as:

$$R_{trim-up} = \frac{5.11V_o(100 + \Delta)}{1.225\Delta} - \frac{511}{\Delta} - 10.2(K\Omega)$$

Ex. When Trim-up +10%(3V×1.1=3.3V)

$$R_{trim-up} = \frac{5.11 \times 3.3 \times (100 + 10)}{1.225 \times 10} - \frac{511}{10} - 10.2 = 90.1(K\Omega)$$

The output voltage can be increased by both the remote sense and the trim, however the maximum increase is the larger of either the remote sense or the trim, not the sum of both.

When using remote sense and trim, the output voltage of the module is usually increased, which increases the power output of the module with the same output current.

Care should be taken to ensure that the maximum output power of the module remains at or below the maximum rated power.

Frequency Synchronization

This product family can be synchronized with external clock signal to the TRIM pin. This reduces system noise and interference in multiple converter systems.

Thermal Management

Thermal management is an important part of the system design. To ensure proper, reliable operation, sufficient cooling of the power module is needed over the entire temperature range of the module. Convection cooling is usually the dominant mode of heat transfer.

Hence, the choice of equipment to characterize the thermal performance of the power module is a wind tunnel.

Thermal Testing Setup

Delta's DC/DC power modules are characterized in heated vertical wind tunnels that simulate the thermal environments encountered in most electronics equipment. This type of equipment commonly uses vertically mounted circuit cards in cabinet racks in which the power modules are mounted.

The following figure shows the wind tunnel characterization setup. The power module is mounted on a test PWB and is vertically positioned within the wind tunnel. The space between the neighboring PWB is constantly kept at 6.35mm (0.25").

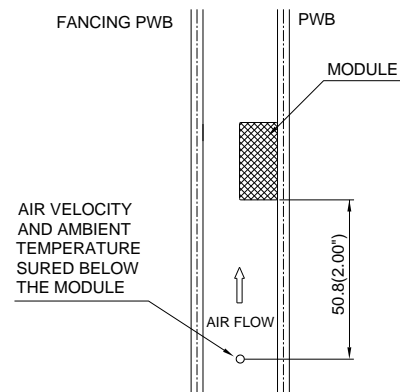

Note: Wind Tunnel Test Setup Figure Dimensions are in millimeters and (Inches)

Figure 20: Wind tunnel test setup

Thermal Derating

Heat can be removed by increasing airflow over the module. To enhance system reliability; the power module should always be operated below the maximum operating temperature. If the temperature exceeds the maximum module temperature, reliability of the unit may be affected.

Thermal Curves (Without Heat-Spreader)

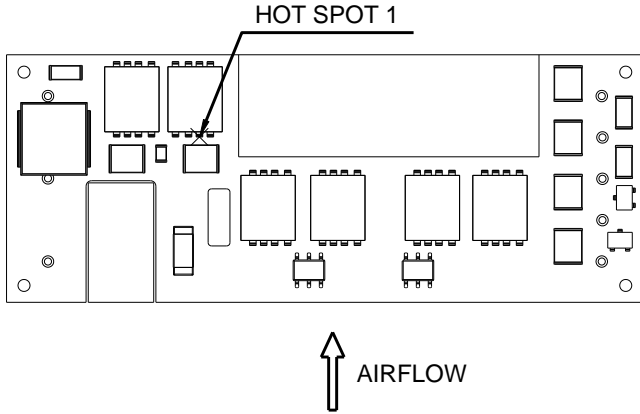

Figure 21: * Hot spot 1 & NTC resistor temperature measured points. The allowed maximum hot spot 1 temperature is defined at 124°C

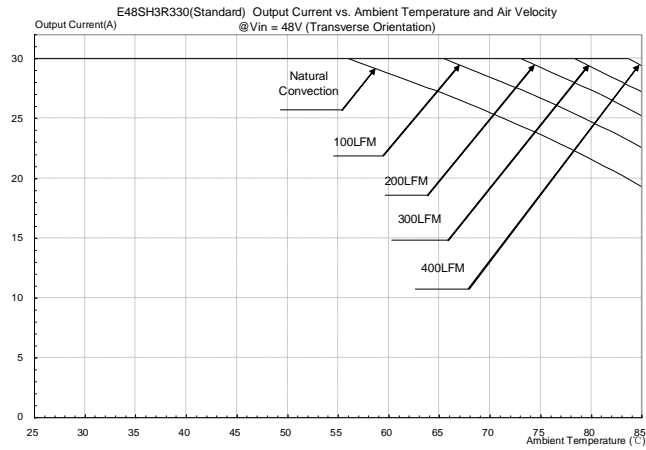

Figure 22: Output current vs. ambient temperature and air velocity Vin+, without heat spreader)

Thermal Curves (With Heat-Spreader)

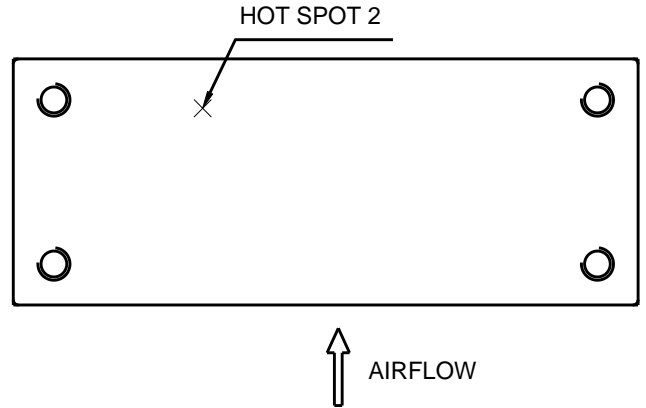

Figure 23: * Hot spot 2 temperature measured point. The allowed maximum hot spot 2 temperature is defined at 114°C

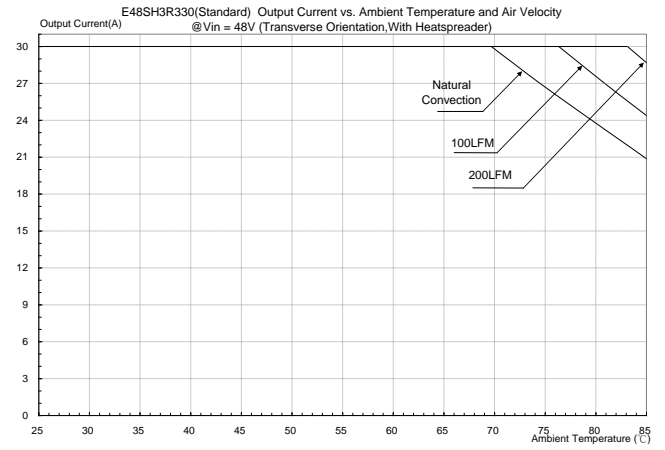
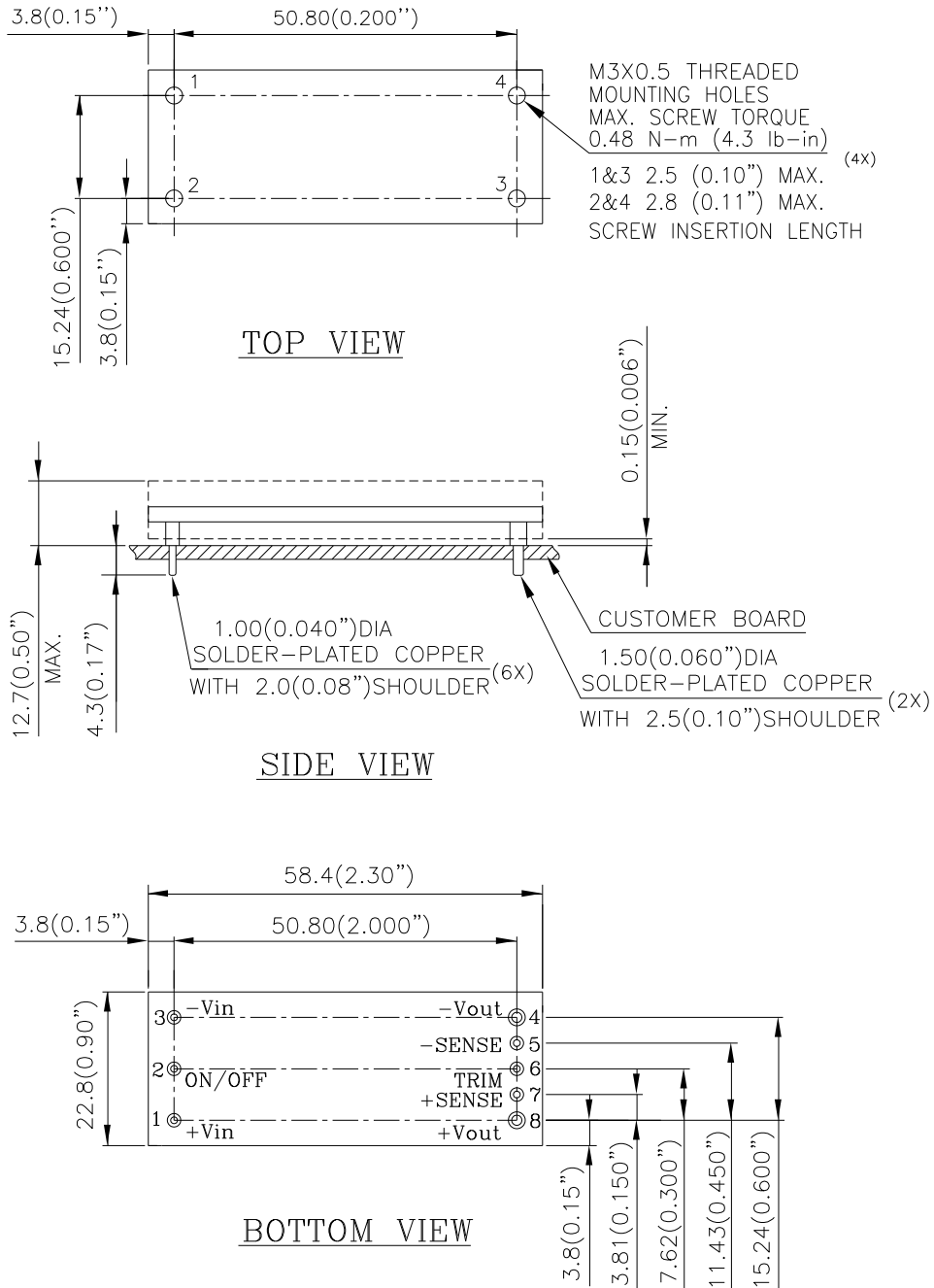

Figure 24: Output current vs. ambient temperature and air velocity Vin+, with heat spreader)

Mechanical Drawing (With Heat-Spreader)

THROUGH-HOLE MODULE



NOTES:
 DIMENSIONS ARE IN MILLIMETERS AND (INCHES)
 TOLERANCES: X.Xmm±0.5mm(X.XX in.±0.02 in.)
 X.XXmm±0.25mm(X.XXX in.±0.010 in.)

Mechanical Drawing (Without Heat-Spreader)

SURFACE-MOUNT MODULE

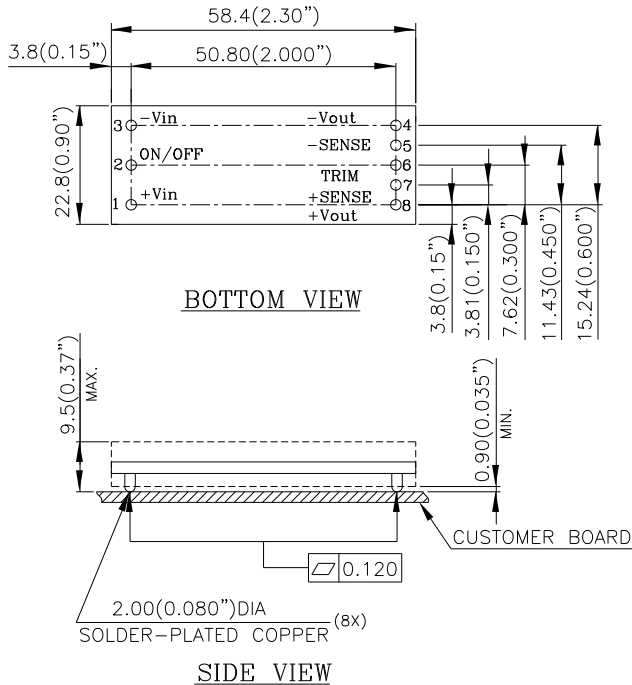

THROUGH-HOLE MODULE

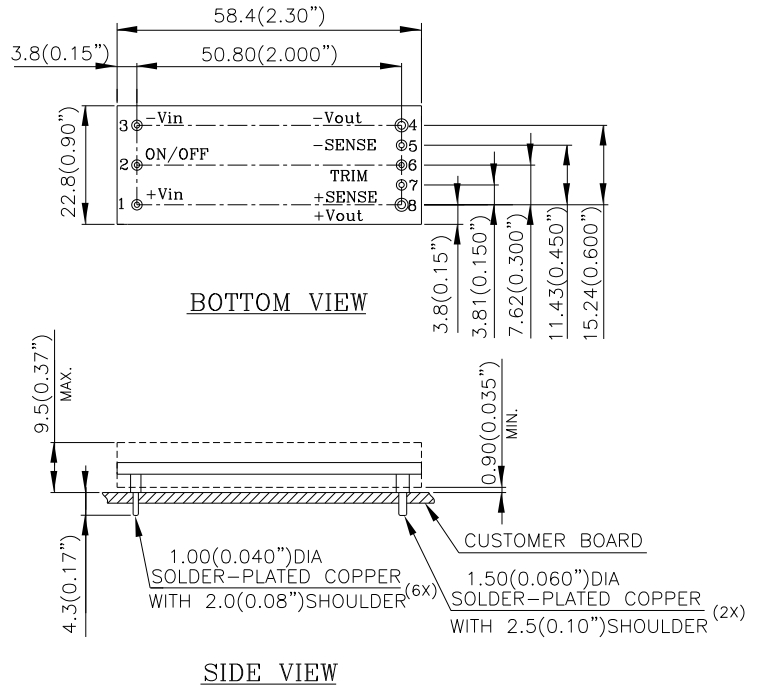

NOTES:
 DIMENSIONS ARE IN MILLIMETERS AND (INCHES)
 TOLERANCES: X.Xmm±0.5mm(X.XX in.±0.02 in.)
 X.XXmm±0.25mm(X.XXX in.±0.010 in.)

<u>Pin No.</u>	<u>Name</u>	<u>Function</u>
1	+Vin	Positive input voltage
2	ON/OFF	Remote ON/OFF
3	-Vin	Negative input voltage
4	-Vout	Negative output voltage
5	-SENSE	Negative remote sense
6	TRIM	Output voltage trim
7	+SENSE	Positive remote sense
8	+Vout	Positive output voltage

Pin Specification:

Pins 1-3,5-7 1.00mm (0.040") diameter
 Pins 4 & 8 1.50mm (0.059") diameter
 Note: All pins are copper alloy with matte-tin (Pb free) plated over Nickel underplating.

Recommended Pad Layout (For Through-Hole Module)

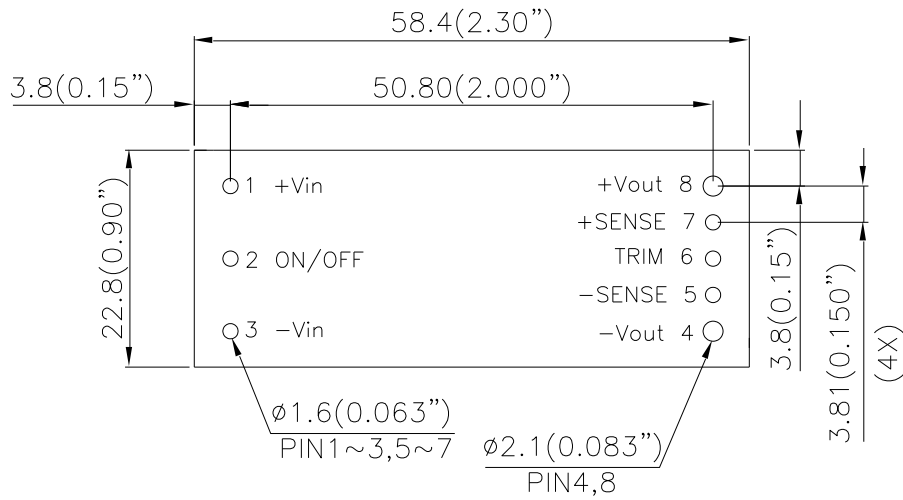

RECOMENDED P.W.B. PAD LAYOUT

NOTES:

DIMENSIONS ARE IN MILLIMETERS AND (INCHES)
 TOLERANCES: X.Xmm \pm 0.5mm(X.XX in. \pm 0.02 in.)
 X.XXmm \pm 0.25mm(X.XXX in. \pm 0.010 in.)

Recommended Pad Layout (for SMD Module)

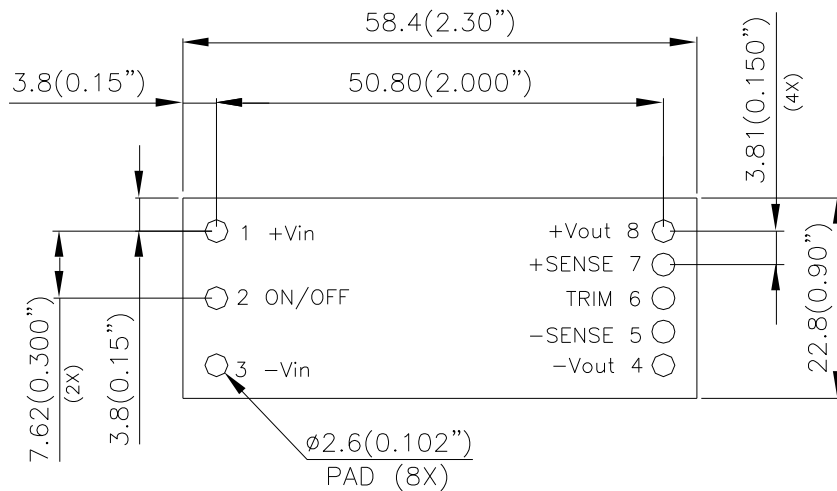

RECOMENDED P.W.B. PAD LAYOUT

NOTES:

DIMENSIONS ARE IN MILLIMETERS AND (INCHES)
 TOLERANCES: X.Xmm \pm 0.5mm(X.XX in. \pm 0.02 in.)
 X.XXmm \pm 0.25mm(X.XXX in. \pm 0.010 in.)

Pick & Place Location (For SMD Module Only)

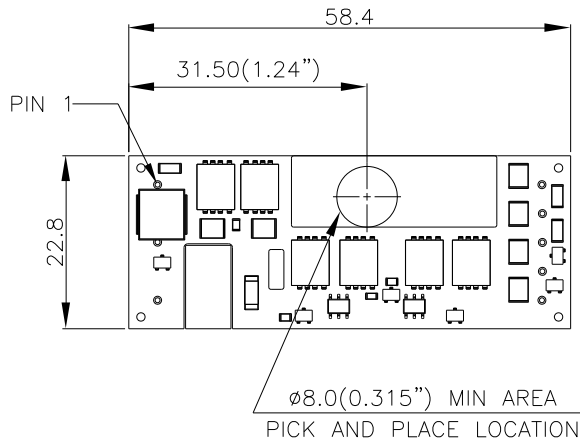

NOTES:

DIMENSIONS ARE IN MILLIMETERS AND (INCHES)

TOLERANCES: X.Xmm±0.5mm(X.XX in.±0.02 in.)

X.XXmm±0.25mm(X.XXX in.±0.010 in.)

Tape & Reel Package (For SMD Module Only)

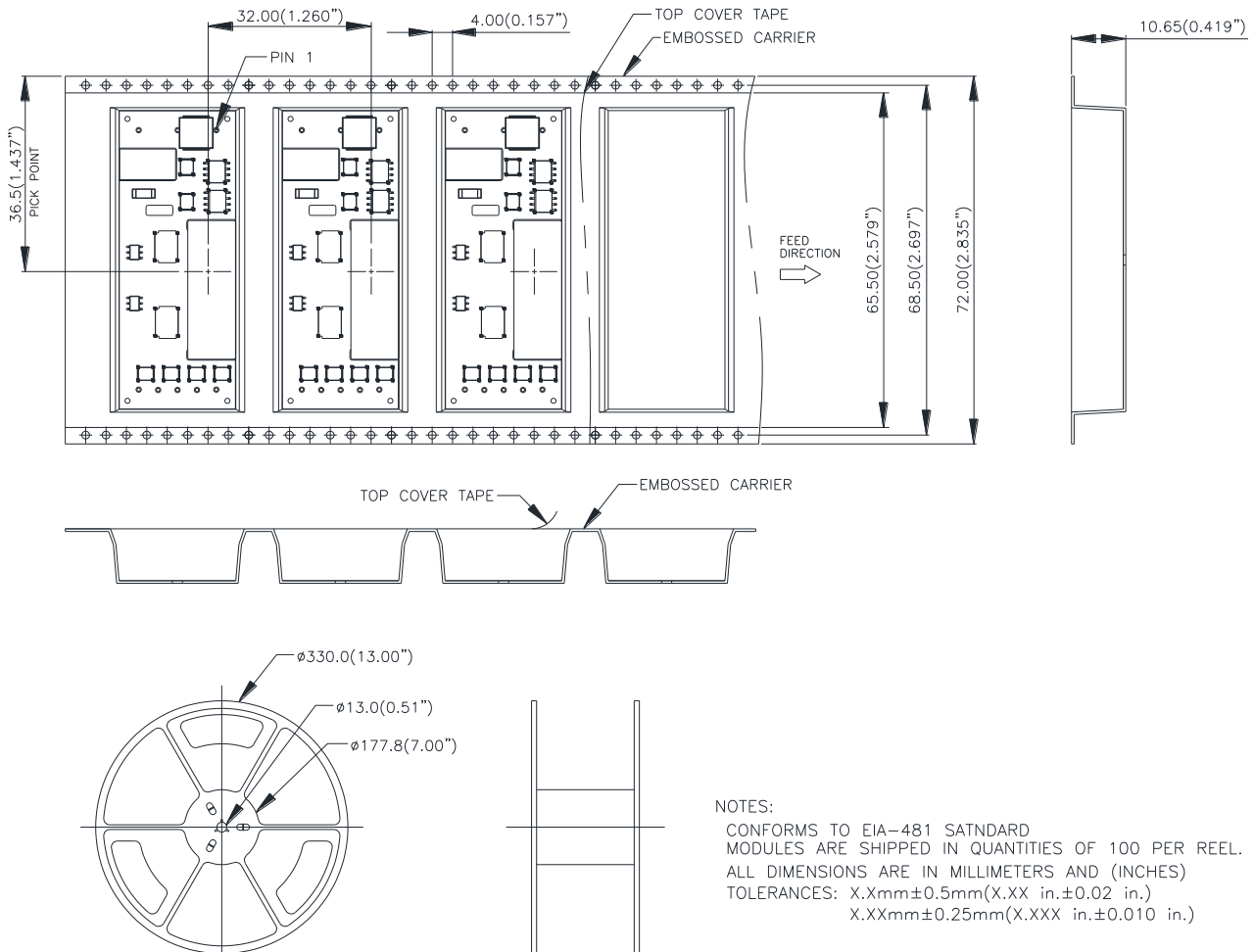

NOTES:

CONFORMS TO EIA-481 SATNDARD

MODULES ARE SHIPPED IN QUANTITIES OF 100 PER REEL.

ALL DIMENSIONS ARE IN MILLIMETERS AND (INCHES)

TOLERANCES: X.Xmm±0.5mm(X.XX in.±0.02 in.)

X.XXmm±0.25mm(X.XXX in.±0.010 in.)

Soldering Method

Generally, as the most common mass soldering method for the solder attachment, wave soldering is used for through-hole power modules and reflow soldering is used for surface-mount ones. Delta recommended soldering methods and process parameters are provided in this document for solder attachment of power modules onto system board. SAC305 is the suggested lead-free solder alloy for all soldering methods. The soldering temperature profile presented in this document is based on SAC305 solder alloy.

Wave Soldering (Lead-free)

Delta's power modules are designed to be compatible with single-wave or dual wave soldering. The suggested soldering process must keep the power module's internal temperature below the critical temperature of 217°C continuously. The recommended wave-soldering profile is shown below:

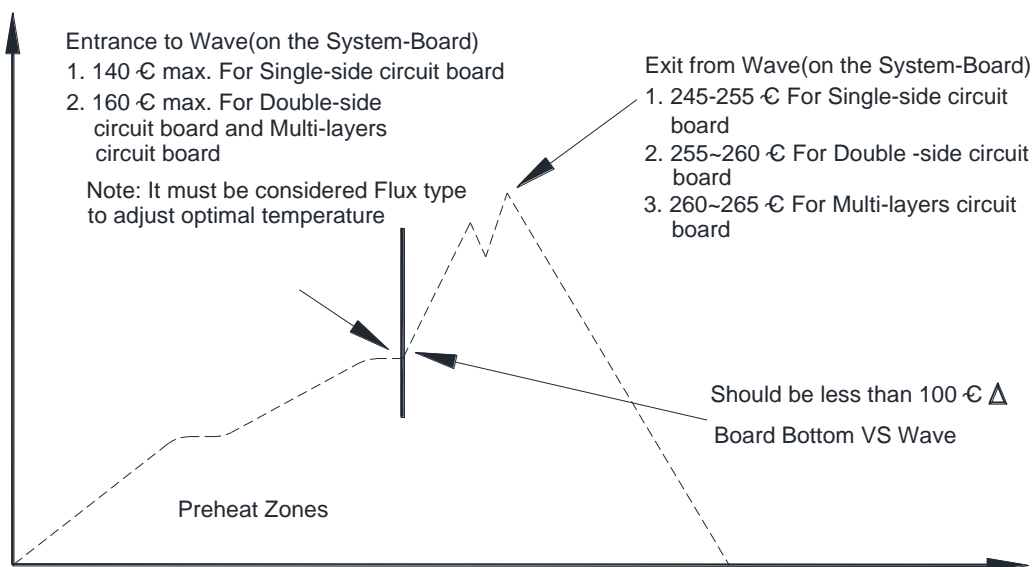

Note: The temperature is measured on solder joint of pins of power module.

The typical recommended (for double-side circuit board) preheat temperature is 115+/-10°C on the top side (component side) of the circuit board. The circuit-board bottom-side preheat temperature is typically recommended to be greater than 135°C and preferably within 100°C of the solder-wave temperature. A maximum recommended preheat up rate is 3°C /s. A maximum recommended solder pot temperature is 255+/-5°C with solder-wave dwell time of 3~6 seconds. The cooling down rate is typically recommended to be 6°C/s maximum.

Reflow Soldering (Lead-free)

High temperature and long soldering time will result in IMC layer increasing in thickness and thereby shorten the solder joint lifetime. Therefore, the peak temperature over 245°C is not suggested due to the potential reliability risk of components under continuous high-temperature. In the meanwhile, the soldering time of temperature above 217°C should be less than 60 seconds, and the cooling down rate should be less than 2°C/minutes. Please refer to following fig for recommended temperature profile parameters.

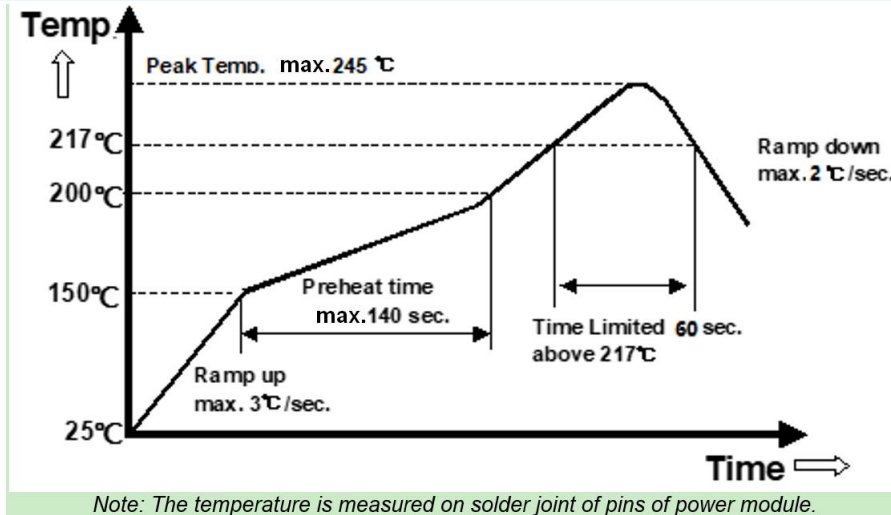

The module's top side Q2/Q4/Q101/Q102/Q103/Q104/Q508/L2 that under heat-spreader are critical components, customer must make sure these components solder joint temperature below 210 °C when customer reflow solder the model to customer system board.

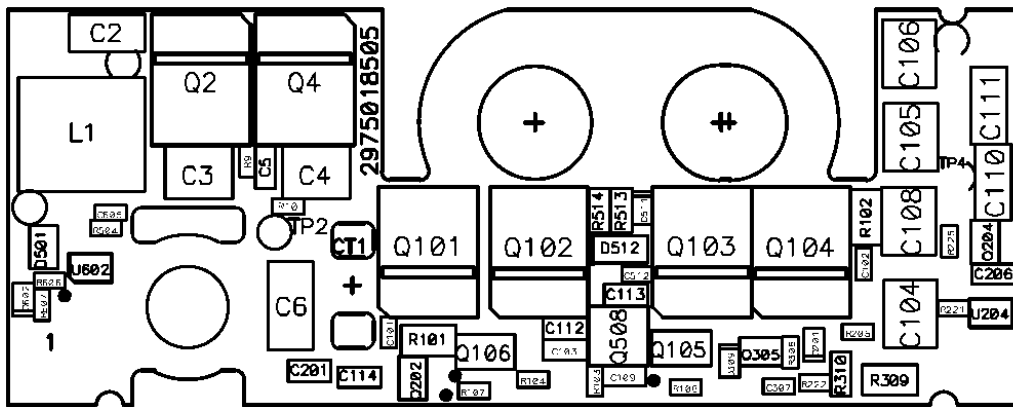

Hand Soldering (Lead Free)

Hand soldering is the least preferred method because the amount of solder applied, the time the soldering iron is held on the joint, the temperature of the iron, and the temperature of the solder joint are variable. The recommended hand soldering guideline is listed in Table below. The suggested soldering process must keep the power module's internal temperature below the critical temperature of 217 °C continuously.

Parameter	Single-side Circuit Board	Double-side Circuit Board	Multi-layers Circuit Board
Soldering Iron Wattage	90	90	90
Tip Temperature	385 +/- 10 °C	420 +/- 10 °C	420 +/- 10 °C
Soldering Time	2 ~ 6 seconds	4 ~ 10 seconds	4 ~ 10 seconds

PART NUMBERING SYSTEM

E	48	S	H	3R3	30	N	R	F	A
Type of Product	Input Voltage	Number of Outputs	Product Series	Output Voltage	Output Current	ON/OFF Logic	Pin Length /Type		Option Code
E- Eighth Brick	48-36V~75V	S- Single	H- series number	3R3 - 3.3V	30 - 30A	N- Negative P- Positive	R- 0.170" N- 0.145" K- 0.110" M- SMD	F- RoHS (Lead Free)	A- Standard Functions H - With Heat-Spreader

RECOMMENDED PART NUMBER.

Model Name	Input	Output	Eff. @100% Load
E48SH3R330NRFA	36V~75V	3.6A 3.3V 30A	92%
E48SH3R330NRFH	36V~75V	3.6A 3.3V 30A	92%

Please contact with Delta sales/FAE for different optional functions.

CONTACT US:

Website: www.deltaww.com/dcdc

Email: dcdc@deltaww.com

USA:

Telephone:
East Coast: 978-656-3993
West Coast: 510-668-5100
Fax: 510-668-0680

Europe:

Telephone: +31-20-800-3900
Fax: +31-20-800-3999

Asia & the rest of world:

Telephone: +886-3-452-6107
Ext. 6221~6226
Fax: +886-3-433-1810



WARRANTY

Delta offers a two (2) year limited warranty. Complete warranty information is listed on our web site or is available upon request from Delta.

Information furnished by Delta is believed to be accurate and reliable. However, no responsibility is assumed by Delta for its use, nor for any infringements of patents or other rights of third parties, which may result from its use. No license is granted by implication or otherwise under any patent or patent rights of Delta. Delta reserves the right to revise these specifications at any time, without notice.

Looking for pricing, stock, or lifecycle information?

Click below to explore more details on WIN SOURCE:

-  [View E48SH3R330NRFA on WIN SOURCE](#)
-  [Delta Electronics Information](#)

Optimize Your Supply Chain with WIN SOURCE Solutions

-  Global Sourcing Solution
-  Obsolete Management
-  Cost Control Management
-  Shortage Management
-  Alternative Solution
-  Excess Inventory Management