



**THE DATASHEET OF  
QLS25ZE-NT**



# QLS25 Series

## Quarter-Brick DC-DC Converter

The QLS25 is a series of cost-effective, high-density single output DC-DC converters providing on-board conversion of standard telecom and datacom input voltages into isolated low voltage outputs in a through-hole mounting package. High efficiencies and a patent-pending board design significantly improve thermal characteristics by evening out hot spots and enhance product reliability.

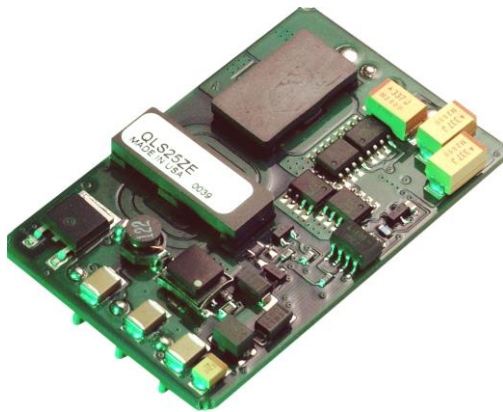

### Key Features & Benefits

- RoHS lead solder exemption compliant
- Cost-effective single board design
- Low profile – 11 mm height
- Input/output isolation: 1500 VDC, basic insulation
- High efficiency - up to 90% at full load
- Start-up into high capacitive load
- Low conducted and radiated EMI
- Output overcurrent protection
- Output overvoltage protection
- Back drive protection
- Overtemperature protection
- Remote sense
- Set point accuracy  $\pm 1\%$
- Remote on/off (primary referenced), positive or negative logic
- Output voltage trim adjust, positive or negative
- Approved to the latest edition of the following standards: UL/CSA60950-1, IEC60950-1 and EN60950-1.

### Applications

- Distributed power architectures
- Telecommunications equipment
- LAN/WAN applications
- Data processing applications

# QLS25 Series

## 1. MODEL SELECTION

MODEL	INPUT VOLTAGE VDC	INPUT CURRENT, MAX ADC	OUTPUT VOLTAGE VOUT, VDC	OUTPUT RATED CURRENT I <sub>RATED</sub> , ADC	OUTPUT RIPPLE/NOISE, MV P-P	TYPICAL EFFICIENCY @ I <sub>RATED</sub> , %
QLS20ZG	36-75	4.8	5.0	20	150	90
QLS25ZE	36-75	3.3	3.3	25	100	89
QLS25ZD	36-75	2.5	2.5	25	100	87

This product is intended for integration into end-use equipment. All the required procedures for CE marking of end-use equipment should be followed.

Model numbers highlighted in yellow or shaded are not recommended for new designs.

## 2. ELECTRICAL SPECIFICATIONS

All specifications apply over specified input voltage, output load, and temperature range, unless otherwise noted.

PARAMETER	CONDITIONS / DESCRIPTION	MIN	NOM	MAX	UNITS
<b>Absolute Maximum Ratings<sup>1</sup></b>					
Input Voltage	Continuous			75	VDC
	Transient, 100ms			100	VDC
Operating Temperature	PC Board Temperature	-40		100	°C
Storage Temperature		-40		125	°C
ON/OFF Control Voltage	Referenced to -Vin			50	VDC
<b>Isolation Characteristics</b>					
Insulation Safety Rating			Basic		
Isolation Voltage		1500			VDC
Isolation Resistance		10			MΩ
Isolation Capacitance		1100			pF
<b>Feature Characteristics</b>					
Shutdown (ON/OFF) Negative Logic	On/Off signal is low – converter is ON				
Converter ON		-1.0		1.8	VDC
Source Current	ON/OFF pin is connected to -Vin			1	mADC
Converter OFF		3.5		50	VDC
Open Circuit Voltage	ON/OFF pin is floating			5	VDC
Shutdown (ON/OFF) Positive Logic	On/Off signal is low –converter is OFF				
Converter ON		3.5		50	VDC
Open Circuit Voltage	ON/OFF pin is floating			5	VDC
Converter OFF		-1		1.8	VDC
Source Current	ON/OFF pin is connected to -Vin			1	mADC
Overtemperature Protection	Average Board Temperature		105		°C
<b>Input Characteristics</b>					
Operating Input Voltage Range	Continuous	36	48	75	VDC
Turn-On Input Voltage	Ramping Up		33		VDC
Turn-Off Input Voltage	Ramping Down		32		VDC

# QLS25 Series

Turn-On Time	To Output Regulation Band 100% Resistive Load	5	10	ms
Input Reflected Ripple Current	Full Load, 12 $\mu$ H source inductance		60	mA p-p
Inrush Transient	Vin=Vin.max		0.1	A <sup>2</sup> s
<b>Output Characteristics</b>				
Output Voltage Setpoint Accuracy	Vin=Vin.nom, Full Load	-1	1	%Vout
Output Current Range <sup>2</sup>	See selection chart for I <sub>rated</sub>	10	100	%I <sub>rated</sub>
Line Regulation	Vin.min to Vin.max, I <sub>rated</sub>		0.2	%Vout
Load Regulation	Vin=Vin.nom, 10% to 100%I <sub>rated</sub>		0.2	%Vout
Total output voltage regulation	Over all input voltage, load, and temperature conditions	-2	2	%Vout
Remote Sense Headroom			0.5	VDC
Dynamic Regulation	50-75% load step change			
Peak Deviation			5	%Vout
Settling Time	to 1% error band		150	$\mu$ s
Admissible Load Capacitance	I <sub>rated</sub> , Nom Vin	20,000		$\mu$ F
Output Current Limit Threshold <sup>3</sup>	Vout $\leq$ 0.97Vout.nom	110	140	%I <sub>rated</sub>
Switching Frequency		270		kHz
Overvoltage Protection, Non Latching	Overall input voltage and load conditions	120	140	%Vout
Trim Range	I <sub>rated</sub> , Vin=Vnom	90	110	%Vout
<b>Environmental and Mechanical</b>				
Weight		1.2/35		Oz/g
Sinusoidal Vibration	GR-63-Core, Section 5.4.2	1		g
Shock	Halfsine wave, 3 axes	50		g
Water Washing	Standard process		Yes	
<b>Reliability</b>				
MTBF	Per Bellcore TR-NWT-000332	1,980		kHrs

<sup>1</sup> Stresses in excess of the absolute maximum ratings may cause performance degradation, adversely effect long-term reliability, and cause permanent damage to the converter

<sup>2</sup> At I<sub>out</sub><I<sub>out.min</sub>, the output may contain low frequency component that exceeds ripple specifications.

<sup>3</sup> Overcurrent protection is non-latching with auto recovery.

# QLS25 Series

## 3. OPERATIONS

### 2.1 TYPICAL APPLICATION

Figure 1 shows the recommended connections for the QLS25 Series converter.

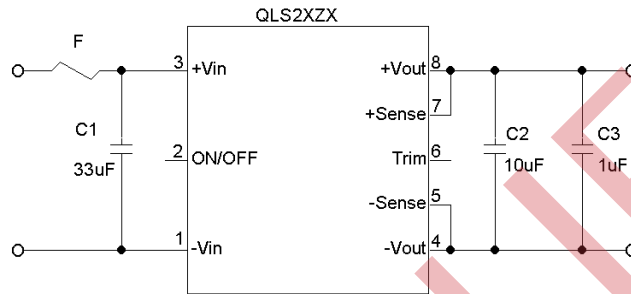

Figure 1. Typical Application of QLS25 Series

The QLS25 Series converters do not require any external components for proper operation. However, if the distribution of the input voltage to the converter contains significant inductance, the capacitor C1 may be required to enhance performance of the converter. A minimum of a 33µF electrolytic capacitor with the ESR<0.7Ω is recommended for the QLS25 Series.

Refer to the “Inrush Current Control Application Note” on [belpowersolutions.com](http://belpowersolutions.com) for suggestions on how to limit the magnitude of the inrush current.

For output decoupling we recommend to use a 10µF tantalum and a 1µF ceramic capacitors connected directly across the output pins of the converter. Note, that the capacitors do not substitute the filtering required by the load.

### 2.2 SHUTDOWN FEATURE DESCRIPTION

The ON/OFF pin in the QLS25 Series converters functions as a normal soft shutdown. It is referenced to the -Vin pin (see Figure 1). With the positive logic, when the ON/OFF pin is pulled low, the output is turned off and the unit goes into a very low input power mode.

With negative logic, when the ON/OFF pin is pulled low, the unit is turned on.

An open collector switch is recommended to control the voltage between the ON/OFF pin and the -Vin pin of the converter. The ON/OFF pin is pulled up internally, so no external voltage source is required. The user should avoid connecting a resistor between the ON/OFF pin and the +Vin pin.

When the ON/OFF pin is used to achieve remote control, the user must take care to insure that the pin reference for the control is really the -Vin pin. The control signal must not be referenced ahead of EMI filtering, or remotely from the unit. Optically coupling the information and locating the optical coupler directly at the module will solve any of these problems.

**Note:**

If the ON/OFF pin is not used, it can be left floating (positive logic), or connected to the -Vin pin (negative logic).

### 2.3 OUTPUT VOLTAGE TRIM

The trim feature allows the user to adjust the output voltage from the nominal. This can be used to accommodate a different requirement or to do production margin testing. There are two variances available in the QLS25 Series.

# QLS25 Series

## 2.4 NEGATIVE TRIM

The QLS25 negative trim units trim up with a resistor from the TRIM pin to the –Sense pin and trim down with a resistor from the TRIM pin to the +Sense pin, as shown in Fig.2. The negative trim schematic is shown in Figure 2.

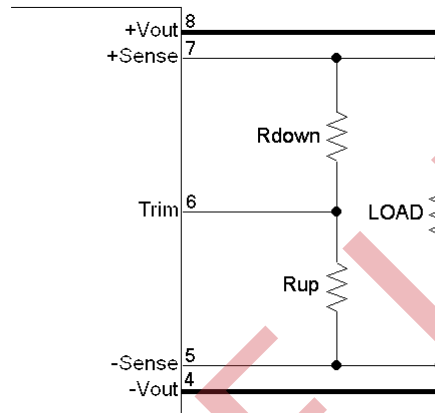

Figure 2. QLS25 Series Negative Trim Schematic

The general equation (1) for changing the output voltage on the negative trim modules is invariant, but the constants in the equation change due to different internal values.

$$R_{TRIM} = \frac{A - B \times \Delta V}{\Delta V}, \quad [\text{k}\Omega] \quad (1)$$

where,

A and B are constants from the table below, and  $\Delta V$  is the absolute value of the desired change in the output voltage in Volts.

MODEL	TRIM UP		TRIM DOWN	
	A	B	A	B
QLS20ZG	3.77	6.81	11.58	9.88
QLS25ZE	2.07	3.92	3.5	5.61
QLS25ZD	1.27	3.92	1.31	4.95

# QLS25 Series

## 2.5 POSITIVE TRIM (SUFFIX - T)

The -T option units trim up with a resistor from the TRIM pin to the +Sense pin and trim down with a resistor from the TRIM pin to the -Sense pin as shown in the Figure 3.

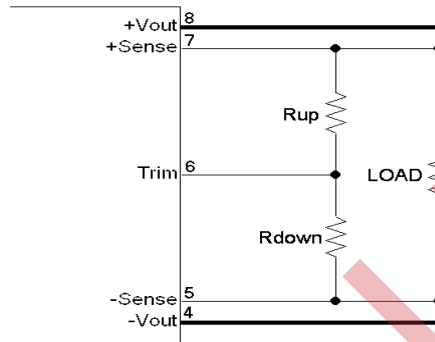

Figure 3. QLS25 Series Positive Trim Schematic

The equations below determine the trim resistor value required to achieve a  $\Delta V$  change in the output voltage.

$$R_{UP} = 5.11 \left( \frac{V_{out}(100 + \Delta V\%) - 100 + 2\Delta V\%}{1.225\Delta V\%} \right), \text{ k}\Omega$$

$$R_{DOWN} = 5.11 \left( \frac{100}{\Delta V\%} - 2 \right), \text{ k}\Omega$$

Where,

$\Delta V\%$  is the output voltage change expressed in percents of the nominal output voltage,  $V_{out}$ .

### Notes:

1. When the output voltage is trimmed up, the output power from the converter must not exceed its maximum rating. The power is determined by measuring the output voltage on the output pins, and multiplying it by the output current.
2. In order to avoid creating apparent load regulation degradation, it is important that the trim resistors are connected directly to the remote sense pins, and not to the load or to traces going to the load.
3. The QLS25 Series converters will trim down further than the 10% limit. In general, this is permissible. The user must confirm that the results are acceptable in the application.

# QLS25 Series

## 2.6 CHARACTERISTIC CURVES

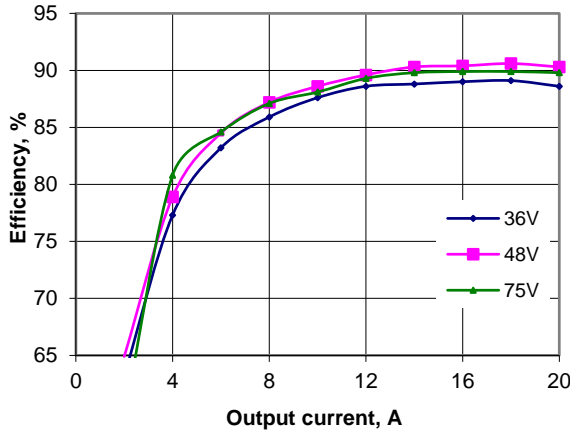

Figure 4. QLS20ZG Efficiency vs. Output Load

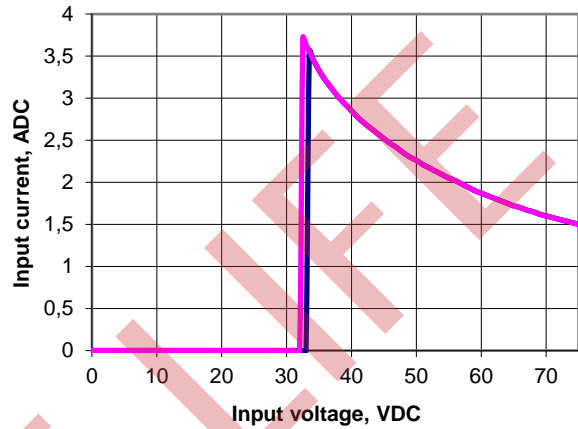

Figure 5. QLS20ZG Input Characteristic

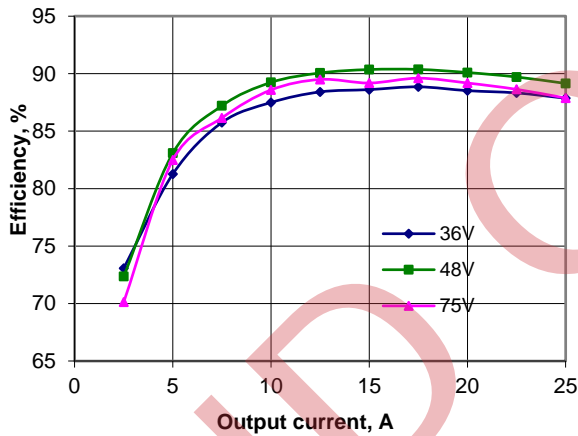

Figure 6. QLS25ZE Efficiency vs. Output Load

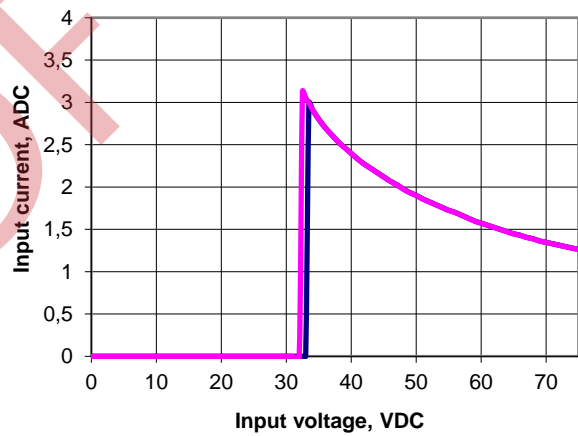

Figure 7. QLS25ZE Input Characteristic

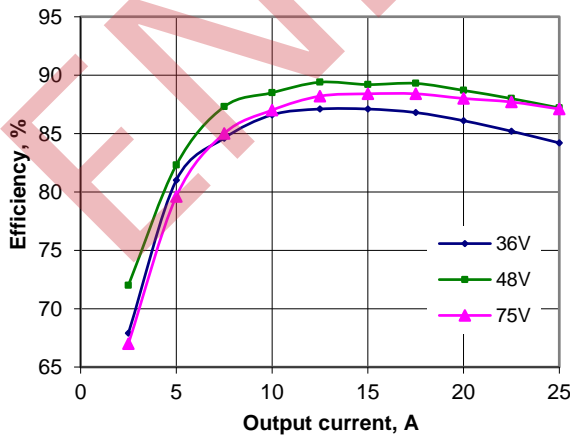

Figure 8. QLS25ZE Efficiency vs. Output Load

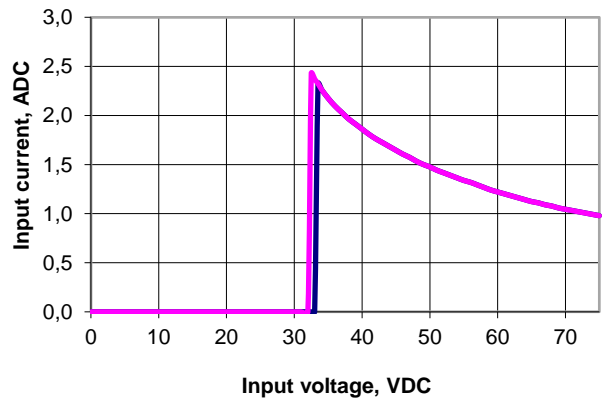

Figure 9. QLS25ZD Input Characteristic

# QLS25 Series

## 4. SAFETY CONSIDERATIONS

The QLS25 Series converters feature 1500 Volt DC isolation from input to output. The input to output resistance is greater than 10M $\Omega$ . These converters are provided with Basic insulation between input and output circuits according to all IEC60950 based standards. Nevertheless, if the system using the converter needs to receive safety agency approval, certain rules must be followed in the design of the system. In particular, all of the creepage and clearance requirements of the end-use safety requirements must be observed. These documents include UL60950 - CSA60950-00 and EN60950, although other or additional requirements may be needed for specific applications.

The QLS25 Series converters have no internal fuse. The external fuse must be provided to protect the system from catastrophic failure as shown in Figure 7. The fuse with a rating not greater than 4A is recommended. The user can select a lower rating fuse based upon the highest inrush transient at the maximum input voltage and the maximum input current of the converter, which occurs at the minimum input voltage. Both input traces and the chassis ground trace (if applicable) must be capable of conducting a current of 1.5 times the value of the fuse without opening. The fuse must not be placed in the grounded input line, if any.

In order for the output of the QLS25 Series converter to be considered as SELV (Safety Extra Low Voltage) or TNV-1, according to all IEC60950 based standards, one of the following requirements must be met in the system design:

- If the voltage source feeding the module is SELV or TNV-2, the output of the converter may be grounded or ungrounded.
- If the voltage source feeding the module is ELV, the output of the converter may be considered SELV only if the output is grounded per the requirements of the standard.
- If the voltage source feeding the module is a Hazardous Voltage Secondary Circuit, the voltage source feeding the module must be provided with at least Basic insulation between the source to the converter and any hazardous voltages. The entire system, including the QLS25 converter, must pass a dielectric withstand test for Reinforced insulation. Design of this type of systems requires expert engineering and understanding of the overall safety requirements and should be performed by qualified personnel.

## 5. THERMAL CONSIDERATIONS

The QLS25 Series converters are designed for natural or forced convection cooling. The maximum allowable output current of the converters is determined by meeting the derating criteria for all components used in the converters. For example, the maximum semiconductor junction temperature is not allowed to exceed 120°C to ensure reliable long-term operation of the converters. Contact Bel Power Solutions for the complete list of the derating criteria.

The graphs in Figures 10-12 show the maximum output current of the QLS25 Series converters at different ambient temperatures under both natural and forced (longitudinal airflow direction, from pin 1 to pin 3) convection.

For example, from Figure 11, the QLS25ZE operating at 55°C can deliver up to 18A reliably with 100LFM forced air, while up to 25A reliably with 400LFM forced air.

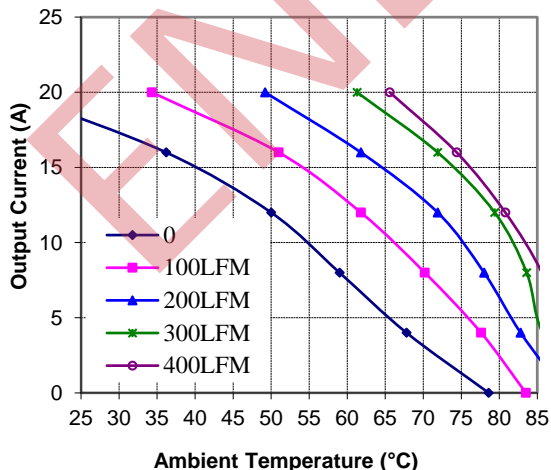

Figure 10. QLS20ZG (5V) Derating Curves

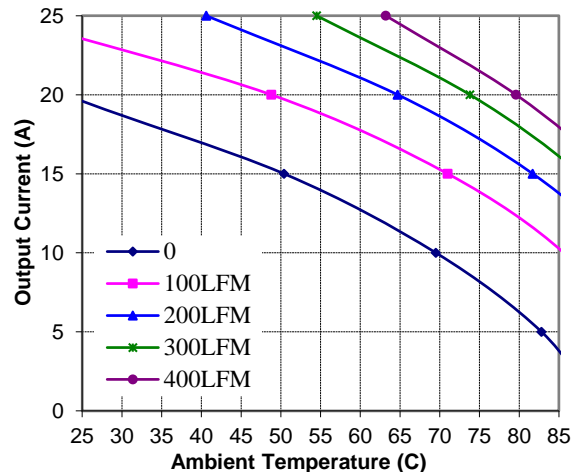

Figure 11. QLS25ZE (3.3V) Derating Curves

# QLS25 Series

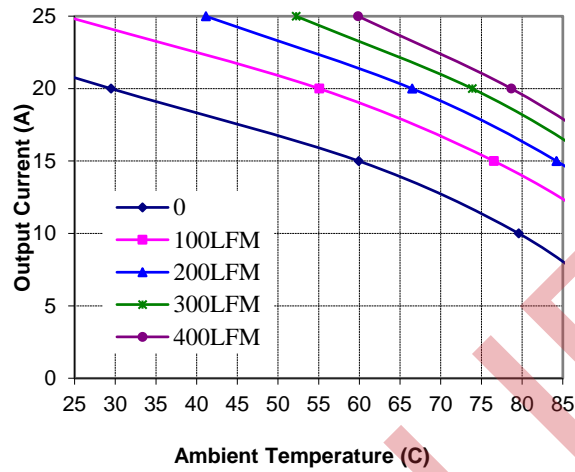
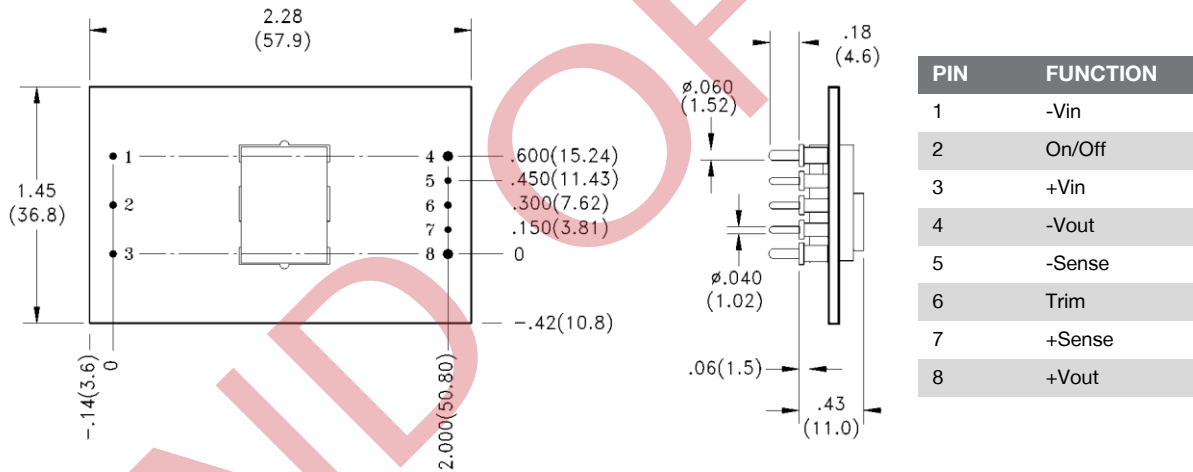

Figure 12. QLS25ZD (2.5V) Derating Curves

## 6. MECHANICAL PARAMETERS



Tolerances: .xx ± .020 (.5)  
 .xxx ± .010 (.25)  
 Pin Diameter ± 0.002 (.05)

# QLS25 Series

## 7. ORDERING INFORMATION

OPTIONS	SUFFIXES TO ADD TO PART NUMBER
Remote ON/OFF	Positive- Standard, no suffix required
	Negative- Add "N" suffix
Trim	Negative- no suffix required
	Positive - Add "T" suffix
Pin Length	0.18" - Standard, no suffix required
	0.11" - Add "8" suffix
	0.15" - Add "9" suffix

**Note:**

Consult factory for the complete list of available options.

END OF LIFE

**For more information on these products consult: [tech.support@psbel.com](mailto:tech.support@psbel.com)**

**NUCLEAR AND MEDICAL APPLICATIONS** - Products are not designed or intended for use as critical components in life support systems, equipment used in hazardous environments, or nuclear control systems.

**TECHNICAL REVISIONS** - The appearance of products, including safety agency certifications pictured on labels, may change depending on the date manufactured. Specifications are subject to change without notice.

## Looking for pricing, stock, or lifecycle information?

Click below to explore more details on WIN SOURCE:

- [⊖ View QLS25ZE-NT on WIN SOURCE](#)
- [⊖ Bel Power Solutions Information](#)

## Optimize Your Supply Chain with WIN SOURCE Solutions

- ✓ Global Sourcing Solution
- ✓ Obsolete Management
- ✓ Cost Control Management
- ✓ Shortage Management
- ✓ Alternative Solution
- ✓ Excess Inventory Management