



**THE DATASHEET OF
VSC8492YJD-12**



VSC8492

Dual Channel Universal 10G PHY with OTN/FEC and 1588v2/Y.1731

Microsemi's multichannel universal 10G PHY with OTN/FEC device provides highly flexible XAUI/SFI-4.2/TFI-5 to XFI transceiver capability with optional OTN wrapper for 10 GbE, 8G/10G Fibre Channel, OC-192/STM-64, and OTU2 applications.

The Microsemi VSC8492 dual Universal 10G PHYs with OTN-FEC are ideal for Carrier Ethernet switch/router and DWDM systems. Cost-efficient transponders based on the VSC8492 device cater to high volume 10 GbE/10G SONET/SDH and 8G/10G Fibre Channel. The VSC8492 device offers the ideal solution for multiport client and network interfaces on telecom transport linecards, transponders, and muxponders.

This highly integrated device supports 10 GbE LAN Carrier Ethernet networks, as well as WAN and OTN networks, with an extensive suite of 10 GbE mapping modes. With its 10G PHY XFI/SFI interfaces and G.709 FEC features, the VSC8492 dual device provides a seamless and direct interface to XFP and SFP+ optical modules.

The Microsemi VSC8492 dual device employs a bidirectional, independent channel architecture that can be used in both transponder (adaptation) and regenerator modes. Bidirectional performance monitoring is supported in both cases. The OTN mapper with FEC supports performance monitoring and maintenance features defined by the ITU-T G.709 standard, independent of the client signal carried, to simplify the operation of optical networks supporting various client signals.

The VSC8492 dual device includes two 10 Gbps dual-mode bidirectional UPI client interfaces and two 10 Gbps bidirectional serial interfaces for direct connection to XFP or SFP+ optics modules or 10G serial backplanes.

The Microsemi-defined Universal PHY Interface (UPI) delivers 10 GbE and 10 GFC as four-lane XAUI, 10G SONET/SDH as four TFI-5-like serial lanes, and OTU2/ODU2 as four-lane SFI4.2-like interface. UPI also supports twice-rate XAUI (DDR XAUI or RXAUI) as two lanes operating at 6.25 Gbps, and twice-rate SFI-4.2 for OTU2/ODU2.

Highlights

- Universal 10G PHY SerDes/CDR transceiver
- Integrated transponder support and XFI/SFI SerDes/CDR with redundant ports for protection switching
- 10 GbE LAN/WAN with SyncE and 1588v2 timestamp correction
- Integrated UPI switch with G.709 OTN/FEC and GFP wrapper
- Flexible 10 GbE XAUI/LAN/WAN mapping to OTU2 and overclocked OTU1e/2e

Applications

- N x 10G transponder/regenerator
- Protected N x 10G muxponder/ROADM
- Transponder/muxponder pizza box
- Ethernet or IP/MPLS switches/routers
- MSPP/MSTP N x 10G line cards

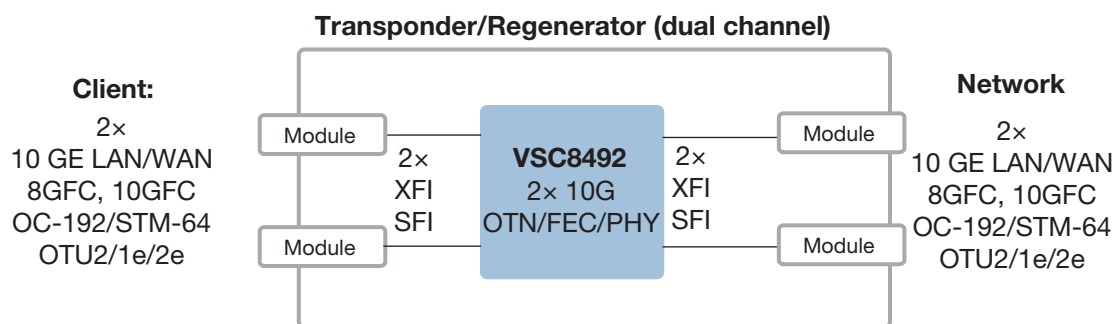

VSC8492

Dual Channel Universal 10G PHY with OTN/FEC and 1588v2/Y.1731

Key Benefits

- Enables universal line cards supporting 10 GbE LAN/WAN, 8 GFC, 10 GFC, OC-192/STM-64, and G.709 OTU2/1e/2e
- Lowest cost, power, and size for N x 10G line cards, as well as single-chip transponder/regenerator
- Direct connect to XFP and SFP+ client and network optics
- Direct connect to high-speed backplanes, MACs, SONET/SDH and G.709 OTN framers, and FPGAs using four-lane serial interface compatible with XAUI/RXAUI (10 GbE, 10 GFC), TFI-5 (SONET/SDH) and SFI-4.2 (OTU2)
- Wraps 10 GbE LAN/WAN, OC-192/STM-64, 8 GFC and 10 GFC clients in G.709 OTU2 with either standard or enhanced FEC
- May be configured to accept any 10G serial client, monitor and wrap it in G.709 OTN, and deliver it to UPI for connection to OTN switch, backplane, or other device
- Supports full-rate 10 GbE LAN transport using over-clocked OTU2e/1e (with or without fixed stuff), as well as GFP-mapping with or without preamble and ordered set retention (G.709 and G.Sup43)
- Supports 1+1 and 1:1 host interface protection switching
- Supports loopbacks toward both client and network interfaces

Key Specifications

- Universal PHY Support: 10 GbE LAN/WAN, OC-192/STM-64, 10 GFC, OTU2/1e/2e 4-lane
- 10 GbE/10 GFC XAUI/RXAUI, SONET/SDH TFI-5-compatible, OTU2 SFI-4.2-compatible
- XFI/SFI SerDes/CDR with EDC, including multitap Tx pre-emphasis and adaptive DFE Rx
- Redundant XFI/SFI serial interfaces connect directly to client or network XFP/SFP+ optics
- 10G serial interfaces connect directly to 10GBASE-KR backplanes
- OTN Mapper with RS(255,239) and G.975.1 eFECs
- 484-pin 23 mm x 23 mm FCBGA
- As low as 2.5 W per channel typical power dissipation

Related Products

Visit www.microsemi.com for information about these related products:

- Ethernet MACs and switches for Ethernet L2 aggregation and transport over 10 GbE LAN/WAN or OTN
- EoS Mappers for Ethernet or multiservice aggregation and transport over SONET/SDH optionally mapped into OTU2
- Asynchronous crosspoint switches

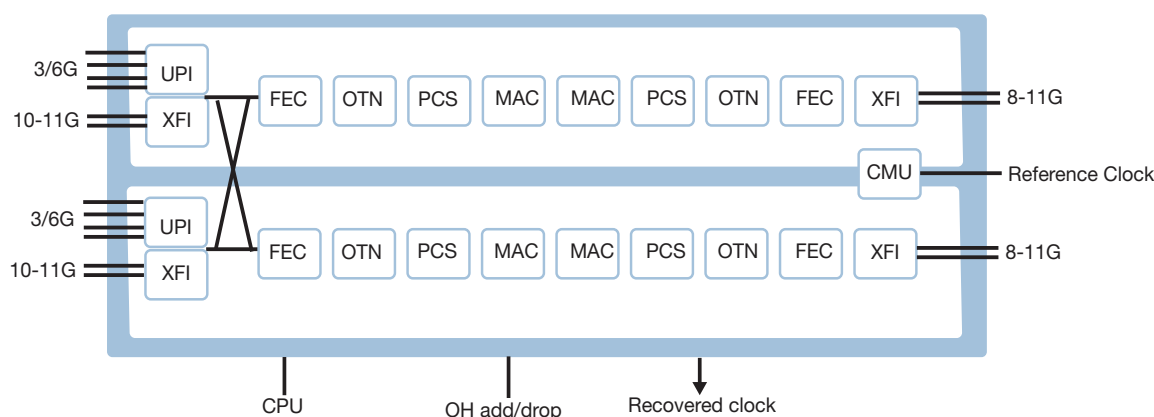

Microsemi Corporate Headquarters
 One Enterprise, Aliso Viejo, CA 92656 USA
 Within the USA: +1 (800) 713-4113
 Outside the USA: +1 (949) 380-6100
 Sales: +1 (949) 380-6136
 Fax: +1 (949) 215-4996
 email: sales.support@microsemi.com
www.microsemi.com

Microsemi Corporation (Nasdaq: MSCC) offers a comprehensive portfolio of semiconductor and system solutions for communications, defense and security, aerospace, and industrial markets. Products include high-performance and radiation-hardened analog mixed-signal integrated circuits, FPGAs, SoCs, and ASICs; power management products; timing and synchronization devices and precise time solutions; voice processing devices; RF solutions; discrete components; enterprise storage and communications solutions, security technologies, and scalable anti-tamper products; Ethernet solutions; Power-over-Ethernet ICs and midspans; custom design capabilities and services. Microsemi is headquartered in Aliso Viejo, California, and has approximately 4,800 employees worldwide. Learn more at www.microsemi.com.

Looking for pricing, stock, or lifecycle information?

Click below to explore more details on WIN SOURCE:

 [View VSC8492YJD-12 on WIN SOURCE](#)

 [Microchip Technology](#) Information

Optimize Your Supply Chain with WIN SOURCE Solutions

-  Global Sourcing Solution
-  Obsolete Management
-  Cost Control Management
-  Shortage Management
-  Alternative Solution
-  Excess Inventory Management