



**THE DATASHEET OF  
PT6645F**



- Wide Input Voltage Range:  
+8V to +25V
- Negative Output:  
-2.5V/4A to -15V/1.5A
- Adjustable Output Voltage
- 85% Efficiency
- Remote Sense Capability

The PT6640 series is a positive input to negative output line of Integrated Switching Regulators (ISRs). Designed for general purpose applications, the PT6640 series delivers a negative output voltage at up to 24W. The PT6640 is packaged in a 14-Pin SIP (Single In-line Package) and is available in a surface-mount configuration.

**Standard Application**

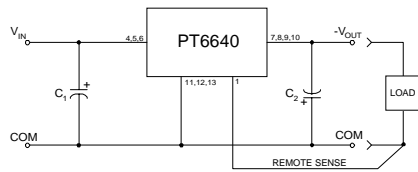

C<sub>1</sub> = Required 560µF electrolytic  
C<sub>2</sub> = Required 330µF electrolytic

**Pin-Out Information**

1	Remote Sense
2	Do Not Connect
3	Do Not Connect
4	+V <sub>in</sub>
5	+V <sub>in</sub>
6	+V <sub>in</sub>
7	-V <sub>out</sub>
8	-V <sub>out</sub>
9	-V <sub>out</sub>
10	-V <sub>out</sub>
11	GND
12	GND
13	GND
14	V <sub>out</sub> Adjust

**Ordering Information**

<b>PT6641</b>	= -3.3 Volts
<b>PT6642</b>	= -5.0 Volts
<b>PT6643</b>	= -12.0 Volts
<b>PT6644</b>	= -9.0 Volts
<b>PT6645</b>	= -15.0 Volts
<b>PT6646</b>	= -2.5 Volts

**PT Series Suffix (PT1234X)**

Case/Pin Configuration	Heat Spreader
Vertical Through-Hole	<b>P</b>
Horizontal Through-Hole	<b>D</b>
Horizontal Surface Mount	<b>E</b>

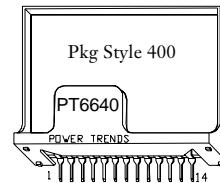

Note: Back surface of product is conducting metal

**Specifications**

Characteristics (T <sub>a</sub> = 25°C unless noted)	Symbols	Conditions	PT6640 SERIES			Units
			Min	Typ	Max	
Output Current	I <sub>o</sub>	T <sub>a</sub> = 60°C, 200 LFM, pkg P T <sub>a</sub> = 25°C, natural convection	0.1	—	(See Note 2)	A
		V <sub>o</sub> ≤ - 5.0V	0.1	—	4.0	
		V <sub>o</sub> = - 9.0V	0.1	—	2.5	
		V <sub>o</sub> = -12.0V	0.1	—	2.0	
		V <sub>o</sub> = -15.0V	0.1	—	1.5	
Input Voltage Range	V <sub>in</sub>	0.1A ≤ I <sub>o</sub> ≤ I <sub>o</sub> max	V <sub>o</sub> = -2.5V/3.3V +8	—	+27	V
			V <sub>o</sub> = -5.0V +8	—	+25	
			V <sub>o</sub> = -9.0V +8	—	+21	
			V <sub>o</sub> = -12.0V +8	—	+18	
			V <sub>o</sub> = -15.0V +8	—	+15	
Output Voltage Tolerance	ΔV <sub>o</sub>	Over V <sub>in</sub> range T <sub>a</sub> = -40°C to +65°C	V <sub>o</sub> -0.1	—	V <sub>o</sub> +0.1	V
Output Voltage Adjust Range	V <sub>oadj</sub>	Pin 14 to V <sub>o</sub> or ground	V <sub>o</sub> = -2.5V -1.8	—	-4.3	V
			V <sub>o</sub> = -3.3V -2.2	—	-4.7	
			V <sub>o</sub> = -5.0V -3.0	—	-6.5	
			V <sub>o</sub> = -9.0V -6.0	—	-10.2	
			V <sub>o</sub> = -12.0V -9.0	—	-13.6	
			V <sub>o</sub> = -15.0V -10.0	—	-17.0	
Line Regulation	Reg <sub>line</sub>	+9V ≤ V <sub>in</sub> ≤ +V <sub>in</sub> max, I <sub>o</sub> = I <sub>o</sub> max	—	±0.5	±1.0	% V <sub>o</sub>
Load Regulation	Reg <sub>load</sub>	V <sub>in</sub> = +12V, 0.1 ≤ I <sub>o</sub> ≤ I <sub>o</sub> max	—	±0.5	±1.0	% V <sub>o</sub>
V <sub>o</sub> Ripple/Noise	V <sub>n</sub>	V <sub>in</sub> = +12V, I <sub>o</sub> = I <sub>o</sub> max	—	3.0	—	% V <sub>o</sub>
Transient Response with C <sub>2</sub> = 330µF	t <sub>rr</sub> V <sub>os</sub>	I <sub>o</sub> step between 0.5xI <sub>o</sub> max and I <sub>o</sub> max	—	200	—	µSec
		V <sub>o</sub> over/undershoot	—	100	—	mV
Efficiency	η	V <sub>in</sub> = +12V, I <sub>o</sub> = 0.5x I <sub>o</sub> max	V <sub>o</sub> = -2.5V —	75	—	%
			V <sub>o</sub> = -3.3V —	79	—	
			V <sub>o</sub> = -5.0V —	83	—	
			V <sub>o</sub> = -9.0V/12.0V —	85	—	
			V <sub>o</sub> = -15.0V —	84	—	
		V <sub>in</sub> = +12V, I <sub>o</sub> = I <sub>o</sub> max	V <sub>o</sub> = -2.5V —	74	—	%
			V <sub>o</sub> = -3.3V —	77	—	
			V <sub>o</sub> = -5.0V —	80	—	
			V <sub>o</sub> = -9.0V/12.0V/15.0V —	84	—	
				84	—	

*Continued*

# PT6640 Series

24W 12V Input Positive to Negative Voltage Converter

## Specifications (continued)

Characteristics ( $T_a = 25^\circ\text{C}$ unless noted)	Symbols	Conditions	PT6640 SERIES			Units
			Min	Typ	Max	
Switching Frequency	$f_o$	$+9\text{V} \leq V_{in} \leq V_{in,max}$ Over $I_o$ range	500	550	600	kHz
Absolute Maximum Operating Temperature Range	$T_a$	Over $V_{in}$ range	-40	—	+85 <sup>(2)</sup>	$^\circ\text{C}$
Storage Temperature	$T_s$	—	-40	—	+125	$^\circ\text{C}$
Mechanical Shock	—	Per Mil-STD-883D, Method 2002.3	—	500	—	G's
Mechanical Vibration	—	Per Mil-STD-883D, Method 2007.2, 20-2000 Hz, soldered in a PC board	—	7.5	—	G's
Weight	—	—	—	14	—	grams

**Notes:** (1) The PT6640 Series requires a 330 $\mu\text{F}$ (output) and 560 $\mu\text{F}$ (input) electrolytic capacitors for proper operation in all applications.  
 (2) See Safe Operating Area curves or call the factory for guidance on thermal derating.

## TYPICAL CHARACTERISTICS

Characteristic Curves @12.0V  $V_{in}$  (See Note A)

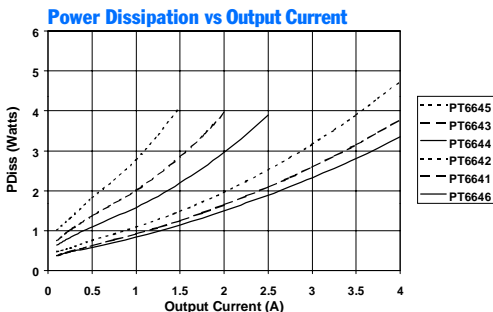
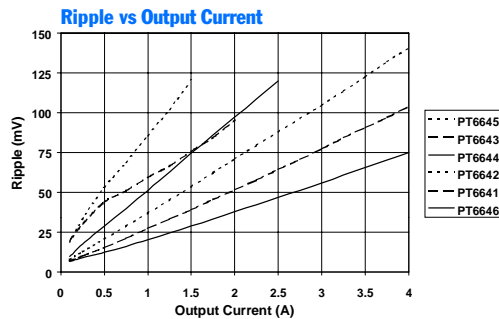
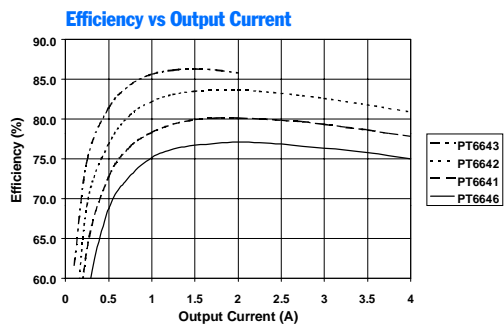

Safe Operating Area Curves (See Note B)

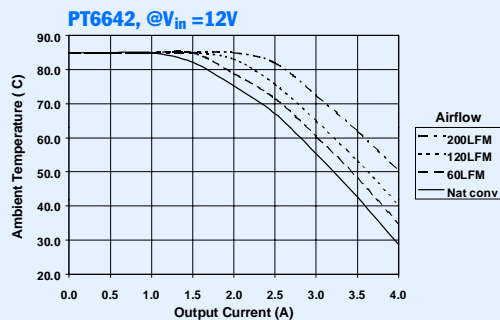

**Note A:** Characteristic data has been developed from actual products tested at 25 $^\circ\text{C}$ . This data is considered typical data for the DC-DC Converter.

**Note B:** SOA curves represent operating conditions at which internal components are at or below manufacturer's maximum rated operating temperatures.

PT6640 Series

## Adjusting the Output Voltage of the PT6640 24W Positive to Negative ISR Series

The negative output voltage of the Power Trends PT6640 series ISRs may be adjusted higher or lower than the factory trimmed pre-set voltage with the addition of a single external resistor. Table 1 gives the allowable adjustment range for each model in the series as  $V_a$  (min) and  $V_a$  (max).

**Adjust Up:** An increase in the negative output voltage is obtained by adding a resistor R2, between pin 14 ( $V_o$  adjust) and pins 7-10 ( $-V_{out}$ ).

**Adjust Down:** Adding a resistor (R1), between pin 14 ( $V_o$  adjust) and pins 11-13 (GND), decreases the output voltage magnitude.

Refer to Figure 1 and Table 2 for both the placement and value of the required resistor, either (R1) or R2 as appropriate.

**Notes:**

1. Use only a single 1% resistor in either the (R1) or R2 location. Place the resistor as close to the ISR as possible.
2. Never connect capacitors from  $V_o$  adjust to either GND,  $V_{out}$ , or the Remote Sense pin. Any capacitance added to the  $V_o$  adjust pin will affect the stability of the ISR.
3. If the Remote Sense feature is being used, connecting the resistor (R1) between pin 14 ( $V_o$  adjust) and pin 1 (Remote Sense) can benefit load regulation.
4. The maximum allowed input voltage ( $V_{in}$ ) will change as  $V_{out}$  is adjusted. The difference between the input voltage ( $V_{in}$ ) and the output voltage ( $V_{out}$ ) must not exceed 30V or  $10 \times V_{out}$ , whichever is less. Use one of the following formulas to determine the maximum allowed input voltage for the PT6640.

$$\begin{aligned} |V_{out}| \text{ greater than } 2.73V, \\ V_{in}(\text{max}) &= 30 - |V_{out}| \quad \text{Vdc} \end{aligned}$$

For example, if  $V_{out} = -12V$ ,

$$V_{in}(\text{max}) = 30 - |-12| = 18Vdc$$

$$\begin{aligned} |V_{out}| \text{ less than } 2.73V, \\ V_{in}(\text{max}) &= 10 \times |V_{out}| \quad \text{Vdc} \end{aligned}$$

Figure 1

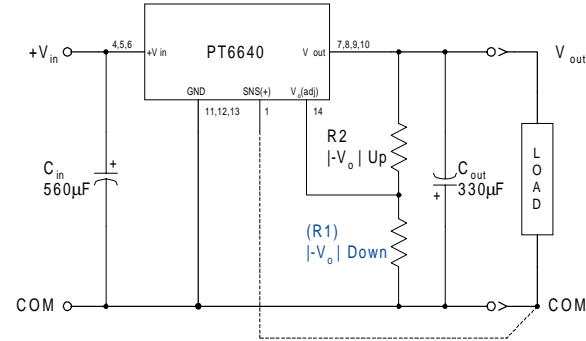

The values of (R1) [adjust down], and R2 [adjust up], can also be calculated using the following formulas.

$$(R1) = \frac{R_o (V_o - 1.25)(V_a - 1.25)}{1.25 (V_o - V_a)} - R_s \quad \text{k}\Omega$$

$$R2 = \frac{R_o (V_o - 1.25)}{V_a - V_o} - R_s \quad \text{k}\Omega$$

Where:  $V_o$  = Original  $V_{out}$  (magnitude)  
 $V_a$  = Adjusted  $V_{out}$  (magnitude)  
 $R_o$  = The resistance value in Table 1  
 $R_s$  = The series resistance from Table 1

**Table 1**  
PT6640 ADJUSTMENT AND FORMULA PARAMETERS

Series Pt #	PT6646	PT6641	PT6642	PT6644	PT6643	PT6645
<b><math>V_o</math> (nom)</b>	-2.5V	-3.3V	-5.0V	-9.0V	-12.0V	-15.0V
<b><math>V_a</math> (min)</b>	-1.8V	-2.2V	-3.0V	-6.0V	-9.0V	-10.0V
<b><math>V_a</math> (max)</b>	-4.3V	-4.7V	-6.5V	-10.2V	-13.6V	-17.0V
<b><math>R_o</math> (k<math>\Omega</math>)</b>	4.99	4.22	2.49	2.0	2.0	2.0
<b><math>R_s</math> (k<math>\Omega</math>)</b>	2.49	4.99	4.99	12.7	12.7	12.7

## PT6640 Series

**Table 2**

**PT6640 ADJUSTMENT RESISTOR VALUES**

Series Pt #	PT6646	PT6641	PT6642	Series Pt #	PT6644	PT6643	PT6645
Current	4Adc	4Adc	4Adc	Current	2.5Adc	2Adc	1.5Adc
V <sub>o</sub> (nom)	-2.5Vdc	-3.3Vdc	-5.0Vdc	V <sub>o</sub> (nom)	-9.0Vdc	-12.0Vdc	-15.0Vdc
V <sub>a</sub> (req'd)				V <sub>a</sub> (req'd)			
-1.8	(1.4)kΩ			-6.0	(6.9)kΩ		
-1.9	(2.9)kΩ			-6.2	(9.2)kΩ		
-2.0	(5.0)kΩ			-6.4	(11.9)kΩ		
-2.1	(8.1)kΩ			-6.6	(14.0)kΩ		
-2.2	(13.3)kΩ	(1.0)kΩ		-6.8	(18.6)kΩ		
-2.3	(23.7)kΩ	(2.3)kΩ		-7.0	(23.0)kΩ		
-2.4	(54.9)kΩ	(3.9)kΩ		-7.2	(28.3)kΩ		
-2.5		(5.8)kΩ		-7.4	(35.0)kΩ		
-2.6	59.9kΩ	(8.4)kΩ		-7.6	(43.5)kΩ		
-2.7	28.7kΩ	(11.7)kΩ		-7.8	(55.0)kΩ		
-2.8	18.3kΩ	(16.5)kΩ		-8.0	(71.0)kΩ		
-2.9	13.1kΩ	(23.6)kΩ		-8.2	(95.0)kΩ		
-3.0	10.0kΩ	(35.4)kΩ	(1.6)kΩ	-8.4	(135.0)kΩ		
-3.1	7.9kΩ	(59.0)kΩ	(2.3)kΩ	-8.6	(215.0)kΩ		
-3.2	6.4kΩ	(130.0)kΩ	(3.1)kΩ	-8.8	(455.0)kΩ		
-3.3	5.3kΩ		(4.0)kΩ	-9.0		(31.7)kΩ	
-3.4	4.4kΩ	81.5kΩ	(5.1)kΩ	-9.2	64.8kΩ	(36.1)kΩ	
-3.5	3.8kΩ	38.3kΩ	(6.2)kΩ	-9.4	26.1kΩ	(41.2)kΩ	
-3.6	3.2kΩ	23.8kΩ	(7.6)kΩ	-9.6	13.1kΩ	(47.1)kΩ	
-3.7	2.7kΩ	16.6kΩ	(9.1)kΩ	-9.8	6.7kΩ	(54.1)kΩ	
-3.8	2.3kΩ	12.3kΩ	(10.9)kΩ	-10.0	2.8kΩ	(62.6)kΩ	(25.8)kΩ
-3.9	2.0kΩ	9.4kΩ	(13.0)kΩ	-10.2	0.2kΩ	(72.8)kΩ	(28.3)kΩ
-4.0	1.7kΩ	7.4kΩ	(15.6)kΩ	-10.4		(85.7)kΩ	(31.1)kΩ
-4.1	1.4kΩ	5.8kΩ	(18.7)kΩ	-10.6		(102.0)kΩ	(34.1)kΩ
-4.2	1.2kΩ	4.6kΩ	(22.6)kΩ	-10.8		(124.0)kΩ	(37.3)kΩ
-4.3	1.0kΩ	3.7kΩ	(27.6)kΩ	-11.0		(155.0)kΩ	(40.9)kΩ
-4.4		2.9kΩ	(34.2)kΩ	-11.2		(201.0)kΩ	(44.9)kΩ
-4.5		2.2kΩ	(43.6)kΩ	-11.4		(278.0)kΩ	(49.3)kΩ
-4.6		1.7kΩ	(57.6)kΩ	-11.6		(432.0)kΩ	(54.3)kΩ
-4.7		1.2kΩ	(80.9)kΩ	-11.8		(895.0)kΩ	(59.8)kΩ
-4.8			(128.0)kΩ	-12.0			(66.1)kΩ
-4.9			(268.0)kΩ	-12.2		94.8kΩ	(73.3)kΩ
-5.0				-12.4		41.1kΩ	(81.6)kΩ
-5.1			88.4kΩ	-12.6		23.1kΩ	(91.3)kΩ
-5.2			41.7kΩ	-12.8		14.2kΩ	(103.0)kΩ
-5.3			26.1kΩ	-13.0		8.8kΩ	(117.0)kΩ
-5.4			18.4kΩ	-13.2		5.2kΩ	(133.0)kΩ
-5.5			13.7kΩ	-13.4		2.7kΩ	(154.0)kΩ
-5.6			10.6kΩ	-13.6		0.7kΩ	(181.0)kΩ
-5.7			8.4kΩ	-13.8			(217.0)kΩ
-5.8			6.7kΩ	-14.0			(268.0)kΩ
-5.9			5.4kΩ	-14.2			(343.0)kΩ
-6.0			4.4kΩ	-14.5			(570.0)kΩ
-6.1			3.5kΩ	-15.0			
-6.2			2.8kΩ	-15.5			42.3kΩ
-6.3			2.2kΩ	-16.0			14.8kΩ
-6.4			1.7kΩ	-16.5			5.6kΩ
-6.5			1.2kΩ	-17.0			1.1kΩ

R1 = (Blue) R2 = Black

## **IMPORTANT NOTICE**

Texas Instruments and its subsidiaries (TI) reserve the right to make changes to their products or to discontinue any product or service without notice, and advise customers to obtain the latest version of relevant information to verify, before placing orders, that information being relied on is current and complete. All products are sold subject to the terms and conditions of sale supplied at the time of order acknowledgment, including those pertaining to warranty, patent infringement, and limitation of liability.

TI warrants performance of its semiconductor products to the specifications applicable at the time of sale in accordance with TI's standard warranty. Testing and other quality control techniques are utilized to the extent TI deems necessary to support this warranty. Specific testing of all parameters of each device is not necessarily performed, except those mandated by government requirements.

Customers are responsible for their applications using TI components.

In order to minimize risks associated with the customer's applications, adequate design and operating safeguards must be provided by the customer to minimize inherent or procedural hazards.

TI assumes no liability for applications assistance or customer product design. TI does not warrant or represent that any license, either express or implied, is granted under any patent right, copyright, mask work right, or other intellectual property right of TI covering or relating to any combination, machine, or process in which such semiconductor products or services might be or are used. TI's publication of information regarding any third party's products or services does not constitute TI's approval, warranty or endorsement thereof.

## **IMPORTANT NOTICE**

Texas Instruments and its subsidiaries (TI) reserve the right to make changes to their products or to discontinue any product or service without notice, and advise customers to obtain the latest version of relevant information to verify, before placing orders, that information being relied on is current and complete. All products are sold subject to the terms and conditions of sale supplied at the time of order acknowledgment, including those pertaining to warranty, patent infringement, and limitation of liability.

TI warrants performance of its semiconductor products to the specifications applicable at the time of sale in accordance with TI's standard warranty. Testing and other quality control techniques are utilized to the extent TI deems necessary to support this warranty. Specific testing of all parameters of each device is not necessarily performed, except those mandated by government requirements.

Customers are responsible for their applications using TI components.

In order to minimize risks associated with the customer's applications, adequate design and operating safeguards must be provided by the customer to minimize inherent or procedural hazards.

TI assumes no liability for applications assistance or customer product design. TI does not warrant or represent that any license, either express or implied, is granted under any patent right, copyright, mask work right, or other intellectual property right of TI covering or relating to any combination, machine, or process in which such semiconductor products or services might be or are used. TI's publication of information regarding any third party's products or services does not constitute TI's approval, warranty or endorsement thereof.

## Looking for pricing, stock, or lifecycle information?

Click below to explore more details on WIN SOURCE:

 [View PT6645F on WIN SOURCE](#)

 [Texas Instruments](#) Information

## Optimize Your Supply Chain with WIN SOURCE Solutions

-  Global Sourcing Solution
-  Obsolete Management
-  Cost Control Management
-  Shortage Management
-  Alternative Solution
-  Excess Inventory Management