





## GaAs MMIC I/Q UPCONVERTER 37 - 40 GHz

### Typical Applications

The HMC6787ALC5A is ideal for:

- Point-to-Point and Point-to-Multi-Point Radio
- Military Radar, EW & ELINT
- Satellite Communications
- Sensors

### Features

- Conversion Gain: 10 dB
- Sideband Rejection: 17 dBc
- High Output IP3: +27 dBm
- 16 Lead 5x5 mm SMT Ceramic Package: 25 mm<sup>2</sup>

### Functional Diagram

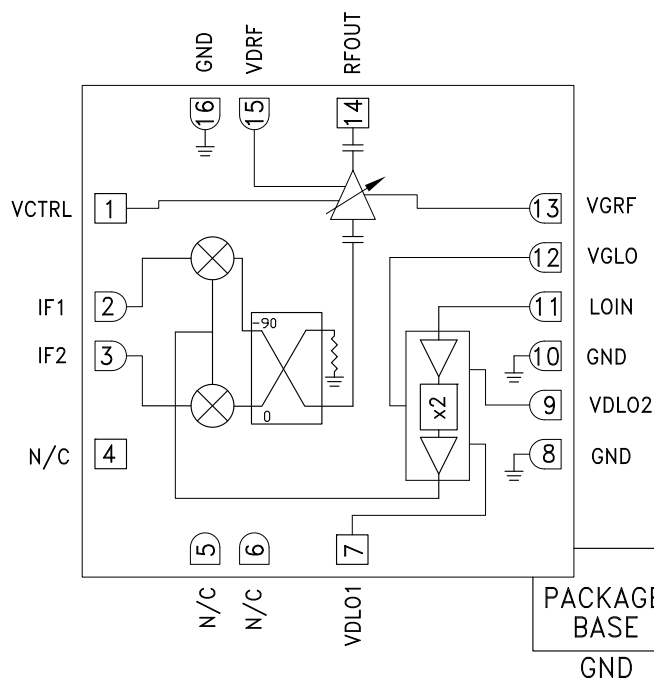

### General Description

The HMC6787ALC5A is a compact GaAs MMIC I/Q variable gain upconverter in a leadless RoHS compliant SMT package. This device provides a small signal conversion gain of 11 dB with 17 dBc of sideband rejection, and 13 dB of gain control. The HMC6787ALC5A utilizes a RF variable gain amplifier preceded by an I/Q mixer where the LO is driven by a X2 multiplier. IF1 and IF2 mixer inputs are provided and an external 90° hybrid is needed to select the required sideband. The I/Q mixer topology reduces the need for filtering of the unwanted sideband. The HMC6787ALC5A is a much smaller alternative to hybrid style single sideband upconverter assemblies and it eliminates the need for wire bonding by allowing the use of surface mount manufacturing techniques.

**Electrical Specifications** <sup>[1][2]</sup>,  $T_A = +25^\circ\text{C}$ ,  $IF = 2350\text{ MHz}$ ,  
 $LO = +4\text{ dBm}$ ,  $VDLO1, 2 = +3\text{V}$ ,  $IDLO = 150\text{ mA}$ ,  $VDRF = +3\text{V}$ ,  $IDRF = 200\text{ mA}$ ,  $USB$  <sup>[1][2]</sup>

Parameter	Min.	Typ.	Max.	Units
Frequency Range, RF		37 - 40		GHz
Frequency Range, LO		16.5 - 22		GHz
Frequency Range, IF		0 - 4		GHz
Conversion Gain	7	10		dB
Sideband Rejection		17		dBc
Dynamic Range		13		dB
1 dB Compression (Output)		14		dBm
IP3 (Output)		26		dBm
LO / RF Isolation		15		dB
Supply Current IDLO <sup>[2]</sup>		150		mA
Supply Current IDRF <sup>[2]</sup>		200		mA

[1] Unless otherwise noted all measurements performed with low side LO, IF = 2350 MHz and external IF 90° hybrid.

[2] Adjust V<sub>gg</sub> between -2 to 0V to achieve IDLO = 150 mA and IDRF = 200 mA Typical.



**GaAs MMIC I/Q UPCONVERTER  
37 - 40 GHz**

**Data Taken as SSB Upconverter with External IF 90° Hybrid, IF = 2350 MHz**

**Conversion Gain, USB vs. Temperature**

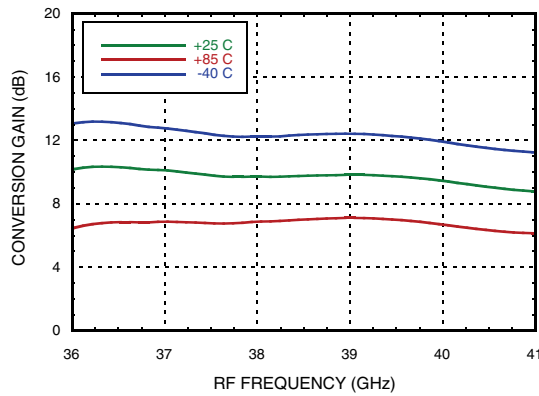

**Conversion Gain, USB vs. LO Drive**

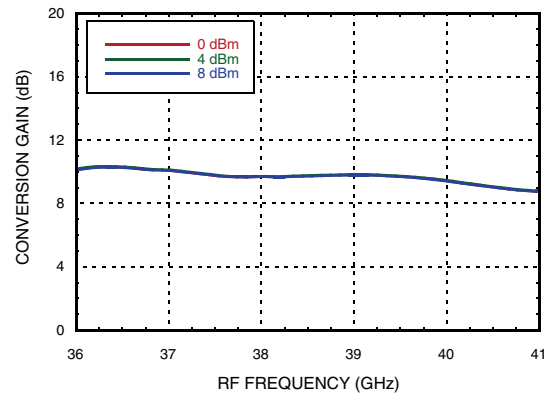

**RF Return Loss vs. Temperature**

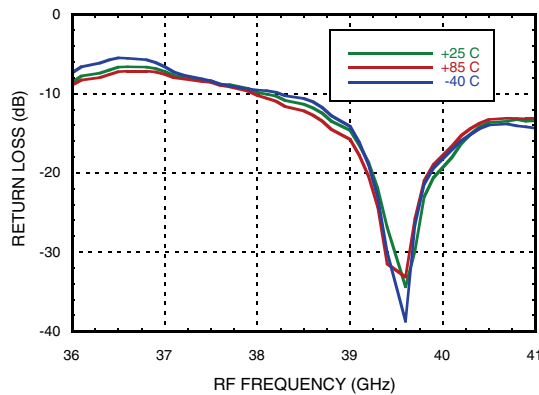

**LO Return Loss vs. Temperature**

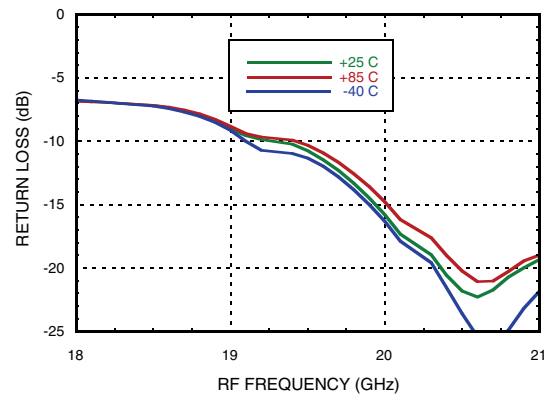

**IF Return Loss [1]**

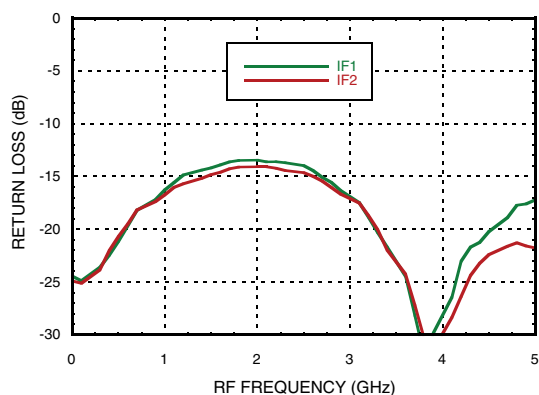

**Sideband Rejection vs. Temperature**

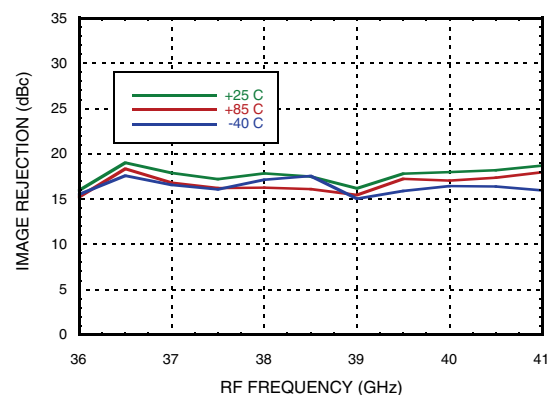

[1] Data taken without external IF 90° hybrid



**GaAs MMIC I/Q UPCONVERTER  
37 - 40 GHz**

**Data Taken as SSB Upconverter with External IF 90° Hybrid, IF = 2350 MHz**

**Input P1dB, USB vs. Temperature**

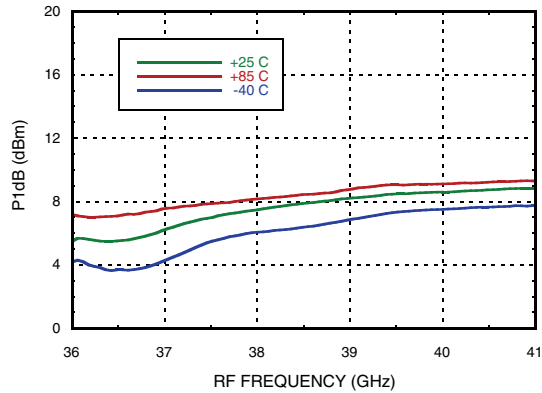

**Output P1dB, USB vs. Temperature**

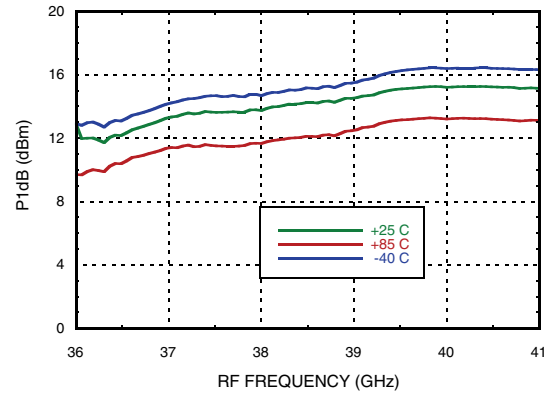

**Input IP3, USB vs. Temperature**

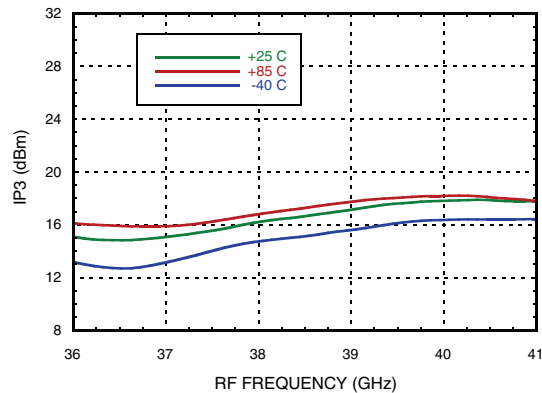

**Output IP3, USB vs. Temperature**

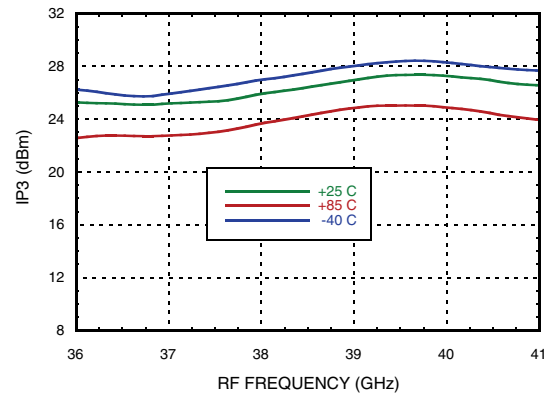

**Conversion Gain, USB vs. Control Voltage**

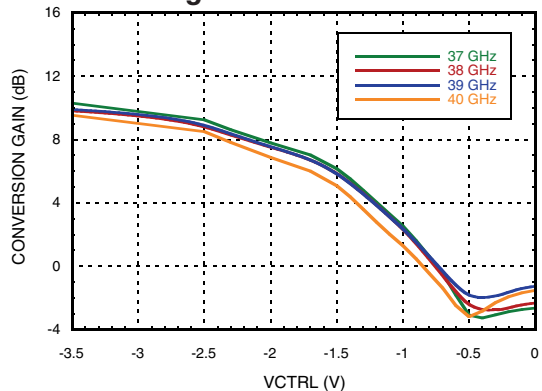

**Input IP3, USB vs. Control Voltage**

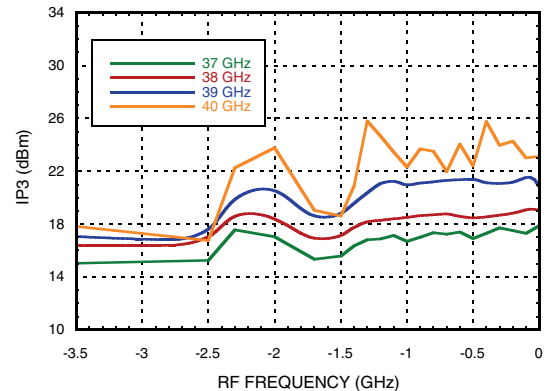

Information furnished by Analog Devices is believed to be accurate and reliable. However, no responsibility is assumed by Analog Devices for its use, nor for any infringements of patents or other rights of third parties that may result from its use. Specifications subject to change without notice. No license is granted by implication or otherwise under any patent or patent rights of Analog Devices. Trademarks and registered trademarks are the property of their respective owners.

For price, delivery, and to place orders: Analog Devices, Inc., One Technology Way, P.O. Box 9106, Norwood, MA 02062-9106 Phone: 781-329-4700 • Order online at [www.analog.com](http://www.analog.com) Application Support: Phone: 1-800-ANALOG-D



**GaAs MMIC I/Q UPCONVERTER  
37 - 40 GHz**

**Data Taken as SSB Upconverter with External IF 90° Hybrid, IF = 2350 MHz**

**Output IP3, USB vs. Control Voltage**

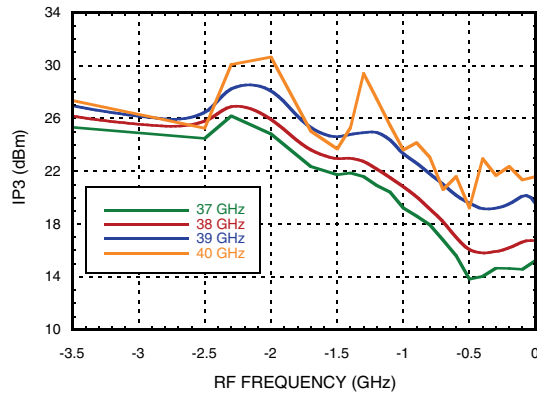

**LO Isolation**

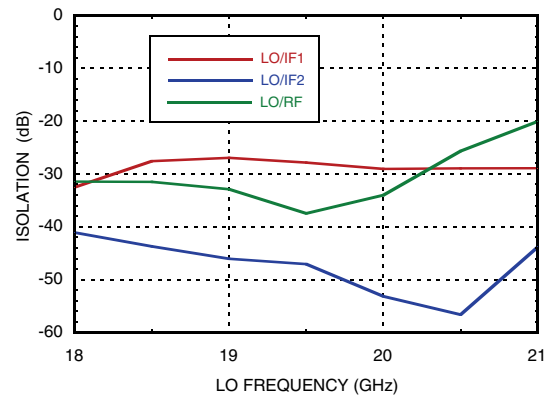

**2LO Isolation**

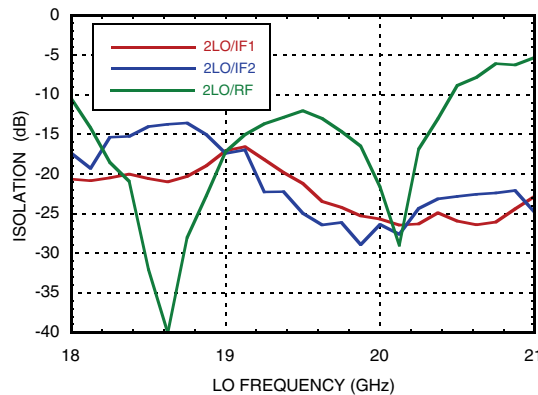



**GaAs MMIC I/Q UPCONVERTER  
37 - 40 GHz**

*Data Taken as SSB Upconverter with External IF 90° Hybrid, IF = 3000 MHz*

**Conversion Gain, USB vs. Temperature**

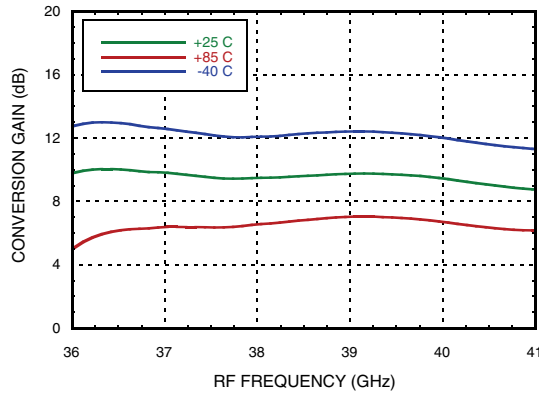

**Conversion Gain, USB vs. LO Drive**

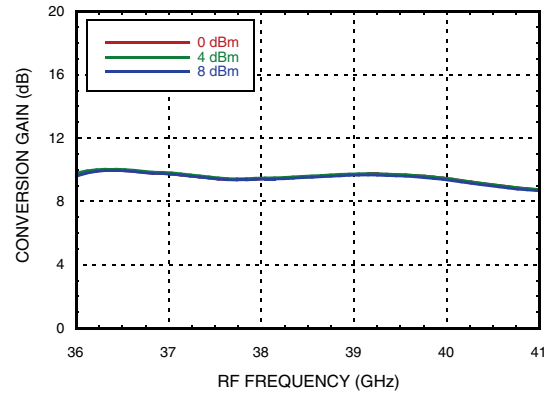

**Sideband Rejection vs. Temperature**

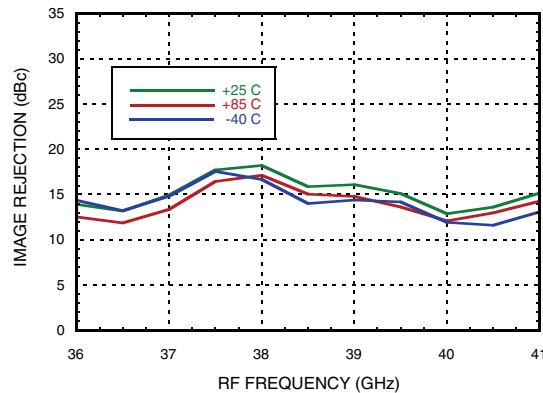

**Input IP3, USB vs. Temperature**

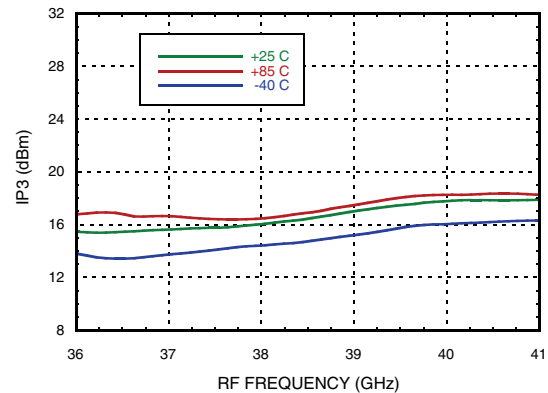

**Output IP3, USB vs. Temperature**

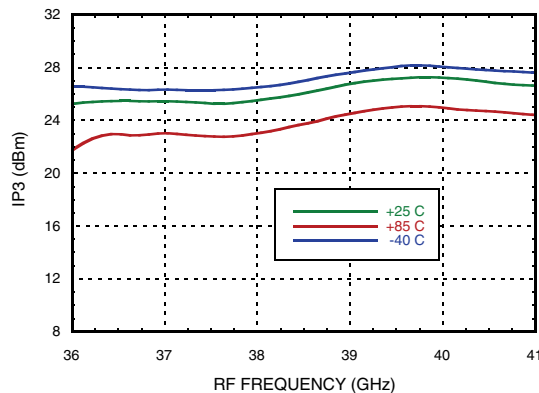

**Conversion Gain, USB vs. Control Voltage**

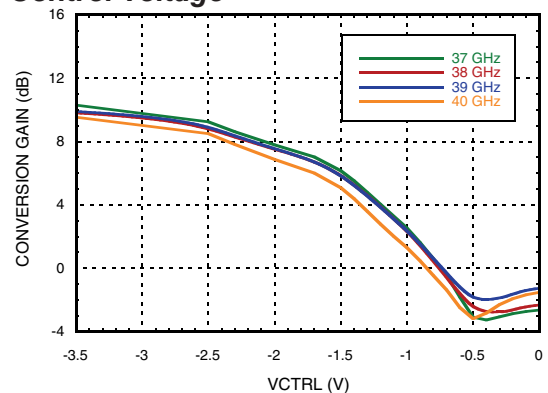

Information furnished by Analog Devices is believed to be accurate and reliable. However, no responsibility is assumed by Analog Devices for its use, nor for any infringements of patents or other rights of third parties that may result from its use. Specifications subject to change without notice. No license is granted by implication or otherwise under any patent or patent rights of Analog Devices. Trademarks and registered trademarks are the property of their respective owners.

For price, delivery, and to place orders: Analog Devices, Inc., One Technology Way, P.O. Box 9106, Norwood, MA 02062-9106 Phone: 781-329-4700 • Order online at [www.analog.com](http://www.analog.com) Application Support: Phone: 1-800-ANALOG-D



**GaAs MMIC I/Q UPCONVERTER  
37 - 40 GHz**

*Data Taken as SSB Upconverter with External IF 90° Hybrid, IF = 3000 MHz*

**Input IP3, USB vs. Control Voltage**

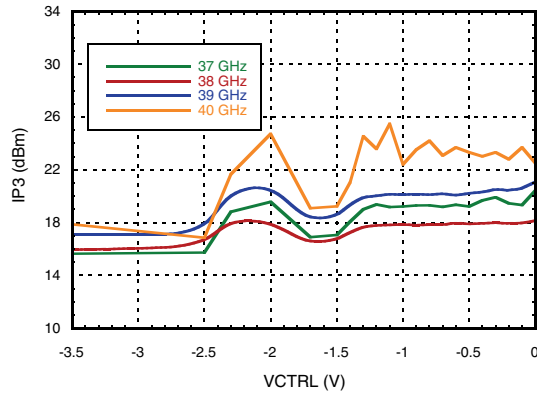

**Output IP3, USB vs. Control Voltage**

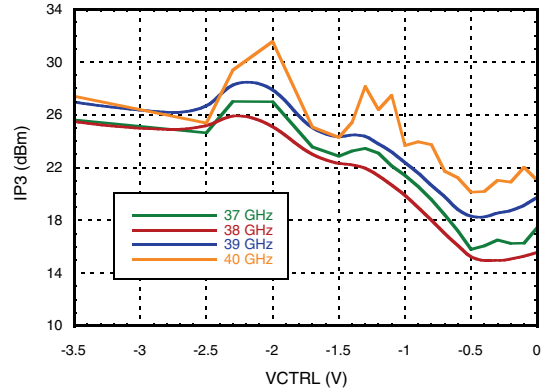

Information furnished by Analog Devices is believed to be accurate and reliable. However, no responsibility is assumed by Analog Devices for its use, nor for any infringements of patents or other rights of third parties that may result from its use. Specifications subject to change without notice. No license is granted by implication or otherwise under any patent or patent rights of Analog Devices. Trademarks and registered trademarks are the property of their respective owners.

For price, delivery, and to place orders: Analog Devices, Inc., One Technology Way, P.O. Box 9106, Norwood, MA 02062-9106 Phone: 781-329-4700 • Order online at [www.analog.com](http://www.analog.com) Application Support: Phone: 1-800-ANALOG-D



**GaAs MMIC I/Q UPCONVERTER  
37 - 40 GHz**

*Data Taken as SSB Upconverter with External IF 90° Hybrid, IF = 3750 MHz*

**Conversion Gain, USB vs. Temperature**

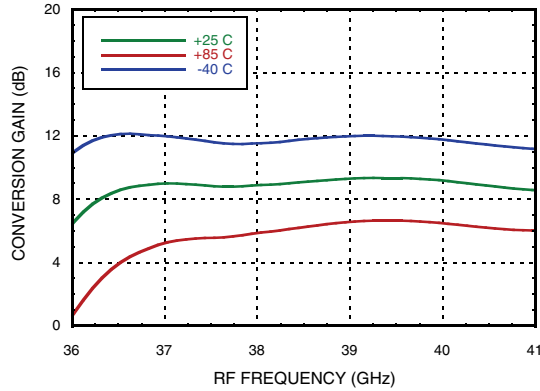

**Conversion Gain, USB vs. LO Drive**

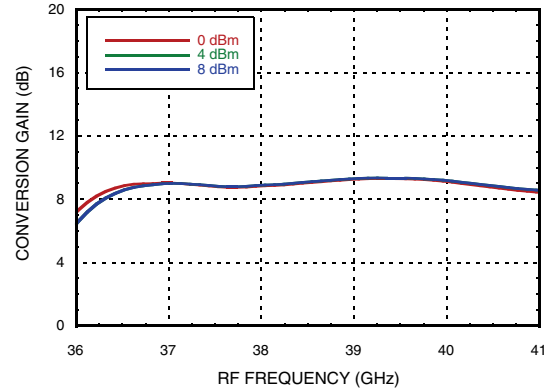

**Sideband Rejection vs. Temperature**

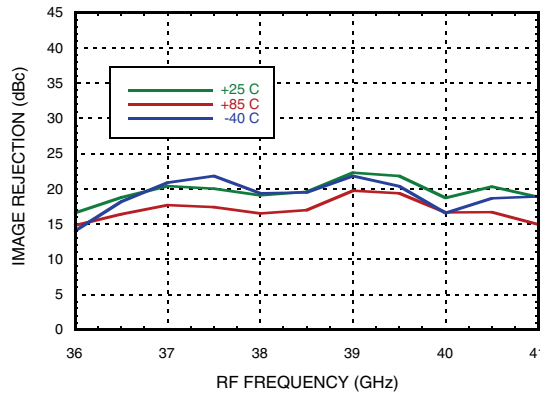

**Input IP3, USB vs. Temperature**

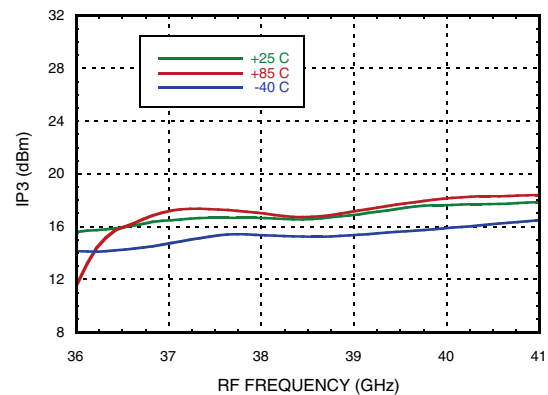

**Output IP3, USB vs. Temperature**

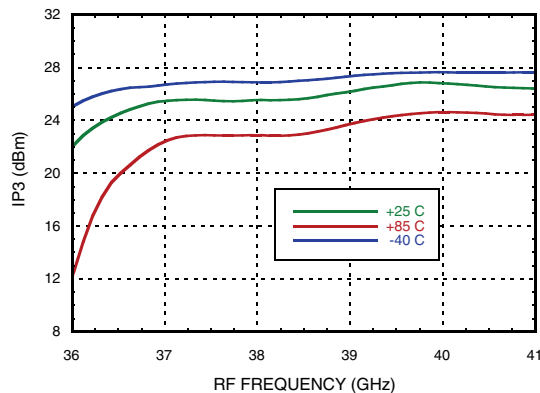

**Conversion Gain, USB vs. Control Voltage**

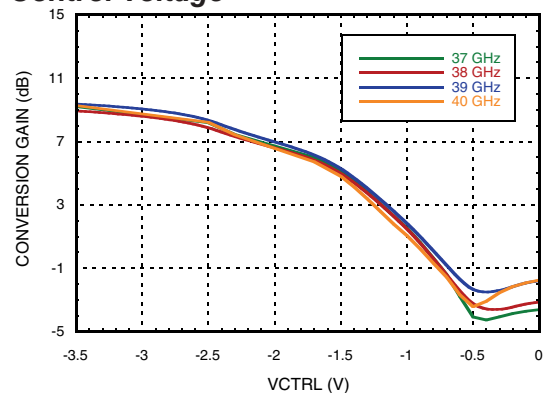

Information furnished by Analog Devices is believed to be accurate and reliable. However, no responsibility is assumed by Analog Devices for its use, nor for any infringements of patents or other rights of third parties that may result from its use. Specifications subject to change without notice. No license is granted by implication or otherwise under any patent or patent rights of Analog Devices. Trademarks and registered trademarks are the property of their respective owners.

For price, delivery, and to place orders: Analog Devices, Inc., One Technology Way, P.O. Box 9106, Norwood, MA 02062-9106 Phone: 781-329-4700 • Order online at [www.analog.com](http://www.analog.com) Application Support: Phone: 1-800-ANALOG-D



**GaAs MMIC I/Q UPCONVERTER  
37 - 40 GHz**

**Data Taken as SSB Upconverter with External IF 90° Hybrid, IF = 3750 MHz**

**Input IP3, LSB vs. Control Voltage**

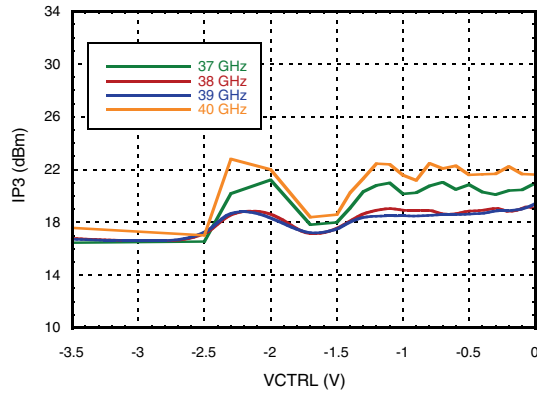

**Output IP3, LSB vs. Control Voltage**

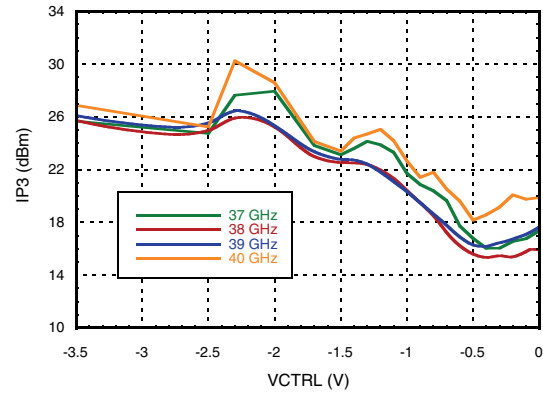

[1] Data taken without external IF 90° hybrid  
 [2] All values in dBc below RF power level (2LO + IF) USB



**GaAs MMIC I/Q UPCONVERTER  
37 - 40 GHz**

*Data Taken as SSB Upconverter with External IF 90° Hybrid, IF = 1000 MHz*

**Conversion Gain, USB vs. Temperature**

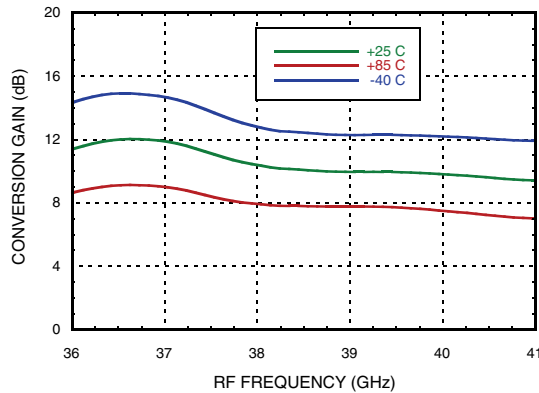

**Conversion Gain, USB vs. LO Drive**

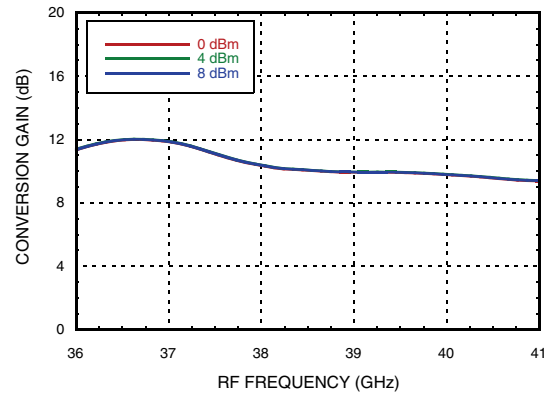

**Sideband Rejection vs. Temperature**

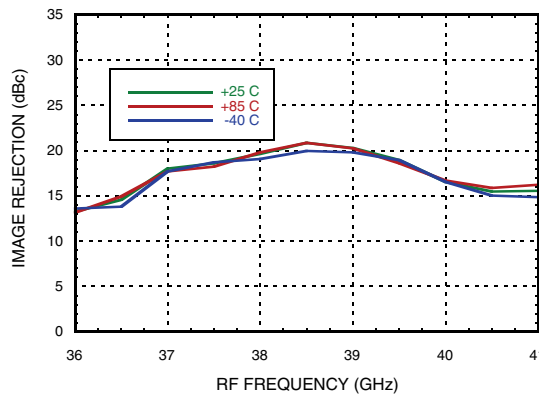

**Input IP3, USB vs. Temperature**

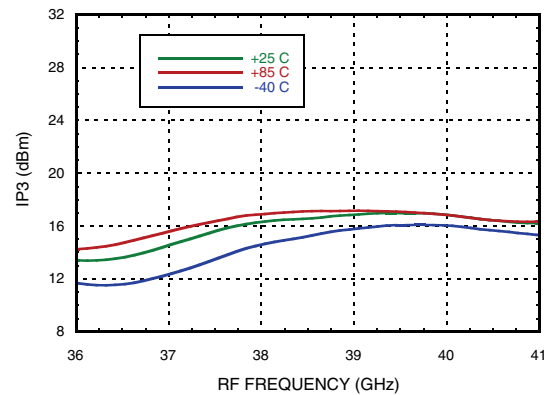

**Output IP3, USB vs. Temperature**

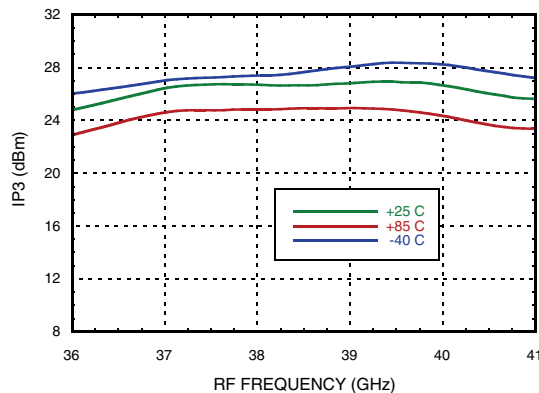

**Conversion Gain, USB vs. Control Voltage**

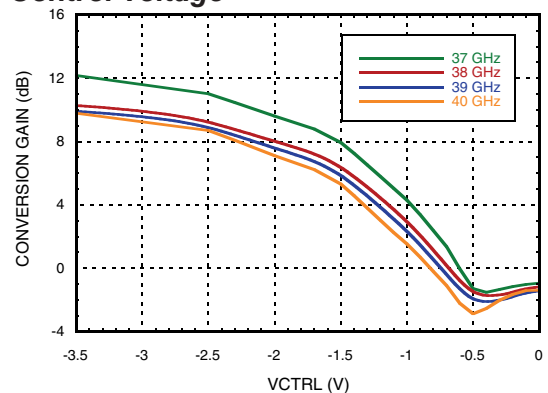

Information furnished by Analog Devices is believed to be accurate and reliable. However, no responsibility is assumed by Analog Devices for its use, nor for any infringements of patents or other rights of third parties that may result from its use. Specifications subject to change without notice. No license is granted by implication or otherwise under any patent or patent rights of Analog Devices. Trademarks and registered trademarks are the property of their respective owners.

For price, delivery, and to place orders: Analog Devices, Inc., One Technology Way, P.O. Box 9106, Norwood, MA 02062-9106 Phone: 781-329-4700 • Order online at [www.analog.com](http://www.analog.com) Application Support: Phone: 1-800-ANALOG-D



**GaAs MMIC I/Q UPCONVERTER  
37 - 40 GHz**

**Data Taken as SSB Upconverter with External IF 90° Hybrid, IF = 1000 MHz**

**Input IP3, LSB vs. Control Voltage**

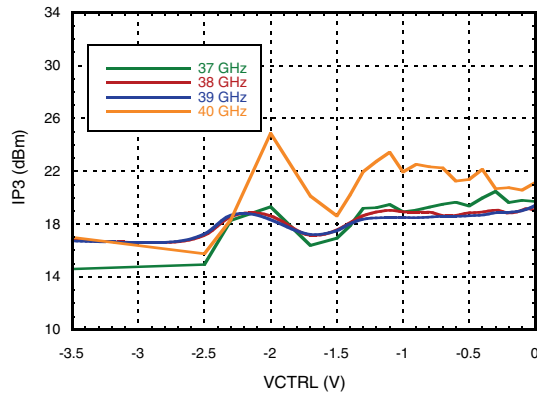

**Output IP3, LSB vs. Control Voltage**

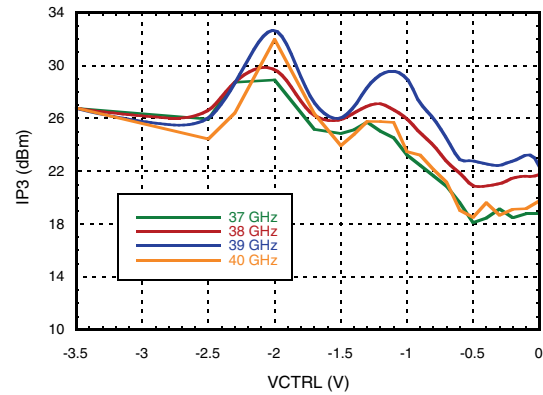



## GaAs MMIC I/Q UPCONVERTER 37 - 40 GHz

### MxN Spurious Outputs [1][2]

mIF	nLO				
	0	1	2	3	4
0		31	4		
1	54	65	0		
2	62	71	40		
3	122	90	62		
4	122	122	122		
5	122	122	122		

IF = 2.35 GHz @ -8 dBm  
LO = 17.575 GHz @ +4 dBm

### MxN Spurious Outputs [1][2]

mIF	nLO				
	0	1	2	3	4
0		32	5		
1	56	59	0		
2	59	79	64		
3	118	118	68		
4	118	118	118		
5	118	118	118		

IF = 3 GHz @ -8 dBm  
LO = 17.75 GHz @ +4 dBm

### MxN Spurious Outputs [1][2]

mIF	nLO				
	0	1	2	3	4
0		31	5		
1	56	51	0		
2	61	70	48		
3	118	84	58		
4	122	122	122		
5	122	122	122		

IF = 4 GHz @ -8 dBm  
LO = 17.75 GHz @ +4 dBm

### MxN Spurious Outputs [1][2]



mIF	nLO				
	0	1	2	3	4
0		34	4		
1	59	54	0		
2	71	72	39		
3	120	86	62		
4	120	122	120		
5	120	120	120		

IF = 1 GHz @ -8 dBm  
LO = 18.5 GHz @ +4 dBm

[1] Data taken without external IF 90° hybrid  
[2] All values in dBc below RF power level (2LO + IF) USB

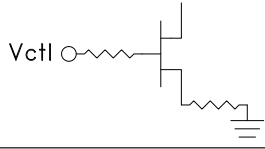
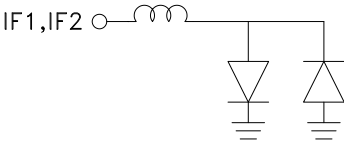
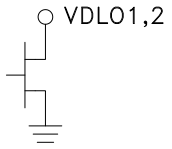

### Pin Descriptions

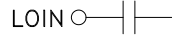
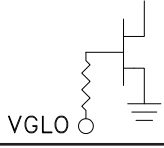
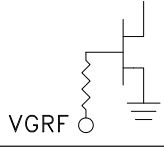
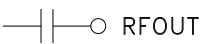
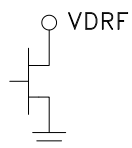
Pin Number	Function	Description	Interface Schematic
1	VCTRL	Vary Vctrl from -3.5V to 0V to adjust conversion gain. Maximum Gain occurs at -3.5V. Current draw << 1 mA.	
2	IF1	Pins are DC coupled Must not source or sink more than +/- 3 mA for applications requiring operation to DC.	
3	IF2		
4, 5, 6	N/C	No connection required. The pins are not connected internally; however, all data shown herein was measured with these pins connected to RF/DC ground externally.	
7	VDLO1	Bias for multiplier input buffer amp. The recommended DC voltage is +3V.	
9	VDLO2	Bias for multiplier input buffer amp. The recommended DC voltage is +3V.	
8, 10, 16	GND	These pins and package bottom must be connected to RF/DC ground.	
11	LOIN	LO input port. The recommended LO power is 0 to 8 dBm.	
12	VGLO	Adjust VGLO for -1V to 0V to set the multiplier quiescent current to 150 mA ( 200 - 230 mA with LO Drive ).	
13	VGRF	Adjust VGRF for -1V to 0V to set the VGA current to 200 mA.	
14	RFOUT	RF output port.	
15	VDRF	Bias voltage for the VGA. The recommended DC voltage is +3V.	



**GaAs MMIC I/Q UPCONVERTER  
37 - 40 GHz**

**Typical Application**

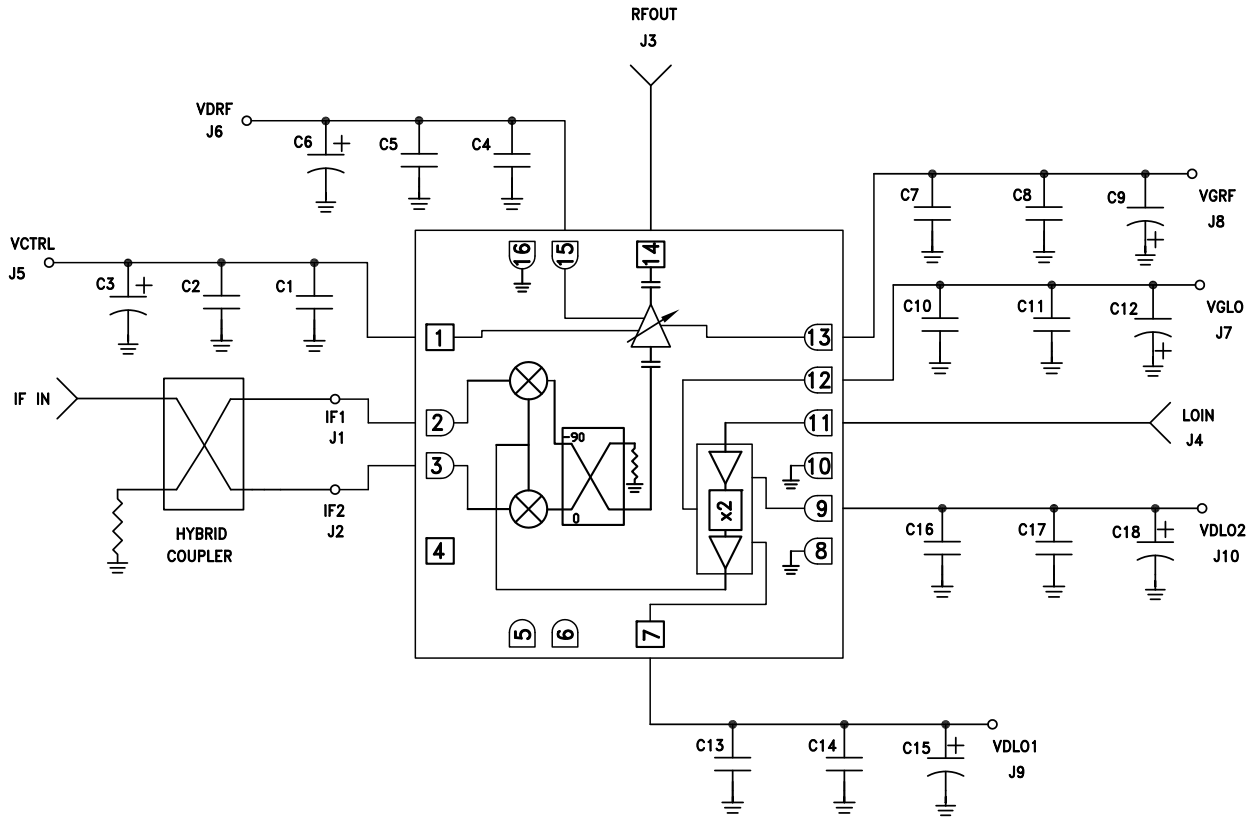

C1, C4, C7, C10, C13, C16	100 pF Capacitor, 0402 Pkg.
C2, C5, C8, C11, C14, C17	0.1 uF Capacitor, 0402 Pkg.
C3, C6, C9, C12, C15, C18	4.7 μF Capacitor, Case A Pkg.



## GaAs MMIC I/Q UPCONVERTER 37 - 40 GHz

### Absolute Maximum Ratings

IF Input	+20 dBm
LO Input	+10 dBm
Channel Temperature	175 °C
Continuous Pdiss (T = 85°C) (derate 18.3 mW/°C above 85°C)	1.65 W
Thermal Resistance (channel to ground paddle)	54.6 °C/W
Storage Temperature	-65 to +150 °C
Operating Temperature	-40 to +85 °C
ESD Sensitivity (HBM)	Class1A



ELECTROSTATIC SENSITIVE DEVICE  
OBSERVE HANDLING PRECAUTIONS

### Outline Drawing

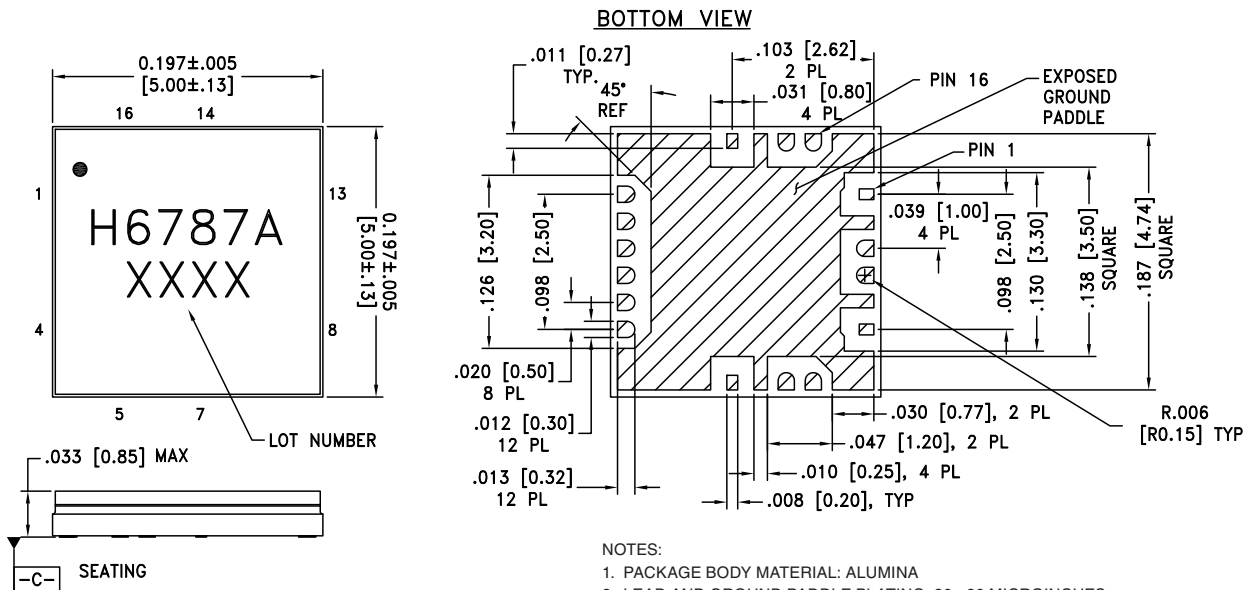

### Package Information

Part Number	Package Body Material	Lead Finish	MSL Rating	Package Marking [2]
HMC6787ALC5A	Alumina, White	Gold over Nickel	MSL3 [1]	6768A XXXX

[1] Max peak reflow temperature of 260 °C

[2] 4-Digit lot number XXXX



**Evaluation PCB**

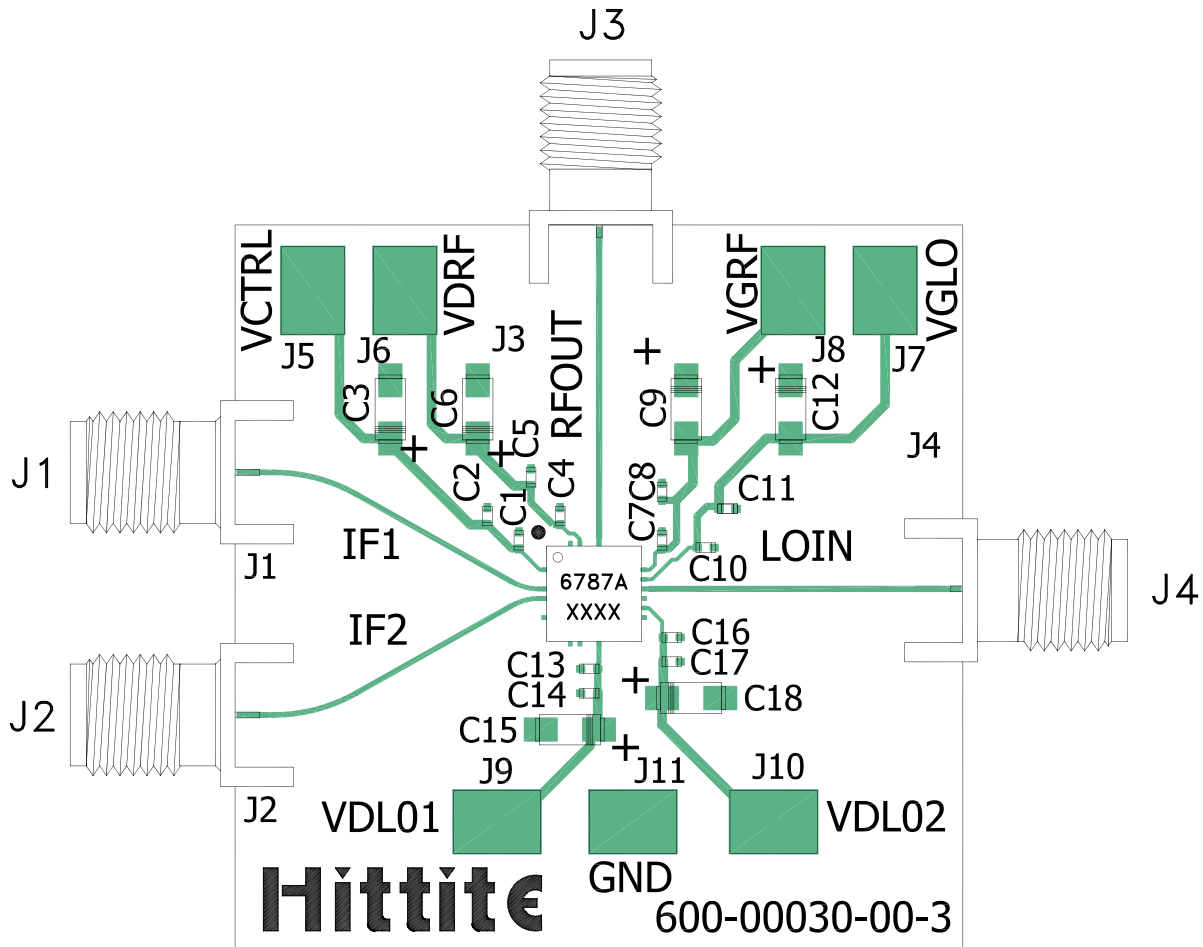

**List of Materials for Evaluation PCB Eval01-HMC6787ALC5A [1]**

Item	Description
J1, J2	SMA Connector
J3, J4	K-Connector SRI
J5 - J11	DC Pins
C1, C4, C7, C10, C13, C16	100 pF Capacitor, 0402 Pkg.
C2, C5, C8, C11, C14, C17	0.1 uF Capacitor, 0402 Pkg.
C3, C6, C9, C12, C15, C18	4.7 uF Capacitor, Case A
U1	HMC6787ALC5A Upconverter
PCB [2]	600-00030-00 Evaluation Board

[1] Reference this number when ordering complete evaluation PCB

[2] Circuit Board Material: Arlon 25FR, FR4 or Rogers 4350

The circuit board used in the application should use RF circuit design techniques. Signal lines should have 50 Ohm impedance while the package ground leads and exposed paddle should be connected directly to the ground plane similar to that shown. A sufficient number of via holes should be used to connect the top and bottom ground planes. The evaluation circuit board shown is available from Hittite upon request.

**Notes:****HMC6787ALC5A**

v01.0314

**GaAs MMIC I/Q UPCONVERTER  
37 - 40 GHz**

## Looking for pricing, stock, or lifecycle information?

Click below to explore more details on WIN SOURCE:

 [View EV1HMC6787ALC5A on WIN SOURCE](#)

 [Analog Devices Inc. Information](#)

## Optimize Your Supply Chain with WIN SOURCE Solutions

-  Global Sourcing Solution
-  Obsolete Management
-  Cost Control Management
-  Shortage Management
-  Alternative Solution
-  Excess Inventory Management