





THE DATASHEET OF SK1010C



SPECIFICATION SHEET

| | |
|--------------------------------|--|
| SPECIFICATION SHEET NO. | N1230- SMCSK1010S1010 |
| DATE | Dec.30, 2021 |
| REVISION | A0 |
| DESCRIPTION | SMD Schottky Barrier Rectifier, 2 Pads, SMC/DO-214AB series, SK1010C Type Reverse Voltage 100V Max. Forward Current 10A Max. Operating Temp. Range -55°C ~+150°C, Package in Tape/Reel, 3000pcs/Reel RoHS/RoHS III compliant |
| CUSTOMER | |
| CUSTOMER PART NUMBER | |
| CROSS REF. PART NUMBER | |
| ORIGINAL PART NUMBER | MDD SK1010C |
| PART CODE | SMCSK1010S1010 |

| | | | |
|-------------------------|---|--|---|
| VENDOR APPROVE | | | |
| Issued/Checked/Approved |  |  |  |
| DATE: Dec.30, 2021 | | | |

| | |
|-------------------------|--|
| CUSTOMER APPROVE | |
| | |
| DATE: | |

1/15/2022

SMD SCHOTTKY BARRIER RECTIFIER SMC SERIES



MAIN FEATURE

- The plastic package carries Underwriters Laboratory Flammability Classification 94V-0
- Low reverse leakage
- Built-in strain relief
- Low power loss, high efficiency
- High forward surge current capability
- High temperature soldering guaranteed: 250°C/ 10 seconds at terminals
- Metal silicon junction, majority carrier conduction

APPLICATION

- For surface mounted applications

RFQ

[Request For Quotation](#)

PART CODE GUIDE

| SMC | SK1010 | S | 1010 |
|-----|--------|---|------|
| 1 | 2 | 3 | 4 |

- 1) **SMC**: SMD Schottky Barrier Rectifier, 2 Pads, Package SMC/DO-214AB series
- 2) **SK1010**: Type code for original part number SK1010C
- 3) **S**: Package code, Tape/Reel, 3000pcs/reel.
- 4) **1010**: Specification code for Reverse Voltage 100V Max. Forward Current 10A Max.

SMD SCHOTTKY BARRIER RECTIFIER SMC SERIES

DIMENSION (Unit: Inch/mm)

Image for reference



Marking: SK1010

SMC/DO-214AB

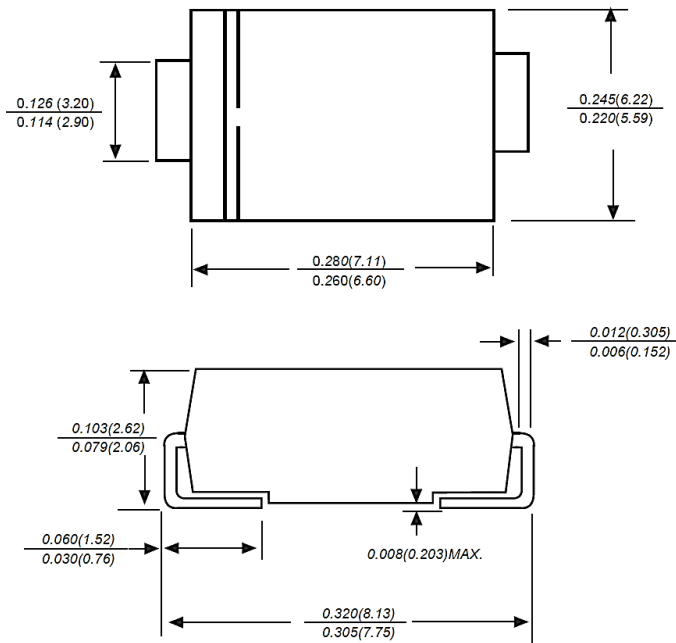

Recommend Pad Layout

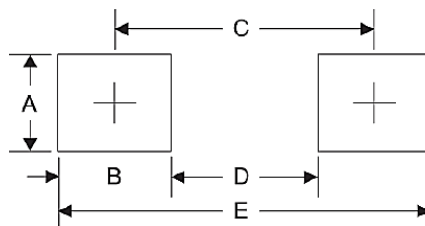

| Symbol | Unit (inch) | Unit (mm) |
|--------|-------------|-----------|
| A | 0.170 | 4.30 |
| B | 0.160 | 4.10 |
| C | 0.311 | 7.90 |
| D | 0.150 | 3.80 |
| E | 0.472 | 12.0 |

SMD SCHOTTKY BARRIER RECTIFIER SMC SERIES
MECHANICAL DATA

| Case | Terminals | Polarity | Mounting Position | Weight per piece |
|--|--|---------------------------------|-------------------|----------------------------|
| JEDEC SMC/DO-214AB molded plastic body | Solder plated, Solderable per MIL-STD-750, Method 2026 | Polarity symbol marking on case | Any | 0.0070 Ounce, 0.2180 grams |

MAX. RATING & CHARACTERISTICS

| Parameter | SYMBOLS | VALUE | | | UNITS |
|--|------------------|-------|---------|------|-------|
| | | Min. | Typical | Max. | |
| Repetitive peak reverse voltage | V _{RRM} | | | 100 | Volts |
| RMS voltage | V _{RMS} | | | 70 | Volts |
| DC blocking voltage | V _{DC} | | | 100 | Volts |
| Average forward output rectified current at TL (see fig.1) | I _{AV} | | | 10 | A |
| Peak forward surge current 8.3ms single half sine-wave superimposed on rated load (JEDEC Method) | I _{FSM} | | 250 | | A |
| Instantaneous forward voltage at 10.0A | V _F | | | 0.85 | Volts |
| DC reverse current at rated DC blocking voltage | I _R | | | 1.0 | mA |
| | | | | 20 | mA |
| Junction capacitance (NOTE 2) | C _J | | 500 | | pF |
| Thermal resistance (Note 3) | R _{QJA} | | 18 | | °C/W |
| Operating junction temperature range | T _J | -55 | | +150 | °C |
| Storage temperature range | T _{STG} | -55 | | +150 | °C |

Note

1. Ratings at 25 C ambient temperature unless otherwise specified. Single phase half-wave 60Hz, resistive or inductive load, for capacitive load current derate by 20%.
2. Measured at 1.0MHz and applied reverse voltage of 4.0Voltage
3. P.C.B. mounted with 0.2x0.2"(5.0x5.0mm) copper pad areas.

SMD SCHOTTKY BARRIER RECTIFIER SMC SERIES
RELIABILITY

| Number | Experiment Items | Experiment Method And Conditions | Reference Documents |
|--------|------------------------------------|--|---------------------------------|
| 1 | Solder Resistance Test | Test 250°C± 5°C for 10 ± 2 sec. Immerse body into solder 1/16" ± 1/32" | MIL-STD-750D METHOD-2031.2 |
| 2 | Solderability Test | 230°C ±5°C for 5 sec. | MIL-STD-750D METHOD-2026.1 0 |
| 3 | Pull Test | 1 kg in axial lead direction for 10 sec. | MIL-STD-750D METHOD-2036.4 |
| 4 | Bend Test | 0.5Kg Weight Applied To Each Lead, Bending Arcs 90 °C ± 5 °C For 3 Times | MIL-STD-750D METHOD-2036.4 |
| 5 | High Temperature Reverse Bias Test | TA=100°C for 1000 Hours at VR=80% Rated VR | MIL-STD-750D METHOD-1038.4 |
| 6 | Forward Operation Life Test | TA=25°C Rated Average Rectified Current | MIL-STD-750D METHOD-1027.3 |
| 7 | Intermittent Operation Life Test | On state: 5 min with rated IRMS Power Off state: 5 min with Cool Forced Air. On and off for 1000 cycles. | MIL-STD-750D METHOD-1036.3 |
| 8 | Pressure Cooker Test | 15 PSIG, TA=121°C, 4 hours | MIL-S-19500 APPENOIXC |
| 9 | Temperature Cycling Test | -55°C~+125°C; 30 Minutes For Dwelled Time 5 minutes for transferred time. Total: 10 cycles. | MIL-STD-750D METHOD-1051.7 |
| 10 | Thermal Shock Test | 0°C for 5 minutes., 100°C for 5minutes, Total: 10 cycles | MIL-STD-750D METHOD-1056.7 |
| 11 | Forward Surge Test | 8.3ms Single Sale Sine-wave One Surge. | MIL-STD-750D METHOD-4066.4 |
| 12 | Humidity Test | TA=65°C, RH=98% for 1000 hours. | MIL-STD-750D METHOD-1021.3 |
| 13 | High Temperature Storage life Test | 150°C for 1000 Hours | MIL-STD-750D METHOD-1031.5 |

SMD SCHOTTKY BARRIER RECTIFIER SMC SERIES

SUGGESTED REFLOW PROFILE (For Reference Only)

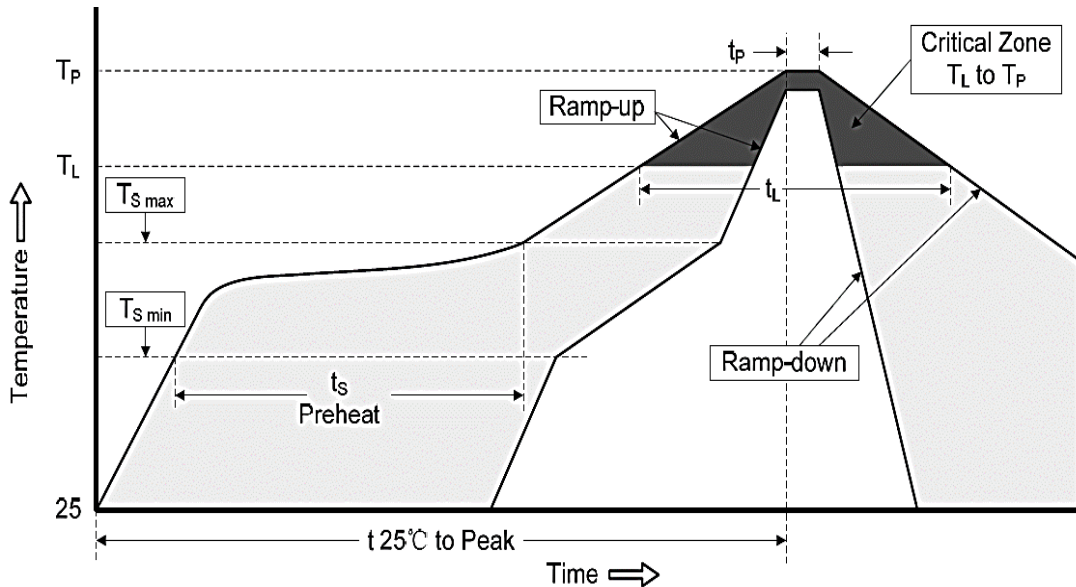

| | | |
|--|----------------------------------|-------------------|
| Profile Feature | | Pb-Free Assembly |
| Average Ramp-up Rate (Ts Max to Tp) | | 3°C/second Max |
| Preheat | Temperature Min (Ts Min.) | 150°C |
| | Temperature Max (Ts Max.) | 200°C |
| | Time (ts Min. to ts Max.) | 60 ~ 180 seconds |
| Time maintained above | Temperature (Tl) | 217°C |
| | Time (tL) | 60 ~ 150 seconds |
| Peak/Classification Temperature (Tp) | | 250 °C |
| Time within 5°C of actual Peak Temperature (tp) | | 10 seconds |
| Ramp-down rate | | 6 °C /Second Max. |
| Time 25 °C to Peak Temperature | | 6 minutes Max. |
| Suggest reflow times | | 3 Times Max. |

SMD SCHOTTKY BARRIER RECTIFIER SMC SERIES

RATINGS AND CHARACTERISTIC CURVES (For Reference Only)

Figure 1
Typical Forward Characteristics

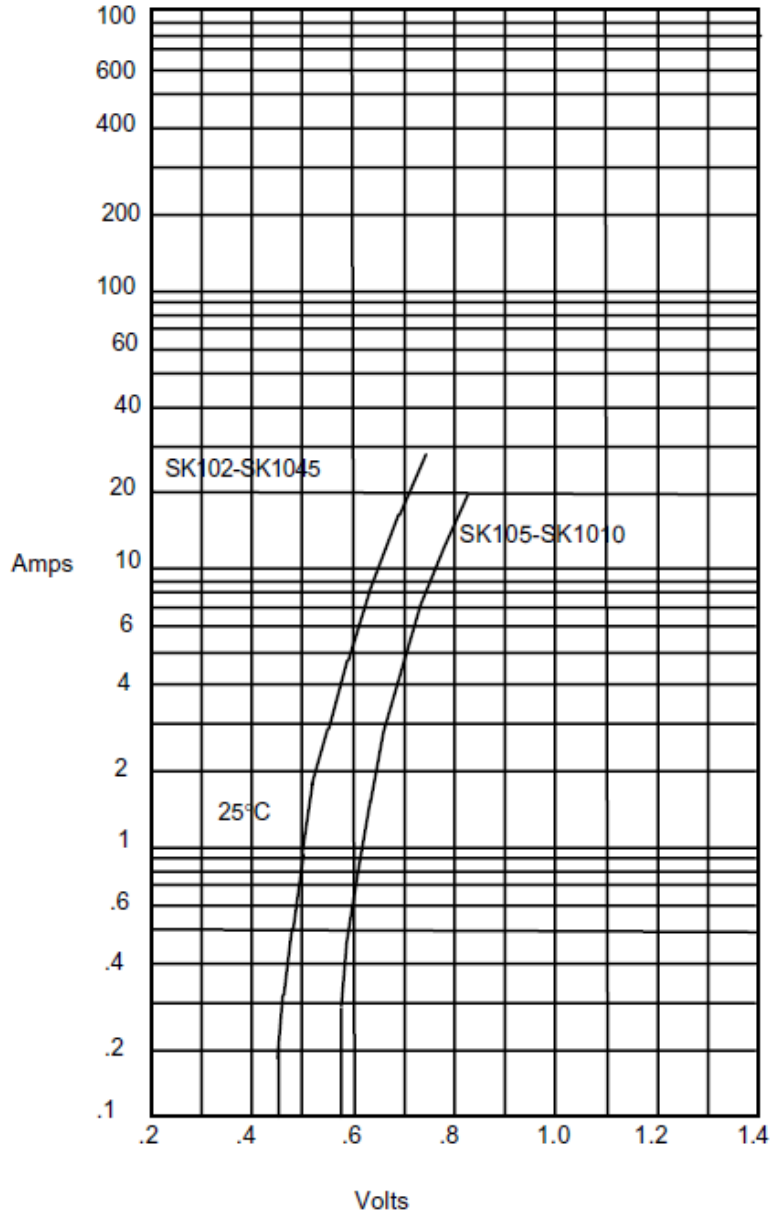

Instantaneous Forward Current - Amperes *versus*
Instantaneous Forward Voltage - Volts

SMD SCHOTTKY BARRIER RECTIFIER SMC SERIES

RATINGS AND CHARACTERISTIC CURVES (For Reference Only)

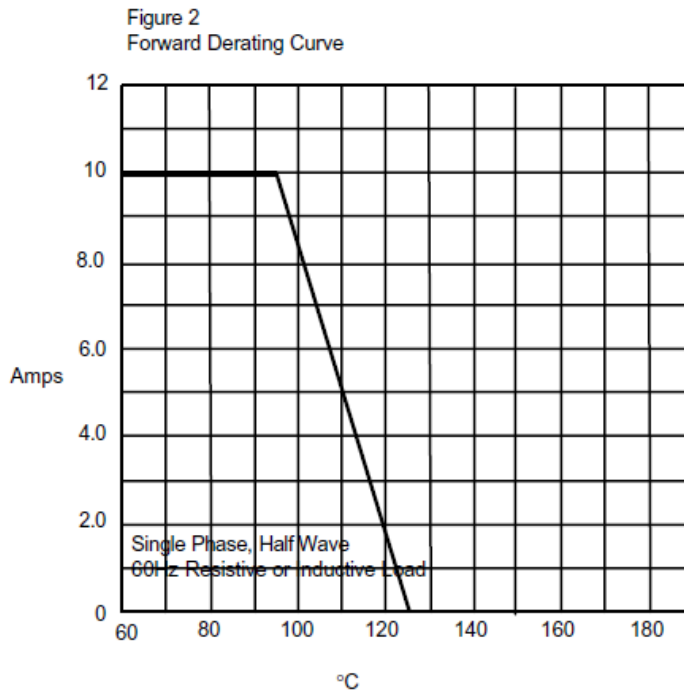

Average Forward Rectified Current - Amperes versus
Lead Temperature - C

Figure 3
Junction Capacitance

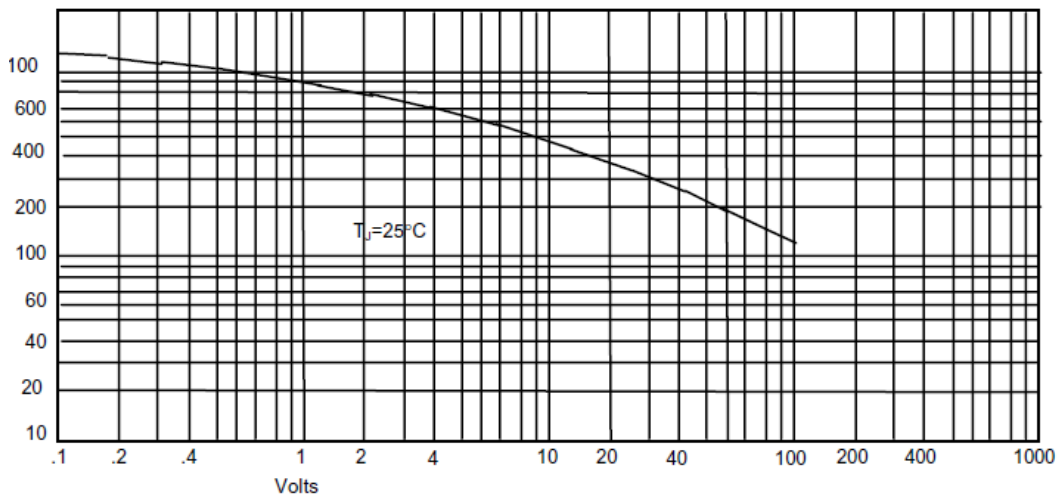

Junction Capacitance - pF versus

SMD SCHOTTKY BARRIER RECTIFIER SMC SERIES

RATINGS AND CHARACTERISTIC CURVES (For Reference Only)

Figure 4
Typical Reverse Characteristics

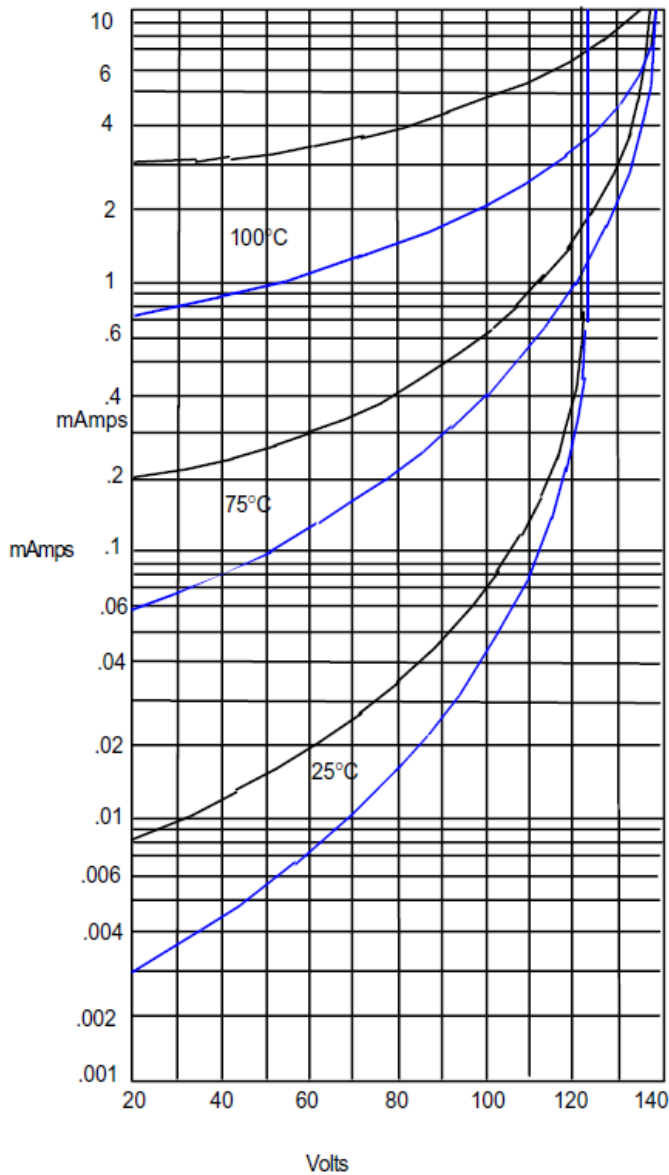

Instantaneous Reverse Leakage Current - MicroAmperes versus
Percent Of Rated Peak Reverse Voltage - Volts

| | |
|--------------|---|
| SK102-SK1045 | — |
| SK105-SK1010 | — |

SMD SCHOTTKY BARRIER RECTIFIER SMC SERIES

RATINGS AND CHARACTERISTIC CURVES (For Reference Only)

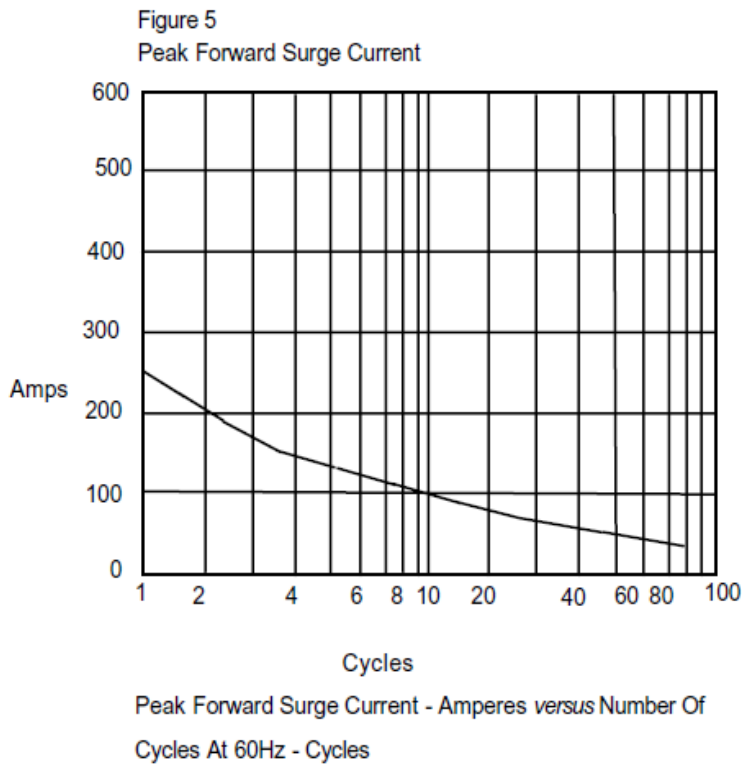

SMD SCHOTTKY BARRIER RECTIFIER SMC SERIES

TAPE/REEL (Unit: mm)

All Devices are packed in accordance with EIA standard RS-481-A and specifications.

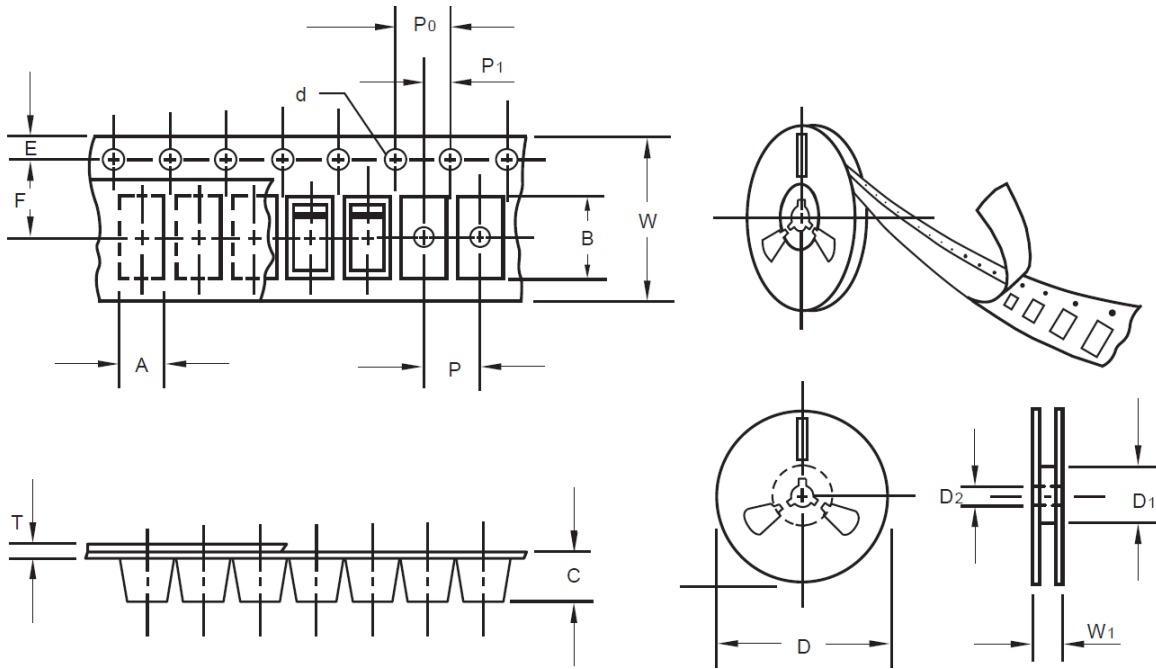

| Item | Symbol | Tolerance | SMC/DO-214AB |
|---------------------------|--------|-----------|--------------|
| Carrier width | A | 0.1 | 6.15 |
| Carrier Length | B | 0.1 | 8.41 |
| Carrier Depth | C | 0.1 | 2.42 |
| Sprocket hole | d | 0.05 | 1.50 |
| 13" Reel outside diameter | D | 2.0 | 330.00 |
| 13" Reel inner diameter | D1 | Min. | 50.00 |
| 7" Reel outside diameter | - | - | - |
| 7" Reel inner diameter | - | - | - |
| Feed hole diameter | D2 | 0.5 | 13.00 |
| Sprocket hole position | E | 0.1 | 1.75 |
| Punch hole position | F | 0.1 | 7.50 |
| Punch hole pitch | P | 0.1 | 8.00 |
| Sprocket hole pitch | P0 | 0.1 | 4.00 |
| Embossment center | P1 | 0.1 | 2.00 |
| Overall tape thickness | T | 0.1 | 0.25 |
| Tape width | W | 0.3 | 16.00 |
| Reel width | W1 | 1.0 | 16.50 |

SMD SCHOTTKY BARRIER RECTIFIER SMC SERIES

PACKAGE For Reference



| | |
|------------------|----------|
| Case Code | SMC |
| Reel Size | 13" |
| Reel Size | 330 mm |
| MPQ/Reel | 3000 pcs |
| Qty. /Box | 6000 pcs |
| G.W/Box | 6 lbs |

DISCLAIMER





NextGen Component, Inc. reserves the right to make changes to the product(s) and or information contained herein without notice. No liability is assumed as a result of their use or application. No rights under any patent accompany the sale of any such product(s) or information

Looking for pricing, stock, or lifecycle information?

Click below to explore more details on WIN SOURCE:

-  [View SK1010C on WIN SOURCE](#)
-  [MDD Information](#)

Optimize Your Supply Chain with WIN SOURCE Solutions

-  Global Sourcing Solution
-  Obsolete Management
-  Cost Control Management
-  Shortage Management
-  Alternative Solution
-  Excess Inventory Management